

Model: **XK-4**
DRAWBAR KEYBOARD

Thank you, and congratulations on your choice of the Hammond XK-4 Drawbar Keyboard.

The Hammond XK-4 features the sound and playability of the authentic Hammond Organ, Transistor Organs, and Pipe Organs into a 61 notes, single manual keyboard.

Please take the time to read this Manual completely in order to take full advantage of the many features of your XK-4, and please retain it for future reference.

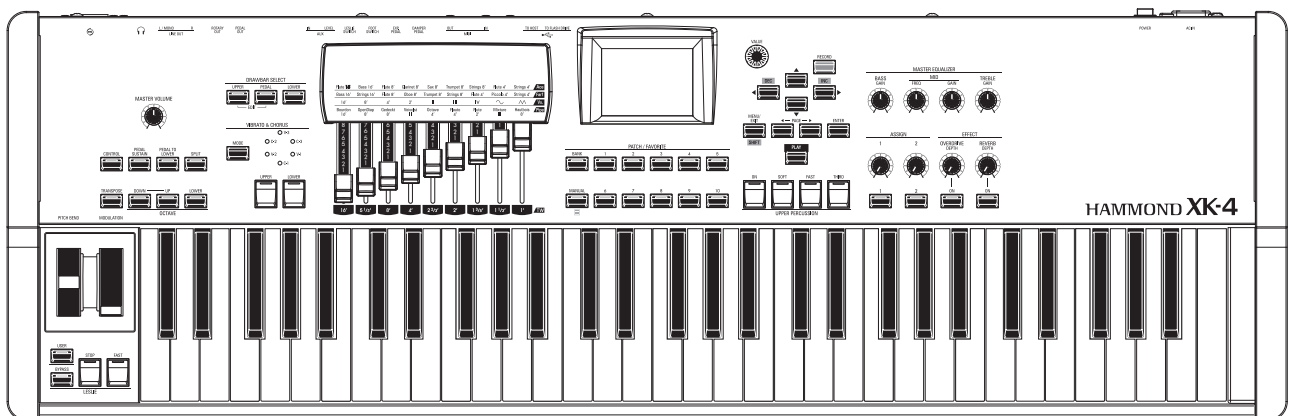

Owner's Manual

IMPORTANT SAFETY INSTRUCTIONS

Read these instructions.

Keep these instructions.

Heed all warnings.

Follow all instructions.

Do not use this apparatus near water.

Clean only with dry cloth.

Do not block any ventilation openings.

Install in accordance with the manufacturer's instructions.

Do not install near any heat sources such as radiators, heat registers, stoves or other apparatus (including amplifiers) that produce heat.

Do not defeat the safety purpose of the polarized or grounding-type plug. A polarized plug has two blades with one wider than the other. A grounding type plug has two blades and a third grounding prong. The wider blade or third prong is provided for your safety. If the provided plug does not fit into your outlet, consult an electrician for replacement of the obsolete outlet.

Protect the power cord from being walked on or pinched, particularly at plugs, convenience receptacles, and the point where they exit from the apparatus.

Only use attachments/accessories specified by the manufacturer.

Use only with the cart, stand, tripod, bracket, or table specified by the manufacturer, or sold with the apparatus. When cart is used: use caution when moving the cart/apparatus combination to avoid injury from tip-over.

PORTABLE CART WARNING



S3125A

Unplug this apparatus during lightning storms, or when unused for long periods of time.

Refer all servicing to qualified service personnel. Servicing is required when the apparatus has been damaged in any way, such as power-supply cord or plug is damaged, liquid has been spilled or objects have fallen into the apparatus, the apparatus has been exposed to rain or moisture, does not operate normally, or has been dropped.

Apparatus shall not be exposed to dripping or splashing and no objects filled with liquids, such as vases, shall be placed on the apparatus.



WARNING: To reduce the risk of fire or electric shock, do not expose this apparatus to rain or moisture.

ATTENTION: Pour réduire les risques de choc électrique ou d'incendie, ne pas exposer cet appareil à la pluie ou à l'humidité.

-THIS APPARATUS MUST BE EARTHED.

-The socket-outlet shall be installed near the apparatus and shall be easily accessible.



	The lightning flash with arrowhead symbol within an equilateral triangle, indicates that dangerous voltage constituting a risk of electric shock is present within this unit.
	The exclamation point within equilateral triangle, indicates that there are important operating and maintenance instructions in the literature accompanying this unit.

For the USA



NOTE: This equipment has been tested and found to comply with the limits for a Class B digital unit, pursuant to part 15 of the FCC rules. These limits are designed to provide reasonable protection against harmful interference in a residential installation. This equipment generates, uses and can radiate radio frequency energy and, if not installed and used in accordance with the instructions, may cause harmful interference to radio communications. However, there is no guarantee that interference will not occur in a particular installation. If this equipment does cause harmful interference to radio or television reception, which can be determined by turning the equipment off and on, the user is encouraged to try to correct the interference by one or more of the following measures:

- ◆ Reorient or relocate the receiving antenna.
- ◆ Increase the separation between the equipment and receiver.
- ◆ Connect the equipment into an outlet on a circuit different from that to which the receiver is connected.
- ◆ Consult the dealer or an experienced radio/TV technician for help.

For CANADA

This class B digital apparatus complies with Canadian ICES-003.

Cet appareil numérique de la classe B est conforme à la norme NMB-003 du Canada.

For EU countries



In case in the future your instrument gets too old to play/use or malfunctions beyond repair, please observe the instructions of this mark, or, if any question, be sure to contact your dealer or your nearest town or municipal office for its proper disposal.

For UNITED KINGDOM

FOR YOUR SAFETY, PLEASE READ THE FOLLOWING TEXT CAREFULLY

This appliance is supplied with a molded 3-pin mains plug for your safety and convenience.

The plug contains a 13 amp fuse.

Should the fuse need to be replaced, please ensure that the replacement fuse has a rating of 13 amps and that it is approved by ASTA or BSI to BS11362.

Check for the ASTA mark  or the BSI mark  on the body of the fuse.

If the plug contains a removable fuse cover, you must ensure that it is refitted when the fuse is replaced.

If the fuse cover is lost, the plug must not be used until a replacement cover is obtained.

A replacement fuse cover can be obtained from your local Hammond Dealer.

IF THE FITTED MOULDED PLUG IS UNSUITABLE FOR THE SOCKET OUTLET IN YOUR HOME, THEN THE FUSE SHOULD BE REMOVED AND THE PLUG CUT OFF AND DISPOSED OF SAFELY.

THERE IS A DANGER OF SEVERE ELECTRICAL SHOCK IF THE CUT-OFF PLUG IS INSERTED INTO ANY 13 AMP SOCKET.

To replace the fuse, open the fuse compartment with a screwdriver and replace the fuse and fuse cover.

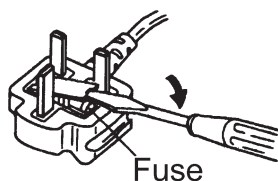

IMPORTANT - PLEASE READ

Power Supply

1. Do not use this unit on the same power circuit with any device that will generate line noise (such as an electric motor or variable lighting system).
2. Before connecting this unit to other devices, turn off the power to all units. This will help prevent malfunctions and/or damage to speakers or other devices.
3. This unit features an Auto Power Off function that automatically turns the power off if the unit is not operated for a specified period of time. The setting will revert to its default value if not backed up before the power is turned off.

Placement

1. Using the unit near power amplifiers (or other equipment containing large power transformers) may induce hum. To alleviate the problem, change the orientation of this unit; or move it farther away from the source of interference.
2. This device may interfere with radio and television reception. Do not use this device in the vicinity of such receivers.
3. Noise may be produced if wireless communications devices, such as cell phones, are operated in the vicinity of this unit. Such noise could occur when receiving or initiating a call, or while conversing. Should you experience such problems, you should relocate such wireless devices so they are at a greater distance from this unit, or switch them off.
4. Do not expose the unit to direct sunlight, place it near devices that radiate heat, leave it inside an enclosed vehicle, or otherwise subject it to temperature extremes. Also, do not allow lighting devices that normally are used while their light source is very close to the unit (such as a piano light), or powerful spotlights to shine upon the same area of the unit for extended periods of time. Excessive heat can deform or discolor the unit.
5. When moved from one location to another where the temperature and/or humidity is very different, water droplets (condensation) may form inside the unit. Damage or malfunction may result if you attempt to use the unit in this condition. Therefore, before using the unit, you must allow it to stand for several hours, until the condensation has completely evaporated.
6. Do not allow rubber, vinyl, or similar materials to remain on the unit for long periods of time. Such objects can discolor or otherwise harmfully affect the finish.
7. Do not paste stickers, decals, or the like to this instrument. Peeling such matter off the instrument may damage the exterior finish.

Maintenance

8. To clean the unit, use a dry, soft cloth; or one that is slightly dampened.
9. To remove stubborn dirt off plastic parts, use a cloth impregnated with a mild, non-abrasive detergent. Afterwards, be sure to wipe the unit thoroughly with a soft, dry cloth. Try to wipe the entire surface using an equal amount of strength, moving the cloth along with the grain of the wood. Rubbing too hard in the same area can damage the finish.
10. Never use benzene, thinners, alcohol or solvents of any kind, to avoid the possibility of discoloration and/or deformation.

Additional Precautions

1. Please be aware that the contents of memory can be irretrievably lost as a result of a malfunction, or the improper operation of the unit. To protect yourself against the risk of losing important data, we recommend that you periodically save a backup copy of important data you have stored in the unit's memory in USB Flash Drive.
2. Unfortunately, it may be impossible to restore the contents of data that was stored in another MIDI device (e.g., a sequencer) once it has been lost. Hammond assumes no liability concerning such loss of data.
3. Use a reasonable amount of care when using the unit's buttons, sliders, or other controls; and when using its jacks and connectors. Rough handling can lead to malfunctions.
4. When connecting / disconnecting all cables, grasp the connector itself - never pull on the cable. This will avoid causing short circuits, or damage to the cable's internal elements.
5. To avoid disturbing your neighbors, try to keep the unit's volume at reasonable levels. You may prefer to use headphones, so you do not need to be concerned about those around you (especially when it is late at night).
6. When you need to transport the unit, package it in the box (including padding) that it came in, if possible. Otherwise, you will need to use equivalent packaging materials.

Trademark

All product names mentioned in this document are trademarks or registered trademarks of their respective owners.



INTRODUCTION

Table Of Contents

IMPORTANT SAFETY INSTRUCTIONS.....	2	USING CONTROLLERS	28
IMPORTANT - PLEASE READ.....	4	INTERNAL CONTROLLERS	28
INTRODUCTION	5	EXPRESSION PEDAL	28
NAMES AND FUNCTIONS	10	FOOT SWITCH.....	28
CONTROL PANEL.....	10	DAMPER PEDAL.....	28
LEFT SIDE OF THE KEYBOARD	12	LESLIE SWITCH.....	28
ACCESSORY PANEL.....	12	MASTER EQUALIZER	29
KEYBOARD	14	CREATE YOUR OWN SETTING	30
ACCESSORY	14	SELECT "MANUAL".....	30
ACCESSORIES (SOLD SEPARATELY).....	14	INITIALIZE "MANUAL".....	30
MAKING THE CONNECTIONS	15	SELECT A PART.....	31
BASIC CONNECTIONS	16	PULL OUT THE DRAWBARS.....	31
CONNECTING A LESLIE SPEAKER	17	ADD PERCUSSION	31
BASIC CONNECTIONS.....	17	ADD EFFECTS	31
SINGLE-CHANNEL TYPE (122XB, 122H, 981 or 3300/W).....	17	VIBRATO & CHORUS.....	31
3-CHANNEL TYPE (2101/mk2)	17	LESLIE	31
OTHER AUDIO CONNECTIONS	18	RECORDING A PATCH	32
OUTPUTTING DRY ORGAN SOUNDS	18	USING THE [VALUE] KNOB.....	32
ROTARY OUT jack.....	18	USING THE NUMBER BUTTONS	32
PEDAL OUT jack.....	18	NAMING AND RECORDING	32
USING A MUSIC PLAYER	19	SETTING UP	33
AUX IN jack	19	SOUND ENGINE STRUCTURE	34
EXPANDING THE KEYBOARDS	20	ORGAN SECTION IN DETAIL	36
DUAL MANUAL OPERATION.....	20	ORGAN TYPES	36
TWO MANUALS + PEDALBOARD	21	TONE WHEEL (TW)	36
RECOMMENDED MIDI PEDALBOARDS	21	TRANSISTOR (Vx, Farf, Ace)	36
CONNECTING THE CU-1 LESLIE SWITCH.....	22	PIPE.....	36
TURN ON AND PLAY.....	23	SELECTING ORGAN TYPES	37
POWERING ON.....	24	HARMONIC DRAWBARS™	38
HOW TO POWER ON	24	DRAWBARS (TW: Tone Wheel).....	38
BACKING UP THE INITIAL SETTINGS.....	24	DRAWBARS FOR THE UPPER AND LOWER PARTS.....	39
AUTO POWER OFF	24	PEDAL DRAWBARS	39
RESTORING THE FACTORY SETTINGS.....	24	MATCHING THE REGISTRATION TO THE DRAWBAR SETTING.....	39
STRUCTURE OF THIS INSTRUMENT	25	DRAWBAR REGISTRATION PATTERNS	40
KEYBOARDS AND PARTS	25	MODERN DRAWBAR REGISTRATIONS.....	41
KEYBOARDS.....	25	DRAWBARS (Vx).....	42
PARTS.....	25	DRAWBARS (Farf, Ace).....	43
MEMORY	25	Farf.....	43
PATCHES.....	25	Ace.....	43
FACTORY AND USER.....	25	DRAWBARS (Pipe).....	44
FAVORITES.....	25	F1: Classic 1.....	44
USING PATCHES.....	26	F2: Classic 2.....	44
WHAT IS A "PATCH"?.....	26	F3: Theatre 1.....	45
SELECT A PATCH	26	F4: Theatre 2.....	45
USING THE [VALUE] KNOB.....	26	ORGAN FEATURES AND EFFECTS.....	46
USING THE NUMBER BUTTONS	26	PERCUSSION.....	46
CHANGING THE INPUT METHOD	27	EFFECTS.....	46
		VIBRATO & CHORUS.....	46
		LESLIE	47
		OVERDRIVE, REVERB.....	47
		MULTI EFFECTS.....	47

COMBINING PARTS.....	48	ORGAN	67
KEYBOARD SPLIT.....	48	GENERAL.....	67
USING THE SPLIT FEATURE.....	48	DRAWBARS.....	68
CHANGING THE OCTAVE.....	48	UPPER & LOWER DRAWBARS	68
PEDAL TO LOWER	49	PEDAL	69
USING THE PEDAL TO LOWER	49	CONTACT/SUSTAIN	70
PEDAL SUSTAIN	49	VIRTUAL MULTI-CONTACT.....	70
USING THE PEDAL SUSTAIN	49	SUSTAIN UPPER / LOWER / PEDAL.....	70
RECORDING A USER PATCH.....	50	IMPEDANCE.....	70
USING THE [VALUE] KNOB.....	50	PERCUSSION.....	71
USING THE NUMBER BUTTONS	50	LEVEL	71
NAMING AND RECORDING	50	DECAY	71
TRANSPOSE, TUNE	51	KEYBOARD	71
TRANSPOSE.....	51	DRAWBARS	71
WHAT IS AFFECTED BY THE TRANSPOSE FUNCTION?.....	51	ANIMATION.....	72
MASTER TUNE	51	VIBRATO & CHORUS.....	72
RECORDING "MANUAL" SETTINGS	52	TONE WHEEL ORGAN.....	72
USING THE DISPLAY.....53		PEDAL	72
USING THE DISPLAY	54	TRANSISTOR ORGAN.....	72
PLAY Mode.....	54	PIPE ORGAN	72
MENU Mode.....	54	LESLIE.....	73
FUNCTION Mode.....	54	REVERB	73
LOCKING THE DISPLAY.....	55	CABINET.....	73
PLAY MODE.....	56	EFFECT/EQ	74
PLAY MODES	56	MATCHING TRANSFORMER	74
OPERATION.....	56	M.TRANS (MATCHING TRANSFORMER).....	74
APP (APPLICATION) MENU	56	DEPTH.....	74
HOW TO READ THE DISPLAY (ORGAN)	57	MULTI EFFECT 1	75
HOW TO READ THE DISPLAY (ZONES)	57	MULTI EFFECT 1.....	75
MENU MODE	58	Tremolo.....	75
HOW TO READ THE DISPLAY	58	Wah-Wah	76
OPERATION IN THIS MODE.....	58	Ring Mod.....	77
MENU MODE CONTENTS	59	Compressor	78
FUNCTION MODE.....	60	OVERDRIVE.....	79
HOW TO READ THE DISPLAY	60	MULTI EFFECT 2	80
OPERATION IN THIS MODE.....	60	MULTI EFFECT 2.....	80
APP (APPLICATION) MENU	60	Auto Pan	80
EXAMPLE OF OPERATION	61	Phaser.....	81
"SHORTCUTS"	63	Flanger	81
IF YOU FREQUENTLY USE A CERTAIN PAGE... ..	63	Chorus.....	82
REGISTER	63	Delay.....	83
DISPLAY THE REGISTERED PAGE.....	63	REVERB	84
EDITING PARAMETERS65		PATCH EQUALIZER.....	85
PATCH.....	66	EQUALIZER.....	85
MENU AND CONTENTS.....	66	TONE CONTROL	85
APP (APPLICATION) MENU	66	CONTROLLER	86
ASSIGN	87	PITCH BEND.....	86
ASSIGN 1/2.....	87	MODULATION.....	86
INTERNAL ZONE.....	88	DAMPER.....	86
EXTERNAL ZONE	89	ASSIGN	87
MESSAGE ON/OFF.....	90	ASSIGN 1/2.....	87
PANIC FUNCTION / PARAMETER RELOAD.....	90	INTERNAL ZONE.....	88
		EXTERNAL ZONE	89
		MESSAGE ON/OFF.....	90
		PANIC FUNCTION / PARAMETER RELOAD.....	90

RECORDING A USER PATCH.....	91	GLOBAL	115
USING THE [VALUE] KNOB.....	91	POWER.....	115
USING THE NUMBER BUTTONS.....	91	AUTO OFF.....	115
NAMING AND RECORDING	91	FAVORITE	116
APP MENU JOBS.....	92	PATCH/FAVORITE	116
INITIALIZE PATCH	92	BANK 1 - 10.....	116
REGISTER PAGE TO FAVORITE	92	DISPLAY.....	117
EDITING CUSTOM PARAMETERS	93	RECORDING SYSTEM PARAMETERS	118
CUSTOM CONTENTS.....	93	DEFAULT	119
APP (APPLICATION) MENU	93	INFORMATION	120
CUSTOM TONE WHEELS	94	STATUS DISPLAY.....	120
SET	94	IS ACTIVE	120
GENERAL	94	VERSION - FIRMWARE	120
EACH WHEEL.....	95	VERSION - CONTENTS	120
WOW & FLUTTER	96	UPDATE.....	120
WHEEL ECCENTRICITY	96	UPDATING THE SOFTWARE	121
LEAKAGE WHEEL.....	97	PREPARING OPERATING TIME.....	121
MATRIX LEVEL.....	98	PREPARING UPDATE FILES.....	121
CUSTOM PEDAL REG.	99	PREPARING MEDIA	121
SET	99	UPDATING PROCEDURE	121
EACH PEDAL DRAWBAR.....	99	MIDI	123
CUSTOM LESLIE.....	100	MIDI	124
CABINET NUMBER.....	100	WHAT IS "MIDI"?.....	124
SPEAKER	100	WHAT IS "USB"?.....	124
ROTOR	100	MIDI/USB JACKS ON THE XK-4	124
MICROPHONE SETTINGS	101	WHAT MIDI CAN DO ON THE XK-4.....	124
CUSTOM PIPE	102	USB TO HOST.....	124
SET	102	MIDI CHANNEL	125
UPPER / LOWER / PEDAL STOP SET	102	MAIN MIDI MESSAGES	125
RECORDING A CUSTOM SETTING	104	MIDI STRUCTURE OF THE XK-4	126
SYSTEM.....	105	KEYBOARD (INTERNAL) CHANNELS.....	126
SYSTEM PARAMETERS AND CONTENTS.....	105	EXTERNAL ZONES.....	126
SOUND	106	EXPANDED KEYBOARDS	126
MASTER TUNE.....	106	USING AN EXTERNAL SEQUENCER.....	128
MASTER TRANSPOSE.....	106	RECORDING AND PLAYING BACK A PERFORMANCE.....	128
MASTER EQUALIZER.....	106	RECORD.....	128
AUDIO	107	PLAYBACK	128
AUDIO.....	107	RECORDING A PERFORMANCE VIA USB CABLE.....	128
LESLIE	107	USING A MIDI SOUND MODULE.....	129
CONTROL.....	108	BASIC CONNECTIONS.....	129
FOOT SWITCH	108	SIMPLIFIED SETUP	129
EXPRESSION PEDAL.....	109	RECORDING TO A SEQUENCER OR DAW.....	130
DAMPER.....	110	USING THE MIDI PORTS.....	130
USER.....	111	PLAY BACK THE PERFORMANCE.....	130
TONE WHEEL BRAKE.....	111	USING USB MIDI.....	131
PANEL	112	MIDI FUNCTION MODE.....	132
OCT/XPOSE(TRANSPOSE)	112	MIDI TEMPLATE	132
KNOB/DB(DRAWBARS)	112	GENERAL	132
DISPLAY.....	112	SYSTEM EXCLUSIVE MESSAGES	133
KEYBOARD	113	MIDI CHANNELS.....	133
PATCH LOAD	114		
PATCH LOAD	114		

USING MEMORY	135	SERVICE	165
USING MEMORY	136		
WHAT YOU CAN DO WITH A USB FLASH DRIVE	136		
ABOUT USB FLASH DRIVES.....	136		
COMPATIBLE USB FLASH DRIVES	136		
USB CONNECTOR	136		
FOLDER STRUCTURE	136		
FORMAT	137		
USING SETUP FILES	138		
SAVE	139		
LOAD	140		
DELETE	141		
TROUBLESHOOTING.....	143		
TROUBLESHOOTING.....	144		
TROUBLES.....	144		
ERROR MESSAGES	144		
APPENDIX.....	145		
FACTORY PATCHES	146		
PIPE ORGAN STOPS.....	147		
PIPE ORGAN STOPS.....	147		
MIDI TEMPLATES	148		
MIDI TEMPLATES	148		
MIDI INFORMATION	150		
MIDI IMPLEMENTATION.....	150		
CHANNEL VOICE MESSAGES	150		
CHANNEL MODE MESSAGES.....	150		
DRAWBAR DATA LIST	151		
SYSTEM EXCLUSIVE MESSAGES	151		
MEMORY DUMP	151		
DUMP REQUEST (Rx. Only).....	151		
NRPN SWITCH.....	151		
DATA SET	151		
IDENTITY REQUEST (RX. ONLY).....	151		
IDENTITY REPLY (TX. ONLY)	151		
PATCH PARAMETERS.....	152		
CUSTOM SETS	155		
CUSTOM TONE WHEELS	155		
CUSTOM SUB DRAWBARS	155		
CUSTOM LESLIE CABINETS.....	155		
CUSTOM PIPES	155		
CUSTOM TONE WHEEL PARAMETERS	156		
CUSTOM PEDAL REG. PARAMETERS.....	156		
PIPE PARAMETERS	156		
CUSTOM LESLIE PARAMETERS	157		
SYSTEM PARAMETERS.....	158		
FAVORITES	159		
MIDI IMPLEMENTATION CHART.....	160		
MIDI CHANNELS AND MESSAGES.....	161		
SPECIFICATIONS.....	162		
INDEX.....	163		

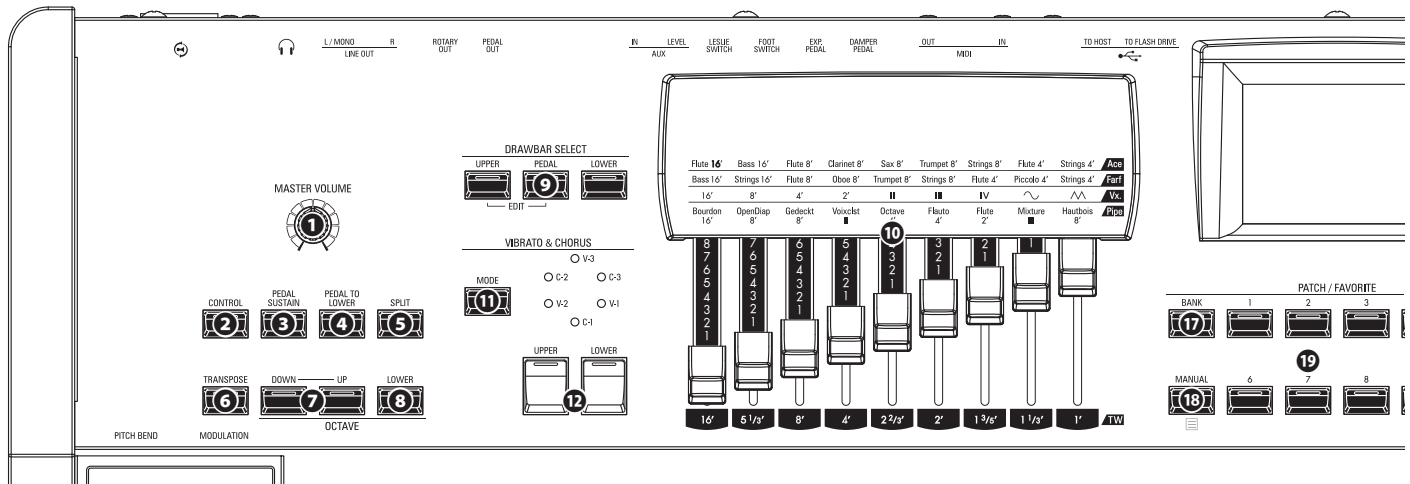

CONTROL PANEL

LEFT SIDE

1 MASTER VOLUME knob

Controls the volume of the entire instrument.

4 CONTROL button (P. 108)

Accesses a feature from the CONTROL FUNCTION Mode.

3 PEDAL SUSTAIN button (P. 49)

Adds a smooth decay to a PEDAL note when it is released.

4 PEDAL TO LOWER button (P. 49)

Couples the entire PEDAL registration, including Parameters, to the LOWER Part.

5 SPLIT button (P. 48)

Divides the keyboard into UPPER (right) and LOWER (left) keyboards.

6 TRANSPOSE button (P. 51)

Transposes the musical pitch of the entire keyboard when used in conjunction with 7.

7 OCTAVE DOWN/UP buttons (P. 48)

Moves the pitch of the UPPER Part "UP" or "DOWN" ± 2 octaves.

8 OCTAVE LOWER button

Moves the pitch of the LOWER Part "UP" or "DOWN" ± 2 octaves when used in conjunction with the [UP] or [DOWN] buttons 7.

DRAWBARS

9 DRAWBAR SELECT buttons

1. Selects which Part the Harmonic Drawbars 10 will affect (P. 31).
2. Matches the Drawbar Registration contained in a Patch with the physical Drawbar setting (P. 39).
3. Opens the editing page ([UPPER] and [PEDAL] buttons pressed together) (P. 68).

10 HARMONIC DRAWBARS (P. 38)

Registers the basic organ tones.

NOTE: The function of the Drawbars is different for each Organ Type.

VIBRATO & CHORUS (P. 46)

Adds richness and warmth to the sound by modulating the Drawbar tones.

11 MODE button

Selects the depth of either the Vibrato or Chorus.

12 UPPER, LOWER button

Turns the Vibrato/Chorus "ON" or "OFF" for the UPPER or LOWER Parts.

UPPER PERCUSSION (P. 46)

Adds Harmonic Percussion (decay) to the UPPER Part.

13 ON button

Adds percussion (decay) to the UPPER Part.

14 SOFT button

Reduces the volume of the Percussion.

15 FAST button

Causes the Percussion tone to decay more rapidly.

16 THIRD button

Switches the harmonic between second (4') and third (2 2/3').

PATCH/FAVORITE

17 BANK button (P. 26)

Selects Favorite Banks by Pressing and Holding this button with one of the NUMBER buttons 19.

18 MANUAL/APP button

1. Overrides the current Patch setting in favor of the current Panel settings. (P. 30)
2. Opens the APP (Application) Menu. (P. 56)

19 NUMBER buttons

1. Recalls a Patch (P. 26) or Favorite (P. 116) which is assigned to a numbered button.
2. Inputs characters or numbers in a Dialog Box.

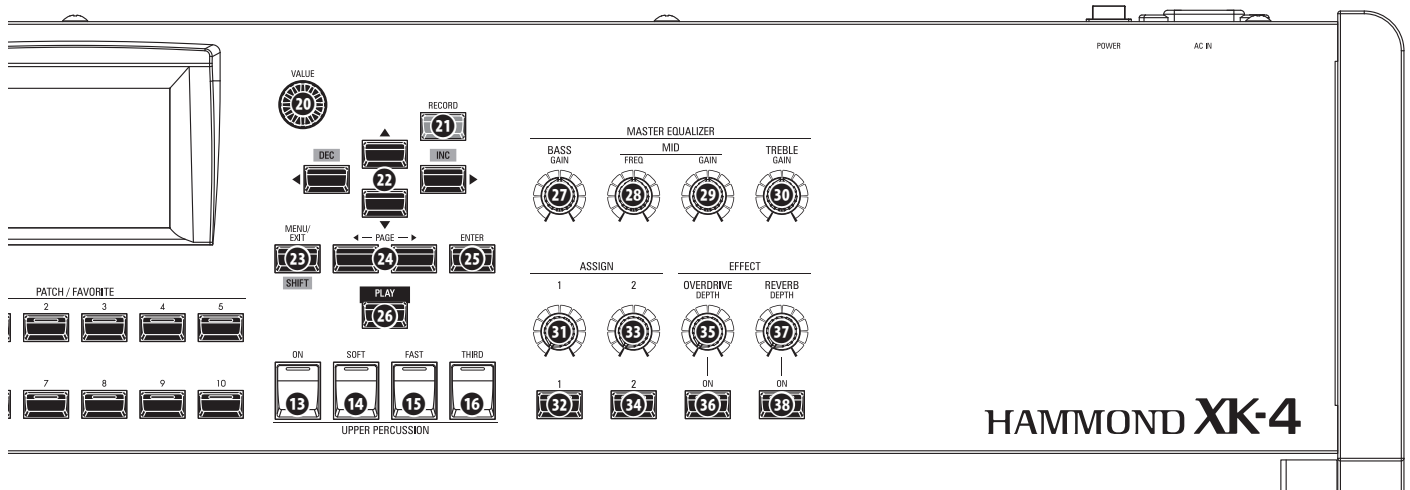

INFORMATION CENTER

- 20 VALUE knob**
Increments or decrements Patch numbers while performing, or adjusts values during editing.
Press and Hold the [SHIFT] button **23** to change values by larger degrees.
- 21 RECORD button**
Use this button to Record user-definable features such as Patches, Custom Parameters etc.
- 22 DIRECTION / DEC / INC buttons**
- Moves the cursor in the display.
 - Increments or decrements a value while Pressing and Holding the [SHIFT] button **23**.
- 23 MENU / EXIT / SHIFT button**
- Opens the MENU Mode (P. 58).
 - Exits or goes back one level from the current Page.
 - Allows alternate functions for designated buttons.
- 24 PAGE buttons**
Use these buttons to navigate the EDIT and FUNCTION Mode Pages.
- 25 ENTER button**
Use this button to confirm the current entry or procedure when editing sounds or features.
- 26 PLAY button**
Returns to the PLAY Mode. (P. 56)

MASTER EQUALIZER (P. 106)

- Adjusts the overall tone of this instrument.
- 27 BASS knob**
Adjusts the gain of the bass range.
- 28 MID FREQUENCY knob**
Adjusts the frequency of the middle range.
- 29 MID GAIN knob**
Adjusts the gain of the middle range.
- 30 TREBLE knob**
Adjusts the gain of the treble range.

ASSIGN (P. 87)

- Assigns a Parameter and controls a value.
- 31 "1" knob**
Controls a continuous Parameter.
- 32 "1" button**
Controls a switchable Parameter.
- 33 "2" knob**
Controls a continuous Parameter.
- 34 "2" button**
Controls a switchable Parameter.

EFFECT (P. 47)

- 35 OVERDRIVE DEPTH knob**
Adjusts the depth of the Overdrive effect.
- 36 OVERDRIVE ON button**
Turn the Overdrive "ON" or "OFF"
- 37 REVERB DEPTH knob**
Adjusts the depth of the Reverb effect.
- 38 REVERB ON button**
Turns the Reverb "ON" or "OFF"

LEFT SIDE OF THE KEYBOARD

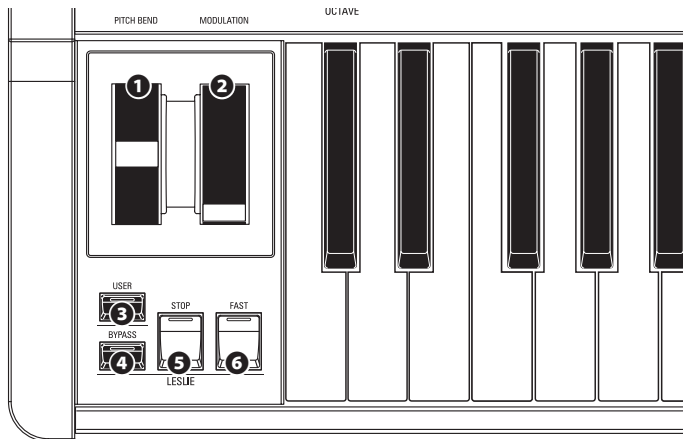

WHEELS

1 PITCH BEND wheel (P. 28)

Bends the pitch of played notes “UP” or “DOWN.”

2 MODULATION wheel

1. Applies modulation to the external MIDI devices (P. 89).
2. Controls the amount of various effects (P. 86).

USER

3 USER button (P. 111)

Switches or triggers an assigned function.

LESLIE (P. 47)

23 LESLIE BYPASS button

Channels the sounds produced by the Drawbars from the Rotary channel to the Stationary channel.

24 LESLIE STOP button

Stops the Leslie Rotors from turning when the [FAST] button is OFF.”

25 LESLIE FAST button

Selects “FAST” Leslie Rotor speed.

ACCESSORY PANEL

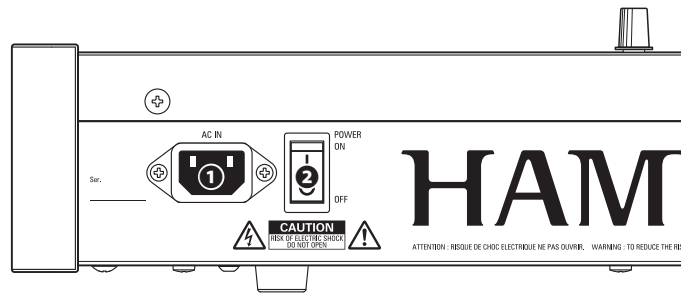

POWER

1 AC POWER RECEPTACLE

Connect the female end of a grounded AC Power Cord here, and the male end into a grounded AC power outlet.

2 POWER switch

Turns the AC power to the instrument “ON” or “OFF”

AUDIO OUTPUT JACKS

3 PHONES jack

Use this jack to connect a set of stereo headphones.

NOTE: Connecting Headphones does NOT mute the LINE OUT or LESLIE audio outputs. If you wish the sound to go through the Headphones only, disconnect all other audio outputs.

4 LINE OUT L/MONO jack

LINE OUT R jack

Use these jacks to connect external audio equipment.

If the connected mixer or monitor speaker is stereophonic, connect both the L and R jacks. If it is monaural, connect only the L/MONO jack.

5 Leslie® LESLIE 11 -PIN socket (P. 17)

Use to connect a Leslie Speaker Cabinet having an 11-pin interface.

When a Leslie Speaker Cabinet is detected at the 11-pin socket, the inbuilt digital Leslie is disabled at the PHONES jack and the LINE OUT jacks.

6 ROTARY OUT jack (P. 18)

Outputs the Rotary Channel of the Drawbars. Use this jack to bypass the inbuilt digital Leslie if you want a “dry” audio output from the Drawbars.

NOTE: Set the “ROTARY OUT” switch in the AUDIO portion of the FUNCTION Mode to “Used” if you use this jack (P. 107).

7 PEDAL OUT jack (P. 18)

Outputs the PEDAL Part. Use this jack to connect a powered sub-woofer to increase the bass, or to bypass the Leslie to the PEDAL Part.

NOTE: Set the “PEDAL OUT” switch in the AUDIO portion of the FUNCTION Mode to “Used” if you use this jack (P. 107).

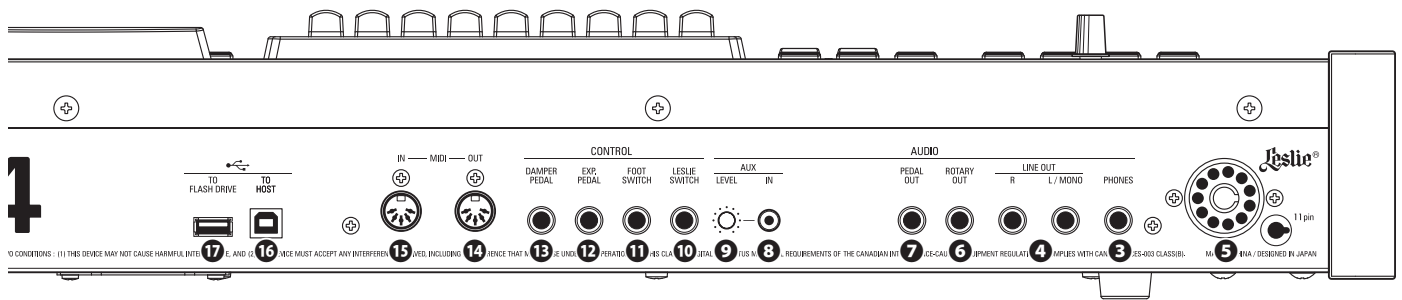

AUDIO INPUT JACK (P. 19)

9 AUX IN jack

Use this jack to connect an external audio source. When connected, the sound will be mixed with the internal keyboard sounds and sent out to the LINE OUT jacks and the Stationary channel of a multi-channel Leslie Speaker via the 11-pin socket.

10 AUX LEVEL knob

Adjusts the volume of the sound coming in from the AUX IN jack.

CONTROLLER JACKS

10 LESLIE SWITCH jack (P. 22)

Connect a Leslie Switch such as CU-1 or FS-10TL (not available in Europe) to switch the Leslie effect.

11 FOOT SWITCH jack (P. 28)

Use this jack to connect a Foot Switch to control functions such as Leslie speeds or Patch changes.

The recommended Foot Switches are listed below:

HAMMOND ... FS-9H, VFP1

BOSS FS-5U

YAMAHA FC4A, FC5

12 EXP. PEDAL jack (P. 28)

Use this jack to connect an Expression Pedal to control volume while playing.

The recommended Expression Pedals and polarities are listed below:

HAMMOND ... EXP-50J, EXP-20, V-20H, V-20R; **NORM**

KORG XVP-10, XVP-20; **REV**

ROLAND EV-5; **NORM**

YAMAHA FC7; **REV**

13 DAMPER PEDAL jack (P. 28)

Use this jack to connect a Damper Pedal (Sustain Pedal) for holding notes when keys are played and released.

The recommended Damper Pedals are listed below:

HAMMOND ... FS-9H, VFP1

ROLAND DP-10

YAMAHA FC3A, FC4A, FC5

MIDI PORTS (P. 124)

14 MIDI OUT Port

Transmits MIDI data to a connected MIDI device.

15 MIDI IN Port

Receives MIDI data from a connected MIDI device.

Note: This port can be programmed for a LOWER Keyboard or a Pedalboard (P. 132).

USB PORTS

16 USB TO HOST Port (P. 124)

Use to connect to a computer to transmit MIDI messages.

17 USB FLASH DRIVE Port (P. 136)

Use to connect a USB Flash Drive to Load or Save files (such as Setups, Patches, etc.) as well as to Update the software.

KEYBOARD

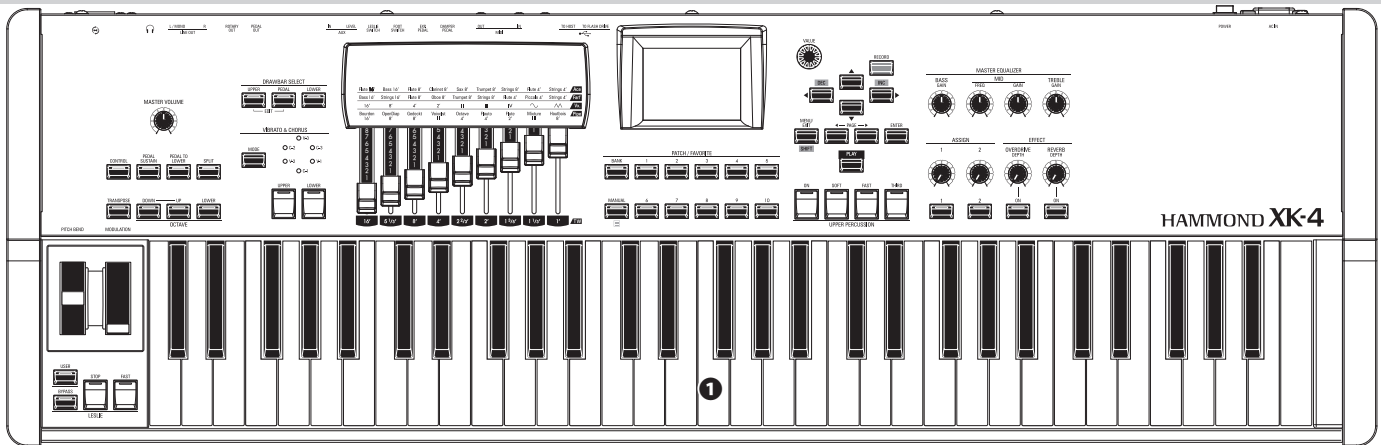

1 Keyboard

61 notes, square-front (“waterfall” type), semi-weighted, velocity-sensitive keyboard.

ACCESSORY

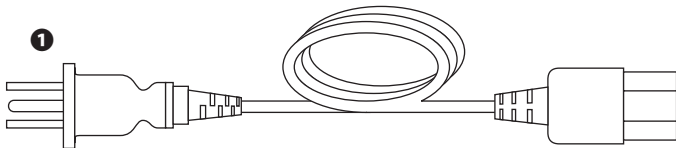

1 AC Power Cord

Connects to the AC Power Receptacle of the instrument.

ACCESSORIES (SOLD SEPARATELY)

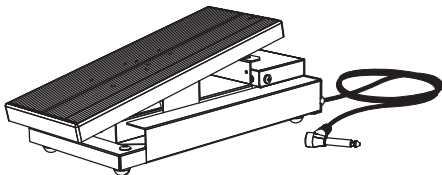

Expression Pedal EXP-50J

Heavyweight pedal for durability, and detachable cable to avoid breaking or fraying.

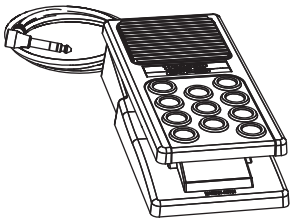

Expression Pedal EXP-20

Light weight for touring use.

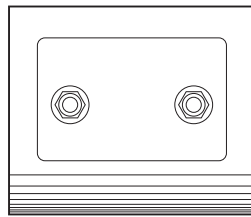

Leslie Switch FS-10TL
(not available in Europe)

Controls both the [ON/OFF] and [SLOW/FAST] of the Leslie Rotors.

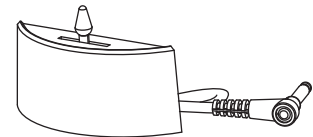

Leslie Switch CU-1 / CU-1BK

Controls [SLOW/STOP/FAST] of the Leslie Rotors.

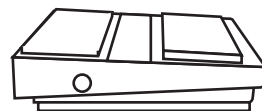

Foot Switch FS-9H

Multi-purpose foot switch with Momentary action (Press for “On” and Release for “Off”).



**MAKING THE
CONNECTIONS**

BASIC CONNECTIONS

Connect audio cables and accessories as shown below.

The XK-4 is not self-contained - an external amplifier/speaker system is required in order to hear the sound. However, if you connect a set of stereo headphones to the PHONES jack, you can hear the sound through the headphones even if an external amplifier is not connected.

NOTE: Be sure that both the instrument and amplifier are "OFF" before connecting amplifiers or headphones.

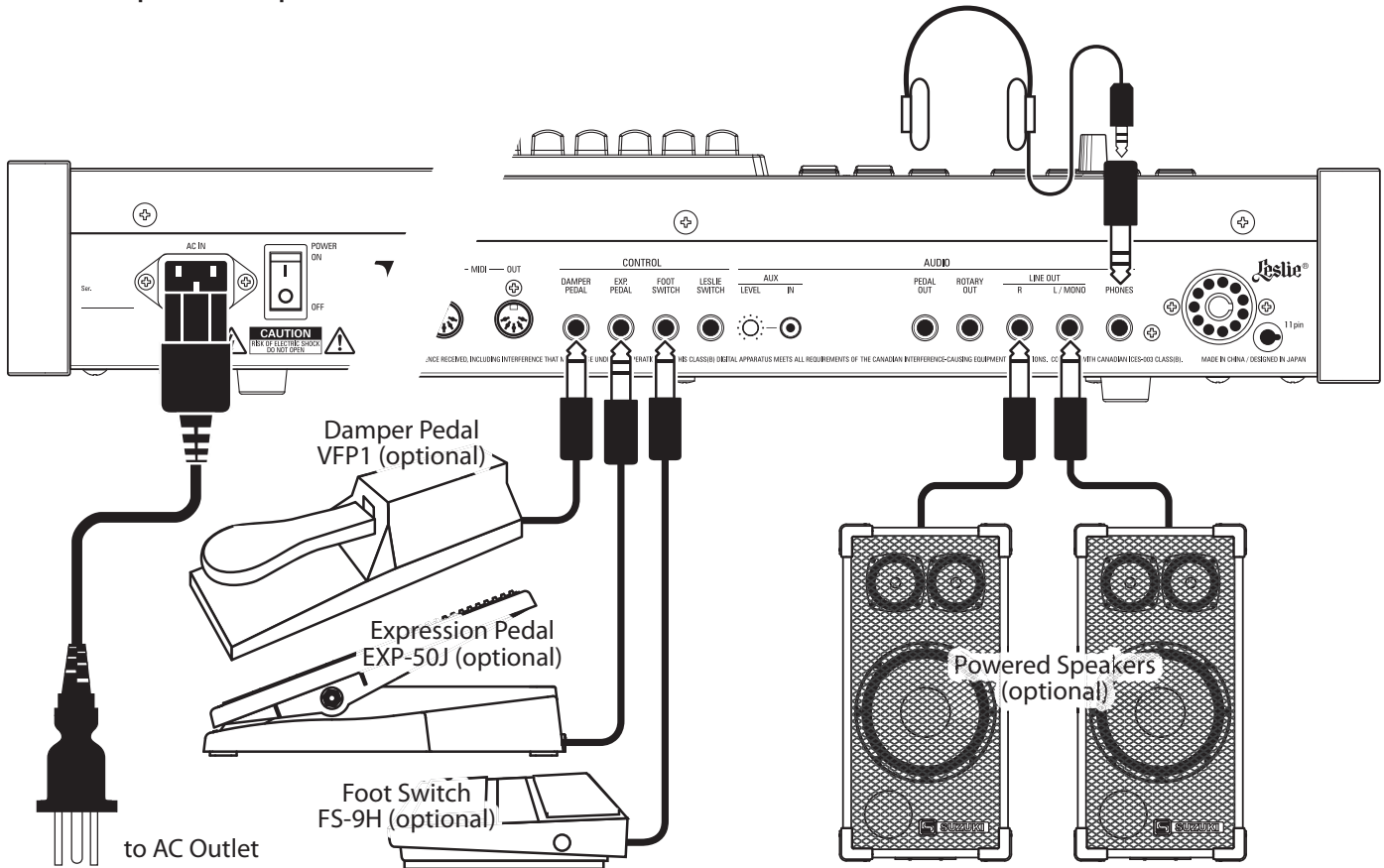

NOTE: The Expression Pedal, Foot Switch and Damper Pedal Parameters must be set properly. This is explained in more detail starting on page 108.

⚠ CAUTION

This instrument draws a slight amount of power even if the [POWER] switch is "OFF." Therefore, if the instrument will not be used for a long period of time, disconnect the AC plug from the outlet.

Do not place this instrument in direct sun light, near heat sources, or in a hot location.

A Leslie Speaker Cabinet with an 11-pin interface can be directly connected to the XK-4.

NOTE: Be sure the power to the XK-4 is "OFF" before connecting the Leslie Speaker.

Connecting a single-channel Leslie Speaker

Connecting a 3-channel Leslie Speaker

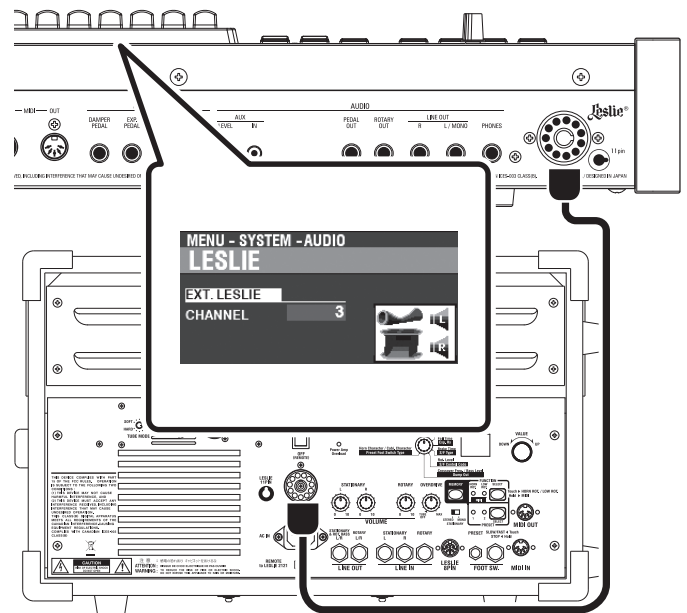
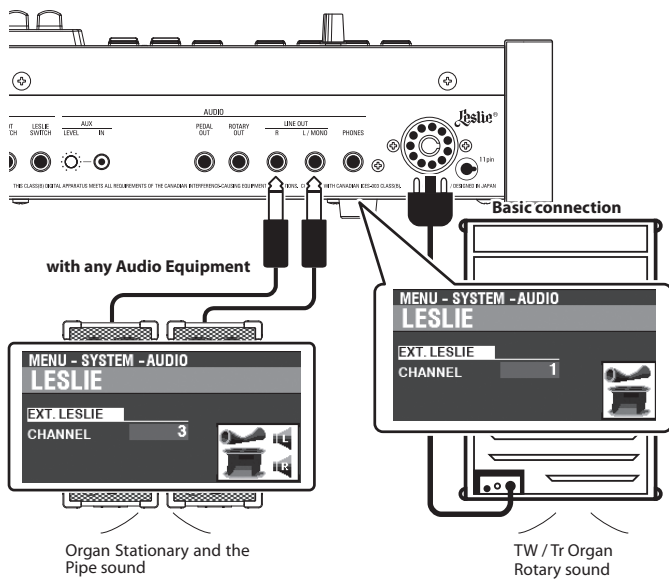

BASIC CONNECTIONS

SINGLE-CHANNEL TYPE (122XB, 122H, 981 or 3300/W)

USING ONLY A LESLIE SPEAKER SYSTEM

1. Connect the XK-4 to the Leslie Speaker via an 11-pin Leslie cable (optional LC-11-7M, not included).
2. Turn the power to the XK-4 "ON" and set the EXT. LESLIE CH (P. 107).
1 122XB, 981 or 330W
1,w/Pre 122H or 142H

USING ADDITIONAL AUDIO EQUIPMENT

1. Connect the XK-4 to the Leslie Speaker via an 11-pin Leslie cable (optional LC-11-7M, not included).
2. Connect the XK-4 to a keyboard amp or powered speakers via ¼" audio cables from the LINE OUT jacks of the XK-4.
3. Turn the power to the XK-4 "ON" and set the EXT. LESLIE CH Parameter at "3" (P. 107).
4. Make sure "TW" (Tone Wheel) Organ Type is selected (P. 37).
5. Press the [BYPASS] button "ON" and set the audio equipment at a desired level.
6. Press the [BYPASS] button "OFF" and set the Volume of the connected Leslie Speaker at the same audible level as when the [BYPASS] button is "OFF."

3-CHANNEL TYPE (2101/mk2)

1. Connect the XK-4 to the Leslie Speaker via an 11-pin Leslie cable (optional LC-11-7M, not included).
2. Turn the power to the XK-4 "ON" and set the EXT. LESLIE CH Parameter to "3" (P. 107).
3. Make sure "TW" (Tone Wheel) Organ Type is selected (P. 37).
4. Press the [BYPASS] button "ON" and set the [STATIONARY VOLUME] of the Leslie Speaker at a desired level.
5. Press the [BYPASS] button "OFF" while playing, and set the [ROTARY VOLUME] of the Leslie Speaker at the same audible level as the [STATIONARY] Channel.

tips LESLIE CHANNELS

A traditional single-channel Leslie Speaker, such as a 122XB, 122H, 981 or 3300/W is equipped with a Rotary Channel only. In order to hear other voices, such as Pipe Organ sounds, a separate amplifier/speaker system must be connected via the LINE OUT jack(s).

OUTPUTTING DRY ORGAN SOUNDS

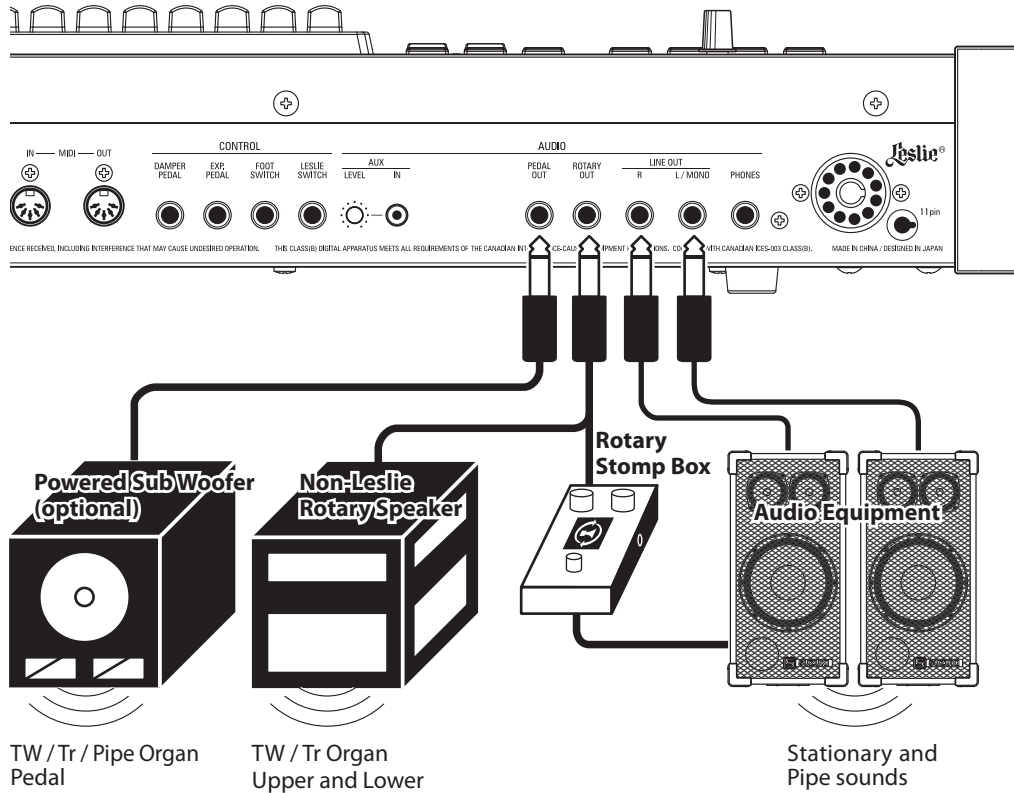

ROTARY OUT jack

Use the [ROTARY OUT] jack if you want to output a “dry” organ signal without the inbuilt digital Leslie.

NOTE: Set the “ROTARY OUT” switch in the AUDIO FUNCTION Mode at “Used” when using this jack to mute the ORGAN Section from the [LINE OUT] jacks. See page 107 for more details.

PEDAL OUT jack

This jack outputs the PEDAL Part.

Connect the [PEDAL OUT] jack to a powered sub-woofer if you want to reinforce the bass or bypass the Leslie to the PEDAL Part.

NOTE: Set the “PEDAL OUT” switch in the AUDIO FUNCTION Mode at “Used” when using this jack to mute the PEDAL Part from the [LINE OUT] jacks. See page 107 for more details.

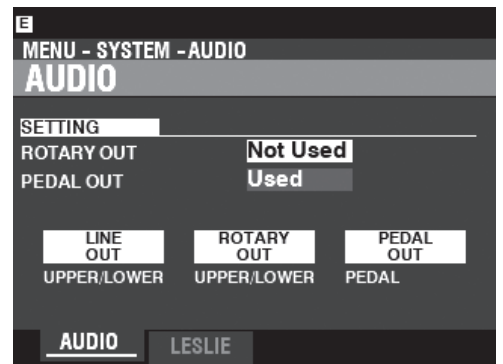

USING A MUSIC PLAYER

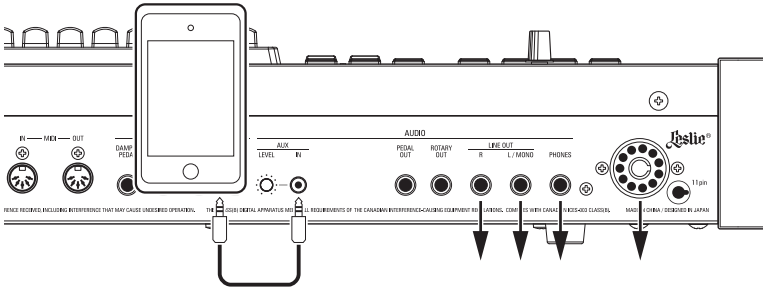

AUX IN jack

Use the [AUX IN] jack to connect a music player or phone.

Use the [AUX LEVEL] knob on the Accessory Panel to control the volume of a device connected via the [AUX IN] jack.

The audio signal via the [AUX IN] jack will combine with the output from the [LINE OUT] jacks, [PHONES] jack and/or the Stationary Channel of the 11-pin Leslie socket.

NOTE: The [MASTER VOLUME] knob does not affect the audio signal coming into the [AUX IN] jack.

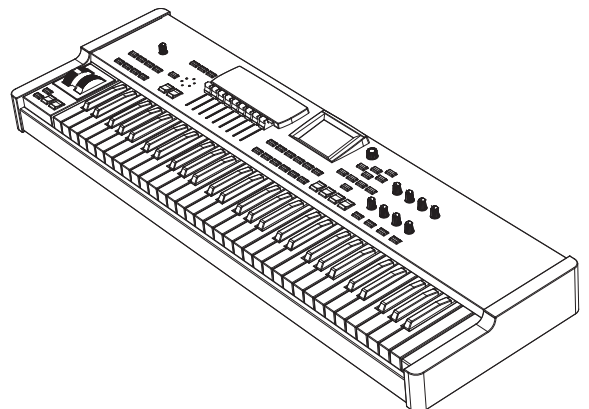

EXPANDING THE KEYBOARDS

The XK-4 can be expanded by connecting an external MIDI keyboard and/or a pedalboard.

DUAL MANUAL OPERATION

You can use the XK-4 and an external MIDI keyboard for UPPER and LOWER Keyboards without using SPLIT.

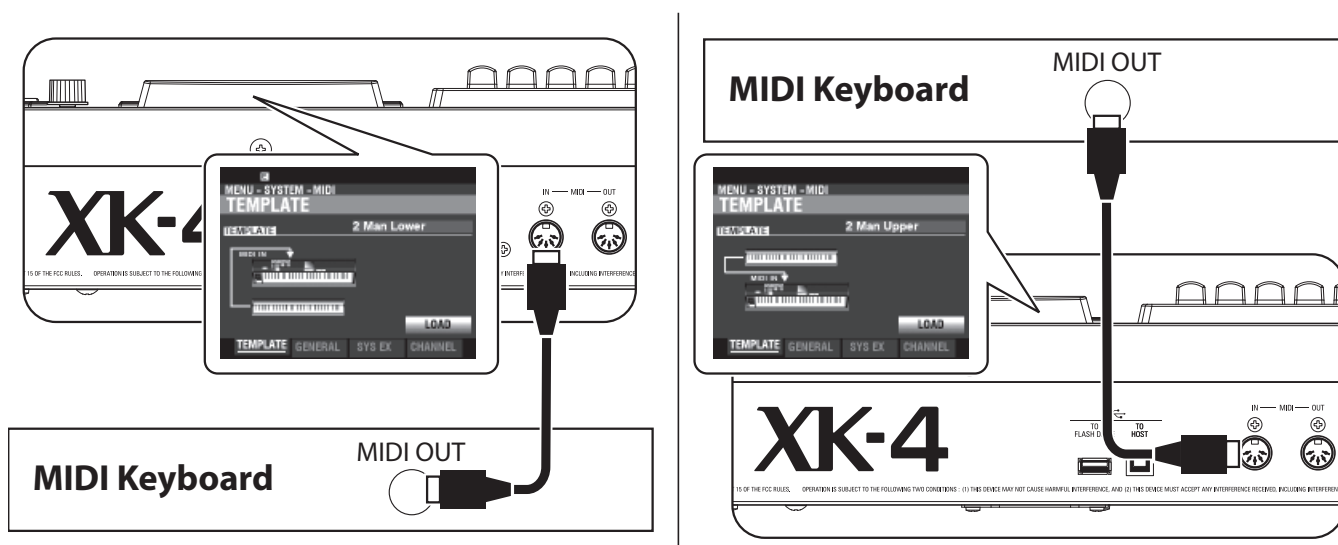

Follow the instructions below to connect an external MIDI keyboard to the XK-4.

NOTE: The above figures show MIDI connections only. For information on power supply or audio connections, see page 16.

You will also have to select a **MIDI Template** (P. 132), which is a preselected set of MIDI Parameters designed for specific MIDI applications.

To use an external MIDI keyboard with the XK-4, do the following:

1. Connect an external MIDI keyboard as shown above.
2. Turn the power to the XK-4 "ON" and press the MENU\EXIT button to enter MENU Mode.
3. Press the [PAGE ►] button two times to display the SYSTEM Menu.
4. Press the [DIRECTION ►] button once to select MIDI.
5. Press the [ENTER] button. You will see the MIDI TEMPLATE Page.
6. Use the [VALUE] knob to select the MIDI Template for the type of playing you want to do.
 - 2 Man Lower** The internal keyboard functions as the UPPER Keyboard and the connected MIDI keyboard functions as the LOWER Keyboard.
 - 2 Man Upper** The internal keyboard functions as the LOWER Keyboard and the connected MIDI keyboard functions as the UPPER Keyboard.

For more specific information about the connected MIDI keyboard, please refer to the Owner's Manual for the specific keyboard you are using.

TWO MANUALS + PEDALBOARD

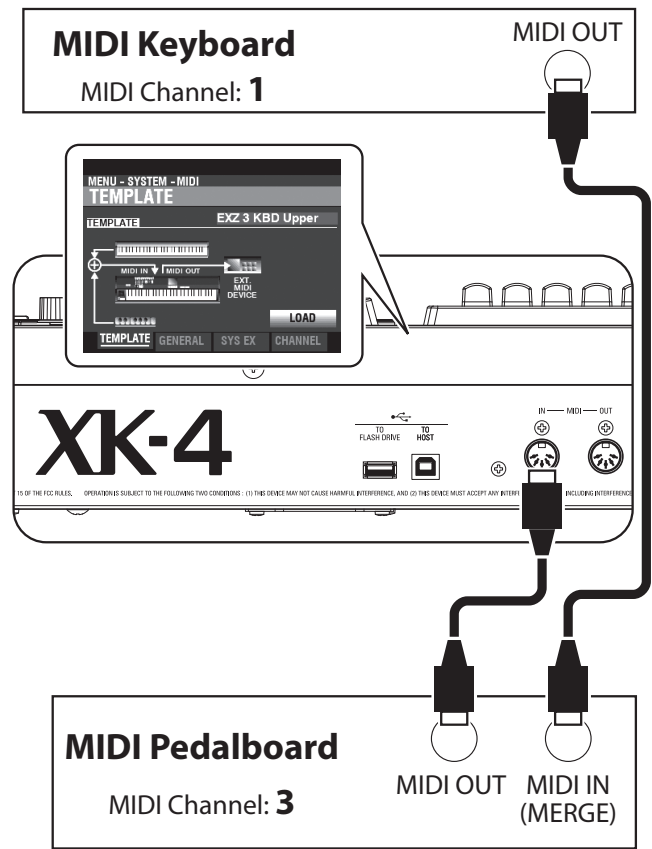
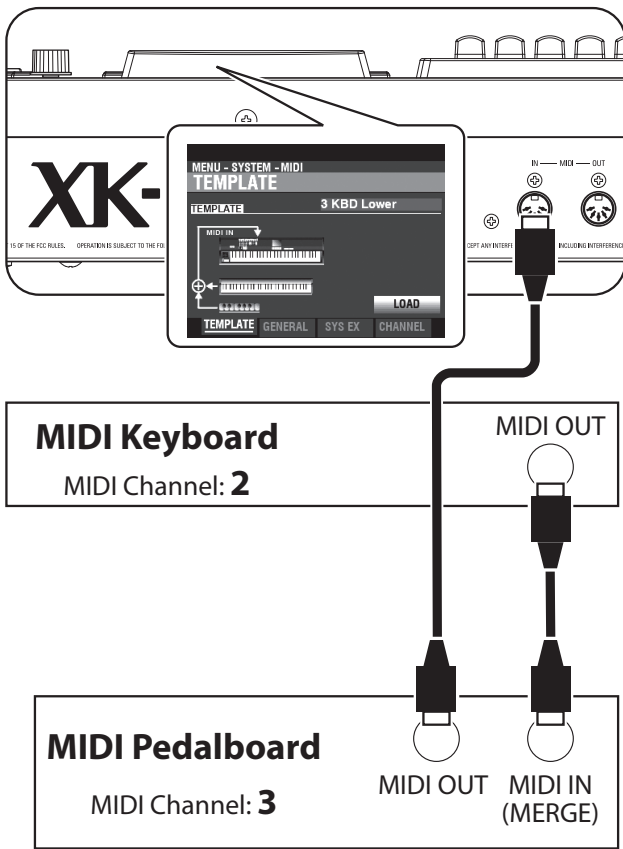

1. Connect as illustrated above. The XK-4 has one MIDI IN Port; therefore a MIDI keyboard with a merge function or a MIDI Merge-box is necessary for a dual keyboard configuration.

NOTE: The above figures shows MIDI connections only. For information on power supply or audio connections, see page 16.

2. Turn the power to the XK-4 “ON.”
3. Select MIDI Template (P. 132) “3KBD Upper” or “3KBD Lower.”
4. Set the Transmit channel of the added MIDI keyboard at “2” if you are using it as a LOWER Keyboard, or “1” if you are using it as a UPPER Keyboard. If you are using a MIDI Pedalboard, set its Transmit Channel at “3.”

NOTE: Hammond MIDI Pedalboards are automatically set to transmit on MIDI Channel 3.

RECOMMENDED MIDI PEDALBOARDS

The following HAMMOND MIDI Pedalboards are recommended for use with the XK-4:

- MIDI Sound Pedalboard XPK-130G (13 notes)
- MIDI Sound Pedalboard XPK-200G (20 notes)
- MIDI Sound Pedalboard XPK-200GL (long 20 notes)

NOTE: The XK-4 can also be used with the following Hammond MIDI Pedalboard models: XPK-100, XPK-200, XPK-200L.

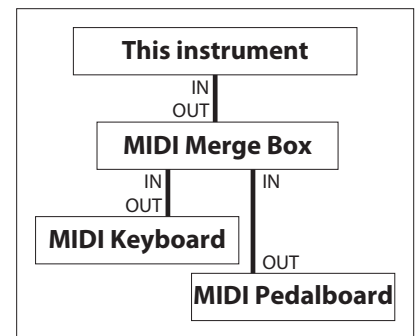

Using a MIDI Merge Box

CONNECTING THE CU-1 LESLIE SWITCH

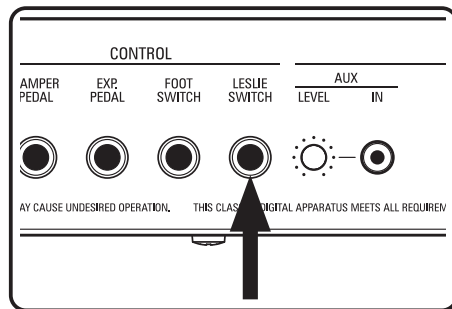
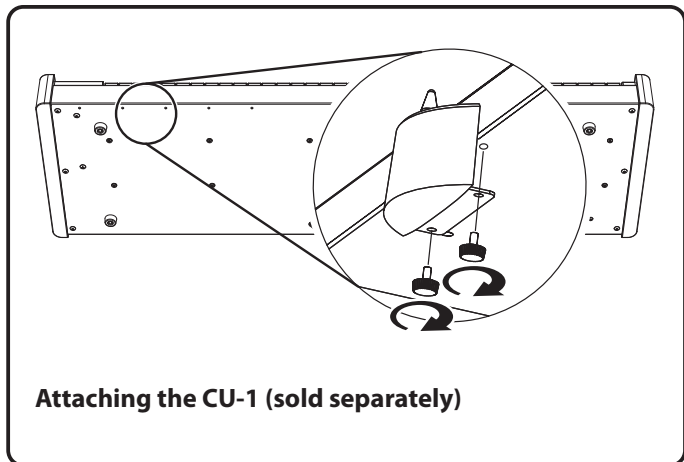

1. Insert the plug of the CU-1 Leslie Switch to the "LESLIE SWITCH" jack of this keyboard.
No parameter adjustments are necessary.

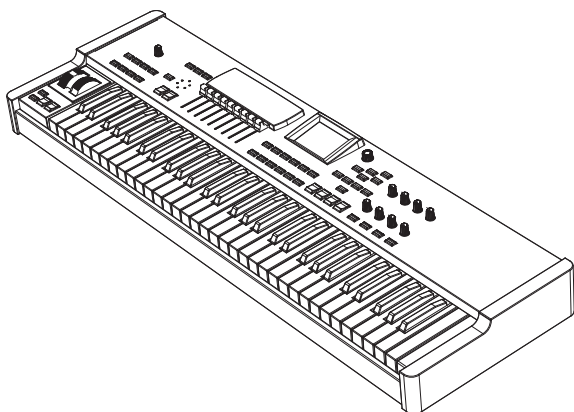



**TURN ON AND
PLAY**

HOW TO POWER ON

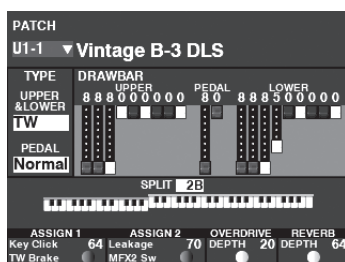
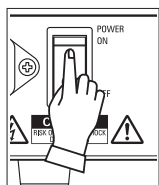
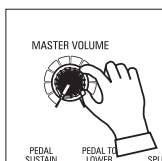

After making the connections described on the previous pages, you are ready to turn the XK-4 power “ON.” Follow the procedure below to prevent malfunction or damage.

OPERATION PROCEDURE

1. Before turning the power to the XK-4 “ON,” make sure you have connected all peripherals (Expression Pedal, Foot Switch(es), etc.) properly. Also be sure to set the [MASTER VOLUME] knob to its minimum setting.

NOTE: The polarity of each Foot Controller will be detected automatically.

2. The [POWER] switch is located on the right side of the Accessory Panel facing the keyboard. Turn the power to the instrument “ON.” The display will show, “Loading...” below the opening screen for approximately 20 seconds while the system software loads, then the PLAY Mode screen will display.

NOTE: If you have a Leslie Speaker connected to the instrument, the Leslie can be turned “ON” automatically.

3. Turn the power to the connected amplifier “ON.”
4. Hold down a playing key and turn the [MASTER VOLUME] clockwise slowly. Adjust the [MASTER VOLUME] as needed.

NOTE: If the [MANUAL] button is pressed in the Default setting and no Drawbars are pulled out, no sound will be heard. You can select any of the PATCH/FAVORITE [1] to [10] buttons to hear sounds.

5. Adjust the volume of the amplifier.

NOTE: To turn the XK-4 power “OFF,” reverse the above procedure. Also, be sure to turn the power to a connected amplifier “OFF” before turning the keyboard “OFF.” This will prevent a loud “pop” from the amplifier.

BACKING UP THE INITIAL SETTINGS

The XK-4 does not remember the status of the playing controls before the power is turned “OFF.” The status of the default settings is the same as when the PATCH [1] button is depressed.

AUTO POWER OFF

The XK-4 has an “AUTO POWER OFF” feature which will automatically turn the power to the instrument “OFF” if no keys or buttons are pressed for 30 minutes.

See page 115 “GLOBAL” for enable or disable the AUTO POWER OFF.

NOTE: Depending on the status of the instrument - while editing, for example - the power may not turn “OFF” even if AUTO POWER OFF is enabled. Therefore, it is best to turn the XK-4 power “OFF” via the [POWER] Switch after every use.

RESTORING THE FACTORY SETTINGS

To reset all Parameters of the XK-4 to their default settings, do the following:

1. Turn the power to the XK-4 “OFF.”
2. Press and Hold the red [RECORD] button.
3. While holding the red [RECORD] button, turn the [POWER] “ON.”
4. Continue to hold down the red [RECORD] button. When “Loading Default” is displayed, release the red [RECORD] button. The system will load.
5. When the PLAY Mode is displayed, the factory settings have been restored.

The illustration below shows the structure of the keyboards and memory.

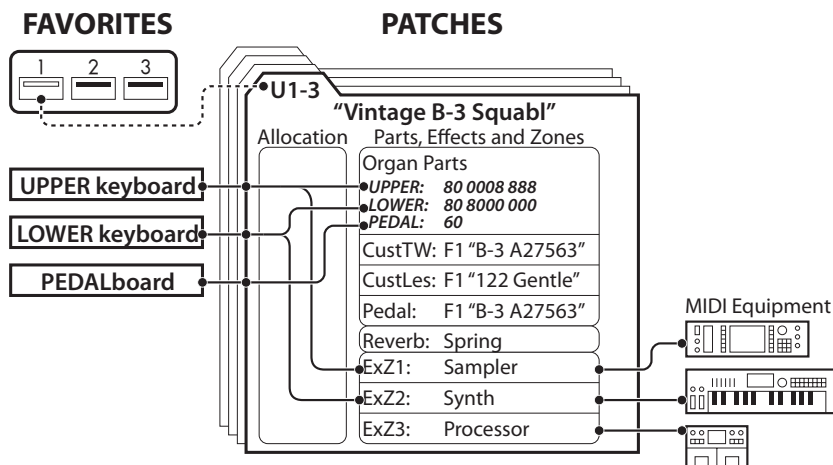

KEYBOARDS AND PARTS

KEYBOARDS

Split:



Expanded:

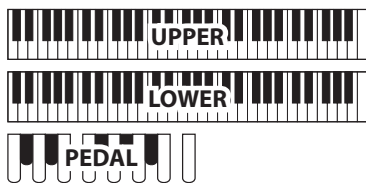

The Keyboards on this instrument can be allocated either by using the SPLIT feature (P. 48) to divide the keyboard or by expanding the instrument via MIDI (see the illustration above). When the [SPLIT] feature is enabled, the portion of the keyboard to the right of the SPLIT Point is called UPPER and the left portion of the keyboard is called LOWER. PEDAL refers to the bass tones which can be played from a connected MIDI Pedalboard.

PARTS

This instrument has 3 Parts - UPPER, LOWER and PEDAL to replicate the performance of a classic Hammond Organ with two manuals and pedals.

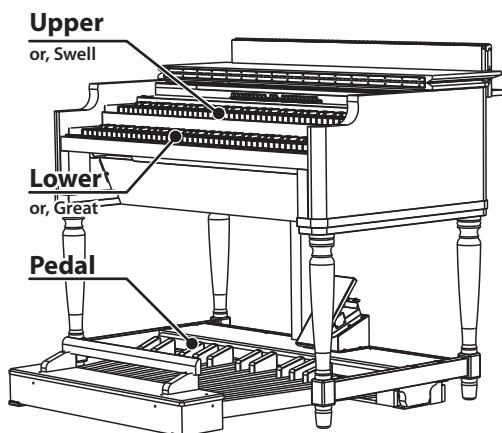

MEMORY

PATCHES

A **Patch** (P. 26) is the basic memory unit of this instrument. A Patch contains;

- ◆ Organ settings (Organ Type, Drawbar Registration...)
- ◆ Internal Zone (Split, Octave...)
- ◆ External Zones (MIDI Channel, Program...)
- ◆ Effects (Vibrato, Overdrive, Leslie...)

FACTORY AND USER

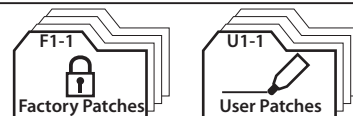

The Patches are grouped in two ways. “F” (Factory) Patches are set at the factory and cannot be changed. “U” (User) Patches can be changed by the player.

There are 100 Factory and 100 User Patches (P. 146).

On the factory shipped, all the User Patches has same contents as the Factory Patches.

FAVORITES

The **Favorite** (P. 116) feature allows you to store and recall frequently-used Patches (see illustration at the top of this page, upper-left side).

There are 10 [FAVORITE] buttons. In addition, there are 10 Banks of Favorites, bringing the total number of Favorites to 100. Use the [BANK] button to access the Favorite Banks.

USING PATCHES

Patches are the basic memory units of this instrument. This is explained in detail starting below.

WHAT IS A "PATCH"?

The various sounds and Parameter settings of this instrument are grouped into units called Patches. Patches are further gathered into groups called Banks.

The illustration below shows the structure of Banks and Patches as shown in the display.

Domain	Bank	-	Number
Factory	1		1
or	X	∩	X
User	10		10

NOTE: The User ("U") Patches are pre-programmed from the factory with the same settings as the Factory ("F") Patches.

SELECT A PATCH

USING THE [VALUE] KNOB

When the PLAY Mode is displaying, you can use the [VALUE] knob to Recall or preview the entire Patch library.

① LOCATE THE PLAY MODE

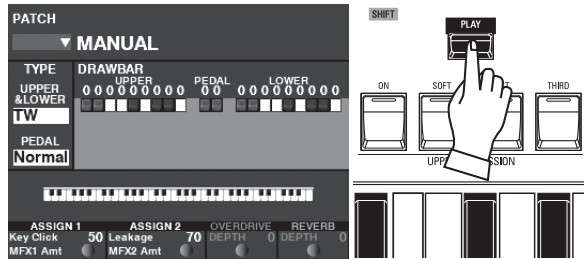

If the PLAY Mode is not displaying, press the [PLAY] button to display it.

② MOVE THE CURSOR TO THE PATCH NUMBER

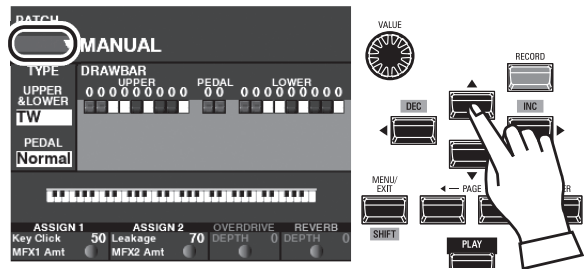

If the cursor is not at the Patch Number (very top of the screen), move the cursor to it using the DIRECTION buttons.

③ SELECT A PATCH

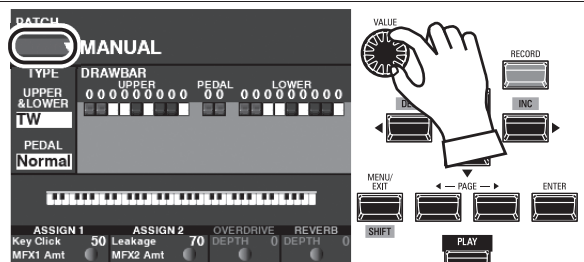

Use the [VALUE] knob to select a Patch.

USING THE NUMBER BUTTONS

This method can be used to recall User Patches U1-1 through U10-10.

NOTE: This method cannot be used to recall "F" or Factory Patches.

This method is also used for recall Favorites (P. 116)

For example, to Recall User Patch "U5-2" (Bank #5, Number #2), do the following:

① SELECT THE BANK

NOTE: If you are working in the currently selected Bank, you may skip this step.

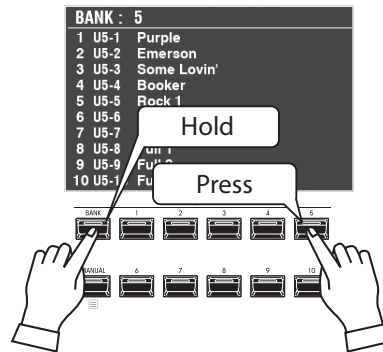

Press and Hold the [BANK] button, and press the NUMBER button of the Bank you want to Recall (5 in this example).

The display shows the Bank Number at the top and the list window of the Patches in the selected Bank.

The NUMBER buttons will flash, prompting you to select a Patch within the selected Bank.

② SELECT THE NUMBER

Press one of the NUMBER buttons. For this example, press the NUMBER "2" button.

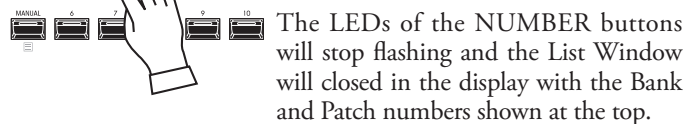

The LEDs of the NUMBER buttons will stop flashing and the List Window will closed in the display with the Bank and Patch numbers shown at the top.

tips "▼" INDICATES A LIST

An arrow ("▼") shown to the right of the items in the screen indicates a List Menu is available to select among multiple values or selections.

To open a List Menu, press the [ENTER] button with the cursor on the "▼" item. Use the [VALUE] knob or the [▲]/[▼] buttons to select the item you want, then press the [ENTER] button. The highlighted item will be selected and the List Window will closed.

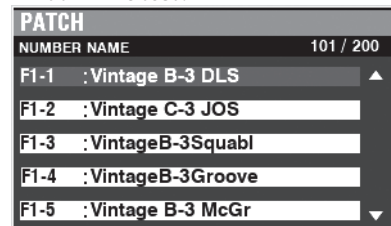

CHANGING THE INPUT METHOD

You can select a Patch with the NUMBER buttons using the “2-digit input” method. This eliminates the need to use the [BANK] button.

To do this:

① GO TO THE MENU

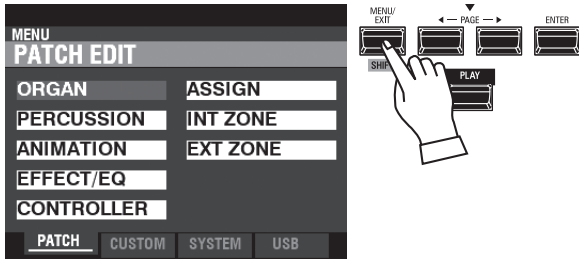

Press the [MENU/EXIT] button to go to the Menu mode.

② LOCATE THE SYSTEM PAGE

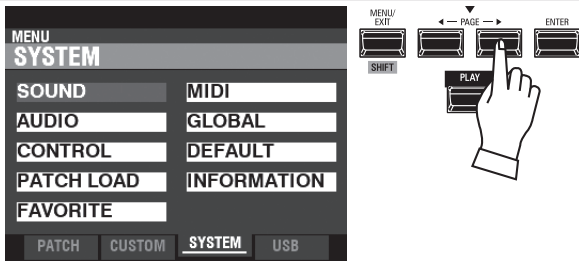

Use the PAGE [▶] button to locate the **SYSTEM** page.

③ SELECT THE PATCH

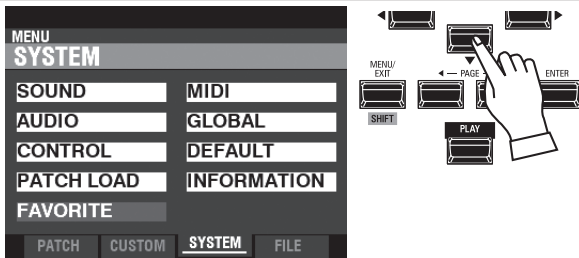

Use the DIRECTION [▼] button to select **FAVORITE**.

④ ENTER THE FAVORITE FUNCTION MODE

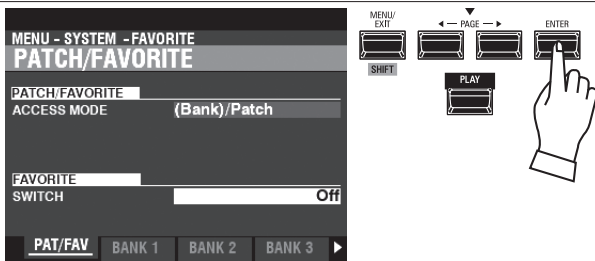

Press the [ENTER] button. You are in the FAVORITE FUNCTION MODE. The PATCH/FAVORITE Page should display.

⑤ CHANGE THE ACCESS MODE

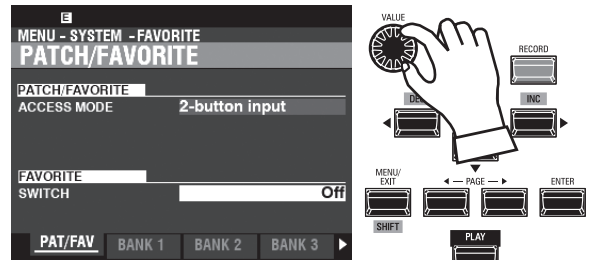

Use the DIRECTION buttons to highlight the box to the right of “ACCESS MODE” if it is not already highlighted.

Use the [VALUE] knob to select “2-button input”.

⑥ RECORD THE CHANGE

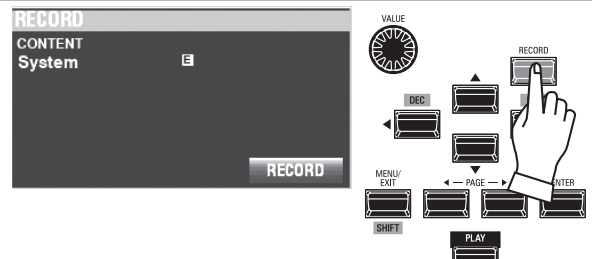

Press the [RECORD] button. The “RECORD” dialog box will appear.

Press the [ENTER] button to complete the operation.

NOTE: If you DO NOT wish to Record, press the [MENU/EXIT] or [PLAY] button instead of the [ENTER] button.

⑦ RETURN TO THE PLAY MODE

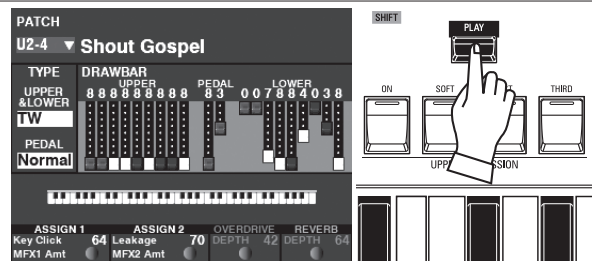

Press the [PLAY] button to return to the PLAY mode.

USING CONTROLLERS

The various Controllers of this instrument are explained in detail starting below.

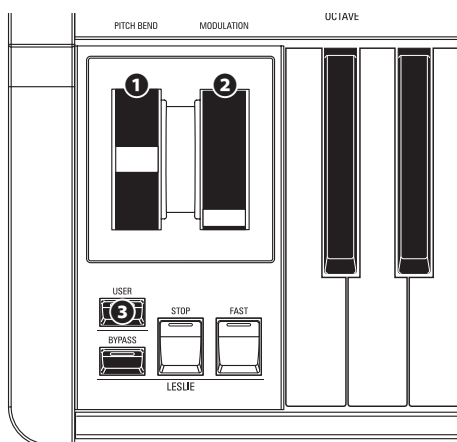

INTERNAL CONTROLLERS

1 PITCH BEND wheel

This allows you to bend the pitch “UP” or “DOWN” smoothly. Push the wheel away from you to bend the pitch “UP,” and pull it toward you to bend the pitch “DOWN.” When the wheel is released, it will automatically return to its center position (P. 86).

2 MODULATION wheel

This adds Vibrato or Modulation to the sound for external MIDI devices. Push the wheel away from you to increase the effect, and pull it toward you to decrease the effect.

NOTE: The Modulation Wheel is designed primarily for controlling effects on a connected MIDI device; however, it can be used to control certain internal effects on this instrument (P. 86).

3 USER button

This allows you to assign a function for instant access (P. 111).

EXPRESSION PEDAL

You can use an Expression Pedal to control the overall volume while playing.

Press forward with the front of your foot to increase the volume and back with your heel to decrease the volume.

NOTE: You can adjust the minimum volume of the Expression Pedal (P. 109).

FOOT SWITCH

You can use a Foot Switch to control various functions - for example, switching Leslie rotor speeds.

NOTE: You can assign a Foot Switch to control various functions (P. 108).

DAMPER PEDAL

You can use a Damper Pedal to hold or sustain notes while it is pressed and held, similar to the damper pedal on an acoustic piano.

NOTE: You can assign the Damper effect to any of the Parts (P. 86).

LESLIE SWITCH

The Leslie Switch switches the Slow, Stop and Fast the modes of the Leslie effect.

This switch is high durability, for players who switching frequently while playing.

NOTE: This explanation applies to a Leslie Mode Switch. Although there is also a “Leslie Main/Echo Switch” used to control the sounds from multiple Leslie cabinets, this instrument supports the Leslie Mode Switch only.

The generic term “Leslie Switch” refers to the Mode Switch in most cases.

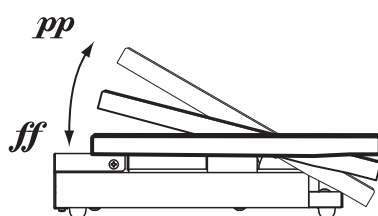

EXP-50J (optional)

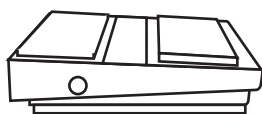

FS-9H (optional)

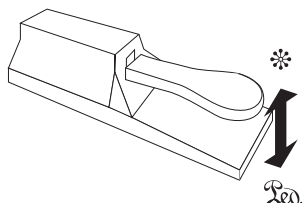

VFP1 (optional)

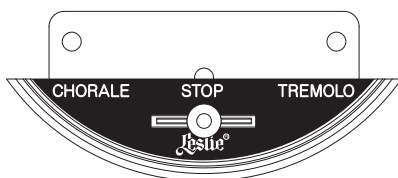

CU-1 (optional)

tips NAMES OF LESLIE MODES

The original Leslie “Vibratone” speaker had only one speed, called “Tremolo” or FAST Mode. Later model Leslie cabinets incorporated two speed modes, called “Chorale” and “Tremolo.” The original names are used on the CU-1 Leslie Switch, but in more recent times “SLOW” is more often used to describe the “Chorale” mode while “FAST” denotes the “Tremolo” mode.

The Master Equalizer allows you to tailor the sound during performance by boosting or cutting certain portions of the frequency spectrum.

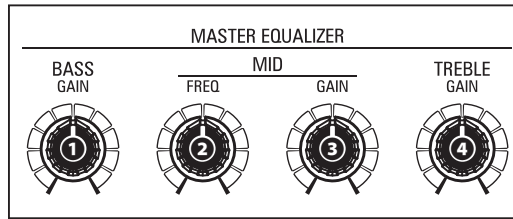

1 BASS

This allows you to adjust the Boost/Cut of the BASS.

The setting range is -9 to +9. In the center position the response is flat.

2 MID FREQUENCY

This allows you to adjust the center frequency (Middle) to be attenuated.

The setting range is 125Hz - 4.0kHz.

3 MID GAIN

This allows you to adjust the Boost/Cut of the MID range.

The setting range is -9 to +9. In the center position the response is flat.

4 TREBLE

This allows you to adjust the Boost/Cut of the TREBLE.

The setting range is -9 to +9. In the center position the response is flat.

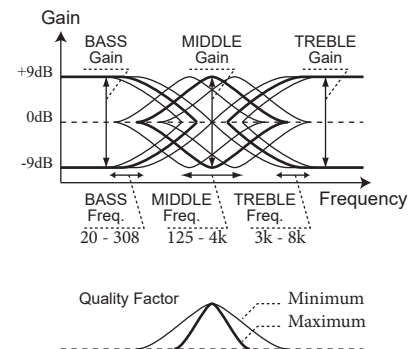

NOTE: The sound may distort if gains are raised too high. Adjust accordingly.

NOTE: The settings of these controls are not Recorded as Patch Parameters.

NOTE: You can adjust the corner or "turnover" frequency of the BASS and TREBLE and the "Q" (Quality factor) of the MID range). (P. 106)

CREATE YOUR OWN SETTING

This instrument can be registered for vintage Hammond Organ sounds, Combo Organs, and Pipe Organs.

This example shows you how to register this instrument for a classic “Jazz Organ” sound.

SELECT “MANUAL”

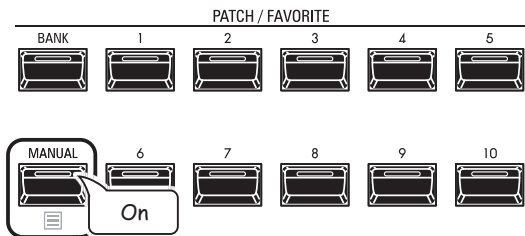

Press the [MANUAL] button “ON” (LED lit).

The [MANUAL] button makes all the current Control Panel settings active, allowing for real-time registration, and the creation of new Patches. The [MANUAL] feature is useful for creating new Patches from the “ground up,” or when making all registration changes manually - playing “on the fly,” in other words.

NOTE: To return to the Patch, press the [MANUAL] button again (LED off).

INITIALIZE “MANUAL”

Some Menu Parameters may not be set the way you wish even if [MANUAL] is selected. If you encounter this, you can initialize all the MANUAL Parameters using the following procedure.

① LOCATE THE PLAY MODE

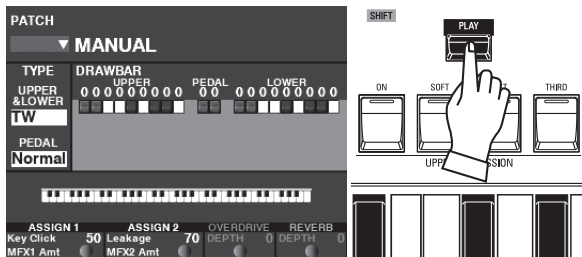

If the PLAY Mode is not displaying, press the [PLAY] button to display it.

② SELECT MANUAL

Press the [MANUAL] button “ON” (LED lit).

③ OPEN THE APP (APPLICATION) MENU

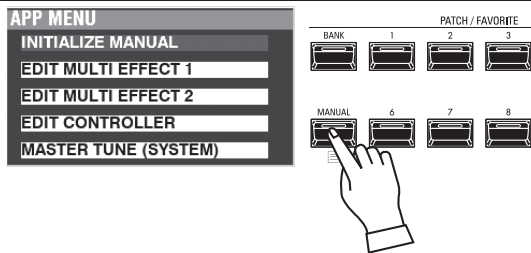

Press and Hold the [≡] button to open the APP Menu.

④ SELECT “INITIALIZE MANUAL”

If “INITIALIZE [MANUAL]” is not already highlighted, use the [▲][▼] buttons to select it, and press the [ENTER] button. The screen shown below will display.

⑤ COMPLETE THE PROCEDURE

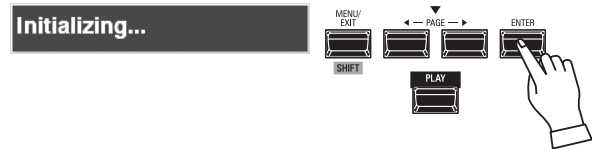

Use the DIRECTION [▼] button to move the cursor to the [INITIALIZE] icon, and press the [ENTER] button. The screen will display “Initializing...” for approximately 1 second.

NOTE: If you **DO NOT** wish to Initialize, press the [MENU/EXIT] or [PLAY] button instead of the [ENTER] button.

⑥ INITIAL STATUS

When [MANUAL] is Initialized, the following Parameters are set:

- Organ Type** TW
- Percussion** Off
- Vibrato & Chorus** Off, C-3
- Leslie** On, Slow
- Overdrive** Off
- Reverb** Off

tips RECORD MANUAL SETTINGS

The “MANUAL” settings will be lost if the instrument is turned “OFF.” However, you can Record the current “MANUAL” settings to be remembered when you next turn this instrument “ON.” (P. 52)

tips SWITCHING BETWEEN MANUAL AND PATCHES

When the [MANUAL] button is turned “OFF” after having previously been turned “ON,” the last-used Patch will be registered. In this way you can make a quick registration change by turning the [MANUAL] button “ON” and “OFF” while playing, giving you an effective total of 11 registrations you can access quickly - 10 numbered Patches plus [MANUAL].

tips “MANUAL”

The “MANUAL” feature cancels all Patches, internal Parameters, etc. It works much the same way as the “Adjust Presets” on Hammond Organs with Preset Keys or the “Cancel” piston on many classic organs or on electronic home organs such as the Hammond XT/XH-series. The Hammond 935 Church Organ has a feature called “Panel Memory” which performs much the same function.

SELECT A PART

DRAWBAR SELECT

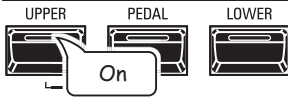

Use the DRAWBAR SELECT buttons to select which Part the Drawbars will control. If the LED of one of these buttons is lit, the Drawbars will control the sounds represented by that button.

For this example, press the [UPPER] button to turn it “ON” (LED lit) as shown in the illustration above.

PULL OUT THE DRAWBARS

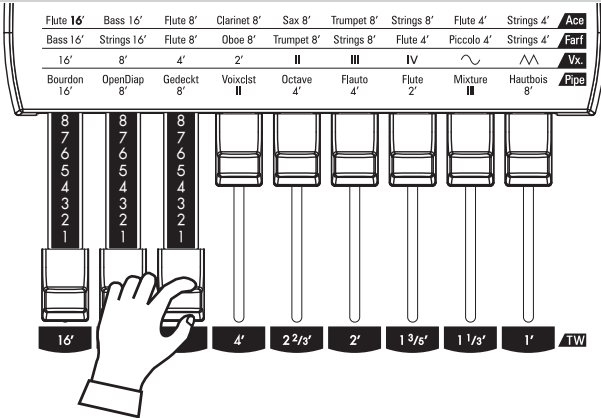

The Drawbars control the basic organ sounds. You can hear the effect each Drawbar has on the sound by pulling out or pushing in Drawbars while holding keys.

For this example, pull the first 3 Drawbars out all the way as shown in the illustration above.

ADD PERCUSSION



All the buttons are at “ON” (LEDs lit)

UPPER PERCUSSION

[PERCUSSION] here does not mean percussion instruments (drums, mallets, etc.) but the classic crisp attack unique to the Hammond Organ. It is commonly used to add an accent to Drawbar settings when desired.

For this example, press all four UPPER PERCUSSION buttons “ON” (LEDs lit).

ADD EFFECTS

VIBRATO & CHORUS

VIBRATO & CHORUS

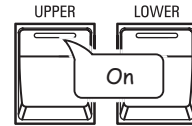
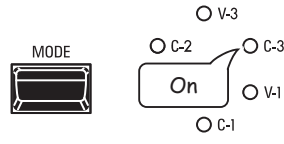

The Vibrato & Chorus adds richness and warmth to the sound by modulating the Drawbar tones.

For this example, use the [MODE] button to select “C-3” as the Mode and turn the UPPER button “ON” (LED lit).

LESLIE

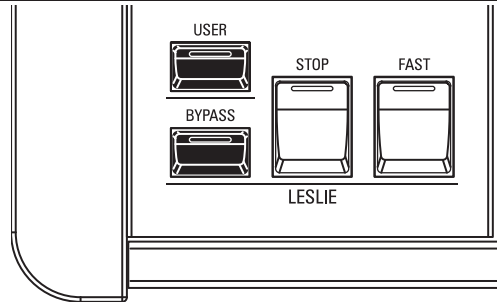

The Digital Leslie adds the classic “Leslie Tremolo and Chorale” effect to the sound.

For this example, make sure all the controls shown in the illustration above are “OFF” (no LEDs lit).

NOTE: As an alternate setting, press the [STOP] button “ON” (LED lit). This will stop the rotors from turning, creating an effect suitable for solos.

When you play this setting, you will hear the iconic “Jazz” organ sound.

RECORDING A PATCH

After you have created your own setting, you can save it as a User Patch (P. 26).

There are two ways to record a Patch.

- Using the [VALUE] knob,
- Using the Number buttons.

USING THE [VALUE] KNOB

① PRESS THE RED [RECORD] BUTTON

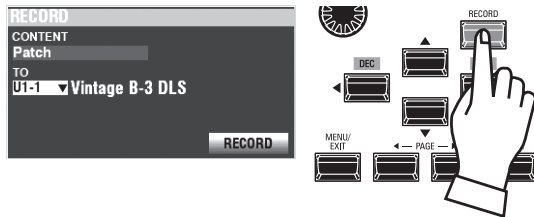

After you have made your changes to a Patch, press the [RECORD] button. The RECORD Page will display.

② SELECT THE ITEM TO RECORD (PATCH)

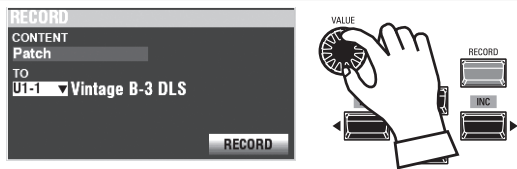

Use the [VALUE] knob and the DIRECTION buttons to set the CONTENT at "Patch," and the TO at the Patch number you wish to record.

Next, move the cursor on the [RECORD] icon, press the [ENTER] button.

USING THE NUMBER BUTTONS

This procedure is enabled when the FAVORITE Parameter is set to "Off" and ACCESS MODE is set to "(Bank)/Patch." (P. 116)

Example: Record "U5-3" (Bank #5, Number #3).

① SET THE BANK

NOTE: If you are working in the currently selected Bank, you may skip this step.

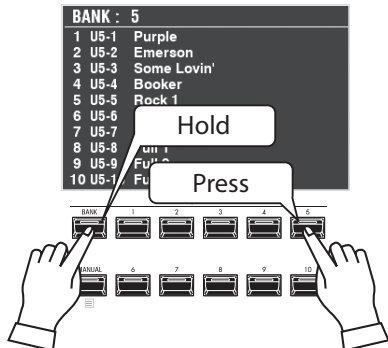

Press and Hold the [BANK] button, and Press and Hold the [BANK] button, and NUMBER button to select the Patch Bank ([5] in this example).

The display shows the list of the Patches in the Bank, and all the NUMBER buttons begins flashing for demand the selecting Number.

② SELECT THE NUMBER

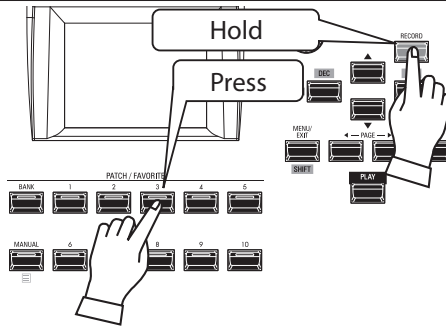

Press and Hold the [RECORD] button, and press any one of the NUMBER buttons ([3] in this example).

NAMING AND RECORDING

③ INPUT THE PATCH NAME

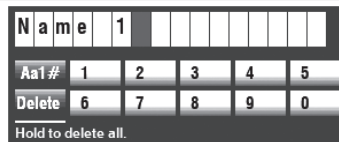

Input the Patch Name.

- [BANK] Change the character group.
- [MANUAL] Delete a letter.
- [1] - [10] Input a letter.
- DIRECTION [◀][▶] Move the cursor.
- [VALUE] knob Change the letter.

④ RECORD THE PATCH

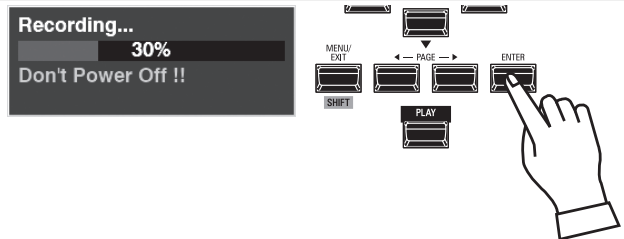

After you are finished Naming, press the [ENTER] button.

NOTE: If you DO NOT wish to Record, press the [MENU/EXIT] or [PLAY] button instead of the [ENTER] button.

The message shown above will display for approximately 1 second.

NOTE: Do not turn the power "OFF" while the above message is displaying.

When the display shows:

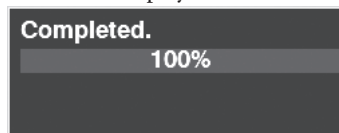

the Recording process is finished and your setting has been Recorded.



SETTING UP

SOUND ENGINE STRUCTURE

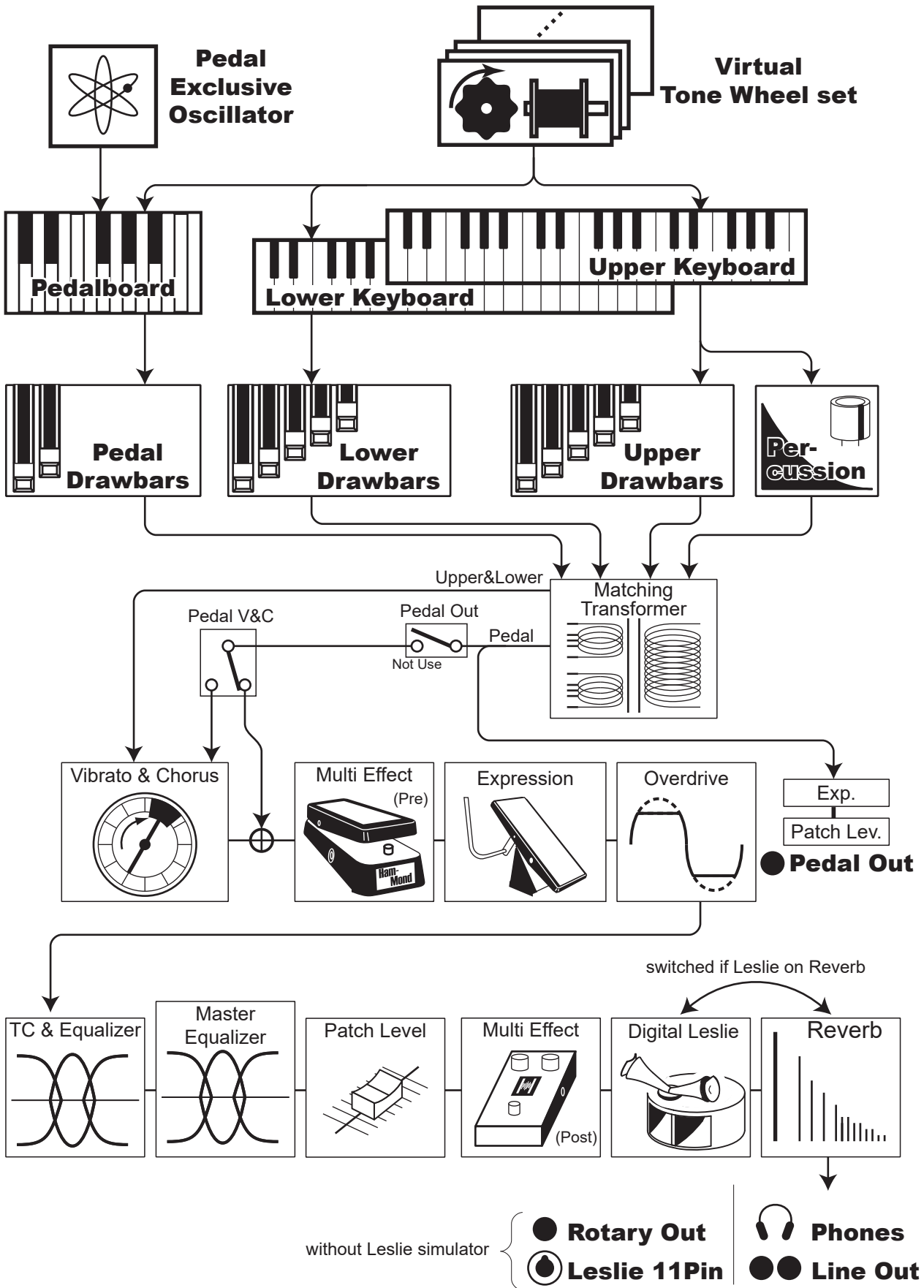

The Sound Engine Structure of this instrument is explained in more detail starting below.

◆ TONE WHEELS

The sound source or “engine” of the classic Hammond Organ is an electro-mechanical “Tone Wheel” generator. On this instrument, the Tone Wheel engine is replicated digitally.

While the power is on, each of the 96 virtual Tone Wheels keeps oscillating as they did in the vintage Hammond Organs.

◆ KEYS

The tone signals created with the 96 virtual Tone Wheels are “switched” at the keys.

To each key the signals corresponding to the pitch and harmonics (for example, 9 sets on the manual keyboard) are distributed, and when you touch or release a key, the switch connects or cuts the tone signals, in the same manner as a faucet controls water flow.

◆ DRAWBARS

Each Drawbar represents a fundamental harmonic. Each bar adjusts the volume of each harmonic. There are 9 drawbars corresponding to 9 different harmonics.

◆ TOUCH-RESPONSE PERCUSSION

The Percussion creates a distinctive attack on the UPPER part.

◆ MATCHING TRANSFORMER

The matching transformer matches the low impedance of the Tone Wheels and key circuits to the high impedance amplifier input. It serves also, through taps on its primary winding, to establish a series of intensity levels for the Drawbars.

◆ VIBRATO & CHORUS

The Vibrato & Chorus gives depth and richness to the organ sound by slightly varying the pitch (Vibrato), or doubling the voice by mixing the original sound, with a duplicate, slightly detuned one (Chorus).

◆ PRE AMPLIFIER, OVERDRIVE

Pre amplifier is the circuit for amplify the audio signal. But we can make it “overdrive” sound by excessive gain with deliberate.

◆ MULTI-EFFECTS

The Multi-Effects create various effects such as tremolo and Wah.

◆ EQUALIZER, LESLIE, REVERB

Other on-board Effects are as follows: an Equalizer for sculpting the tonal response, a Digital Leslie effect for rotary speaker effects, and Reverb.

(The on-board Leslie effect is disengaged when a external Leslie speaker is connected to the 11-pin terminal.)

◆ MASTER EQUALIZER

The Master Equalizer allowing you to tailor your sound for the provided venue, amp, sound system or recording. The settings are not saved in Patch memory.

tips 96 TONE WHEELS

On the B-3/C-3, there are 91 sounding tone wheels. Later Hammond models had 96 sounding Tone Wheels, with the 5 additional wheels used to extend the high frequency range.

tips PEDAL OSCILLATORS

This instrument includes a special group of PEDAL oscillators for reproducing the electronic PEDAL tones of Hammond Organs introduced after the B-3/C-3 series.

tips HARMONICS

A “harmonic” is a frequency which is an integer or whole-number multiple of the fundamental or “base” frequency. For example, if you start with the first white Drawbar then add the second white Drawbar, the first white Drawbar is the “fundamental” while the second white Drawbar is the “2nd harmonic.” The presence or absence of harmonics allows us to distinguish among different sounds - identifying the sound of a clarinet as distinct from the sound of a violin, for example.

tips PEDAL V&C

The pedal part can be “lifted” from the Vibrato and Chorus, and pre amplifier.

This is to get a clear bass sound as necessary.

ORGAN TYPES

The Drawbars on your XK-4 can be made to control organ sounds other than traditional Hammond Drawbars. Several makes of combo organs, for example, also used Drawbar-type controls to register the sounds, which were actual organ voices rather than individual harmonics as with Hammond Drawbars.

tone wheel (TW)

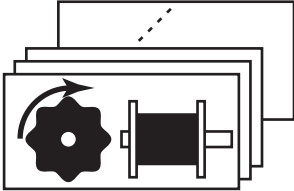

The Hammond Organ's original purpose was to duplicate the pipe organ, however, they became famous for producing a unique sound of their own.

Tone Wheel are the method by which Tone Wheel Hammond Organs generate sound. Each frequency is generated by a steel disk 1 7/8" in diameter and containing a number of high spots on its outer edge (see the illustration above.) These disks are the Tone Wheels. The most common Tone Wheel generator has a total of 96 tone wheels, all with different numbers of teeth - some wheels have 2 teeth, others have 4, 8, 16, 32, 64, 128, up to 192 teeth. The classic Tone Wheel design uses 91 tone wheels to generate the musical tones.

TRANSISTOR (Vx., Farf, Ace)

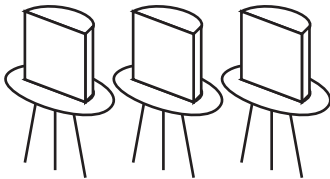

As transistors gradually replaced vacuum tubes in electronic circuits it became possible to produce light-weight combo organs. These have been used extensively in rock and popular music since the early 60's. The type of circuitry is different from maker to maker or model by model. We have replicated 3 representative types here.

Vx. replicates a British combo organ which combines triangle waves and square waves using several footages. "**Farf**" and "**Ace**" both replicate combo organs (Italian and Japanese) which use tablets to combine sound waves which are filtered to produce different tones.

PIPE

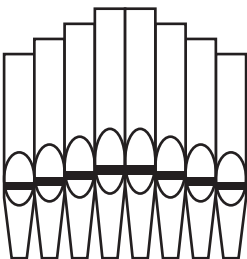

A pipe organ produces sounds by pushing pressurized air through sets of wood or metal pipes called Ranks or Stops. There are many different types of Pipe Stops which produce sounds of different pitches, timbres and levels of volume. Each Stop is identified by a unique Name indicating what type of sound it will produce when selected.

The **Pipe** Organ replicates several different types of pipe organs by using the Drawbars as drawstops or stop tablets to create pipe organ registrations.

tips CUSTOM TONE WHEELS - REPLICATING INDIVIDUAL TONE WHEEL ORGANS

You can duplicate the characteristics of virtually any Hammond Organ by using the **Custom Tone Wheel** feature to adjust various Parameters and Record them as Custom Tone Wheels.

This instrument contains several profiles of B-3/C-3 Tone Wheel organs as well as a **Mellow** setting which replicates the non-mechanical electronic Hammond Organs with Drawbars such as the X-5 combo organ, the Concorde and the later "multiplex" organs such as the B-3000 and 340 series Elegante.

tips PEDAL ORGAN TYPES

When using the Tone Wheel Organ for the UPPER & LOWER Parts, you can select two different PEDAL Voicings - **Normal** and **Muted**. **Normal** replicates the PEDAL Drawbars of a vintage Hammond Organ while **Muted** more nearly duplicates the mellow PEDAL Drawbar tones of an electronic Hammond.

On the Transistor Organs (**Vx.**, **Farf**, and **Ace**), the PEDAL Voicing is automatically set to **Muted**. For **Pipe**, the PEDAL Drawbars register Pipe organ voices to complement the UPPER and LOWER Pipe Voices.

SELECTING ORGAN TYPES

The Organ Type can be changed on the PLAY mode or DRAWBARS page in the FUNCTION mode.

This column explains how to change the Organ Types on the PLAY mode.

① LOCATE THE PLAY MODE

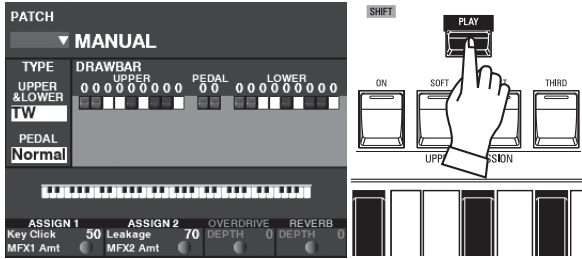

If the PLAY Mode is not displaying, press the [PLAY] button to display it.

② MOVE THE CURSOR

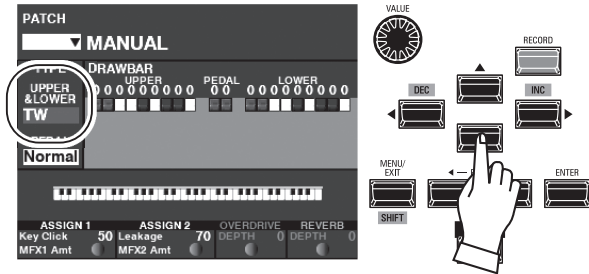

Use the DIRECTION [▲][▼] buttons to move the cursor to “UPPER & LOWER.”

NOTE: This example explains how to change the Organ Types for the (UPPER and LOWER) Parts. To select the Organ Type for the PEDAL part, move the cursor to “PEDAL.”

③ CHANGE THE VALUE

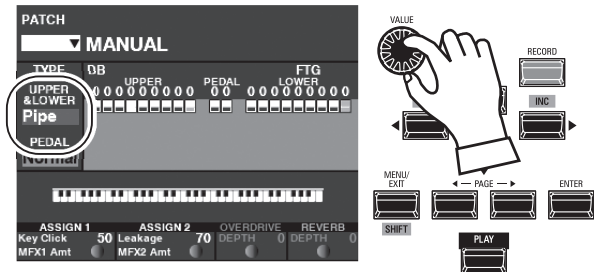

Use the [VALUE] knob to select the Organ Type you want.

HARMONIC DRAWBARS™

The Harmonic Drawbars are the heart of the renowned Hammond Sound and have been used since the first Hammond Organ Model A was introduced in 1935. There are approximately 253,000,000 possible sound combinations that can be produced by the Drawbars. The illustration below shows how each Drawbar relates to the keyboard when middle “C” is pressed.

DRAWBARS (TW: Tone Wheel)

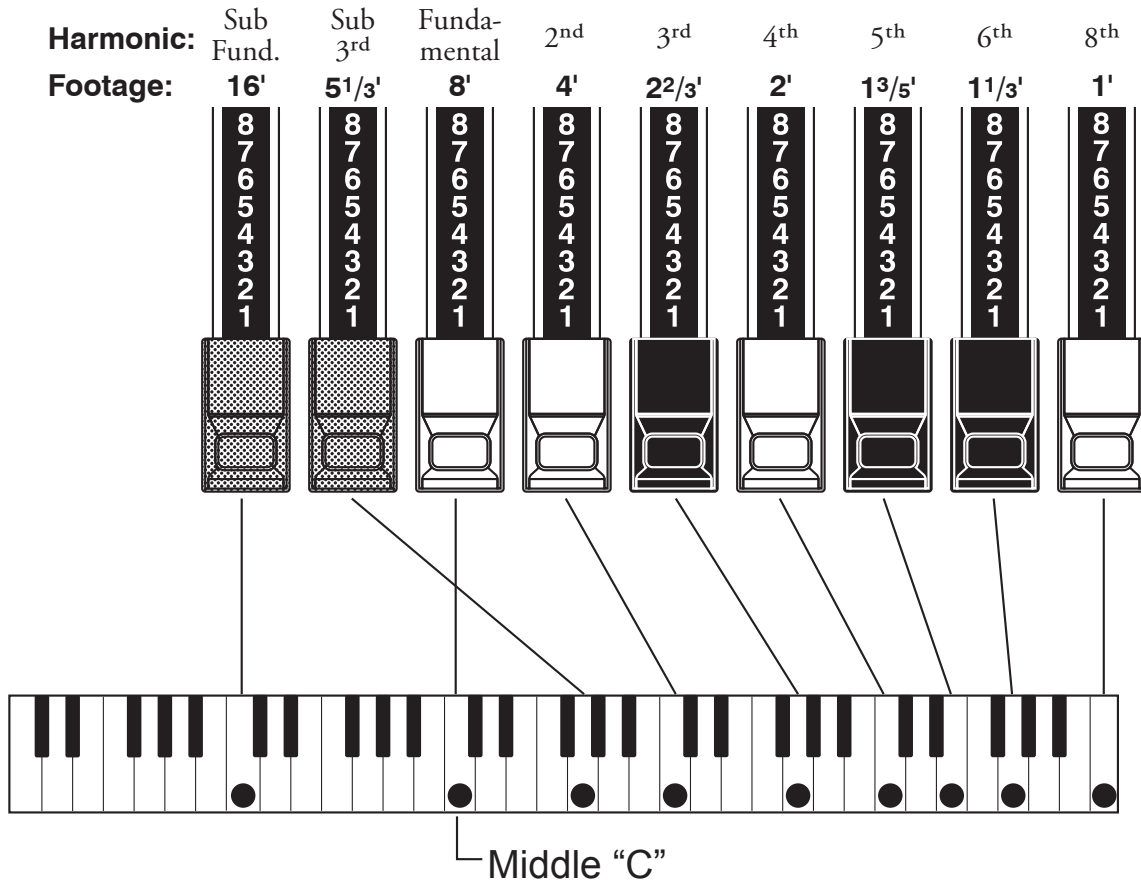

Each Drawbar may be set in eight different positions in addition to the silent or “0” position. Each position, as marked on the Drawbars, represents a different degree of intensity of the harmonic it controls. When drawn out to position “1,” the harmonic it represents will be present with minimum intensity, when drawn out to position 2 with greater intensity, and so on up to position “8.”

If you pull the fundamental (8’), the third harmonic (2 2/3’) plus the fifth harmonic (1 3/5’) Drawbars out completely and play the keyboard you will notice the sound resembles a clarinet.

If you push the 8’ Drawbar half-way, you’ll notice the sound becomes more high-pitched and a bit “harder.” Now pull the 8’ Drawbar back out fully and push the 2 2/3’ and 1 3/5’ in halfway. Notice how the sound becomes mellower.

Experiment with the Drawbars to obtain your own favorite registrations.

tips DRAWBAR REGISTRATION

Below is an example of using Drawbars to create different sounds.

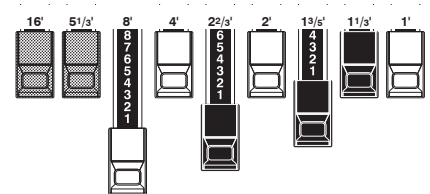

Example of “Clarinet”



For “Tone Wheel” Organs, the relationship between each Drawbar and its footage is shown on the “TW” legends directly in front of the Drawbars.

DRAWBARS FOR THE UPPER AND LOWER PARTS

The Colors of the Drawbars are traditional to Hammond, and were established to provide a quick visual guide to the harmonics generated by the Drawbars.

WHITE DRAWBARS

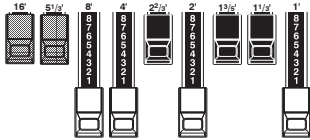

The first white Drawbar represents the “fundamental” or “8’ base” tone. All of the other white Drawbars are octave intervals or harmonics of the fundamental tone. The tonal brilliance is greatly increased by adding white Drawbars, but the harmonics added are always in “consonance” or harmony.

BLACK DRAWBARS

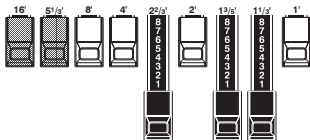

The black Drawbars represent the “dissonant” harmonics which are also necessary in building rich tone colors. The mellowness of a horn, the pungency of strings, and the brilliance of reed voices owe much of their character to the presence of these harmonics in different degrees.

BROWN DRAWBARS

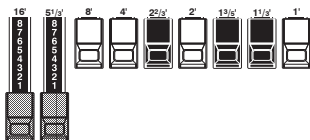

The two brown Drawbars on the far left give depth and richness to the sound. The left 16’ is one octave lower than the 8’, and 5 1/2’ is the third harmonic of the 16’ fundamental. Normally, the tones are built on the 8’ fundamental, but, if you want to add depth to the tone or to expand the playing range by one octave lower, build your tones on the 16’ fundamental.

PEDAL DRAWBARS

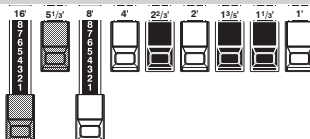

The 16’ and 8’ Drawbars control the sounds produced by the PEDAL part. The first brown Drawbar produces a composite tone at 16’ pitch for a deep foundation bass, while the first white Drawbar produces a composite tone at 8’ pitch, or one octave higher.

MATCHING THE REGISTRATION TO THE DRAWBAR SETTING

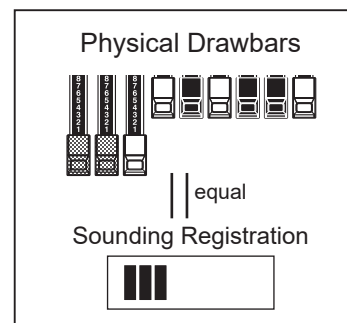
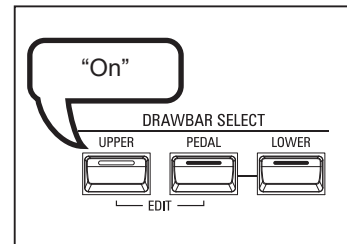
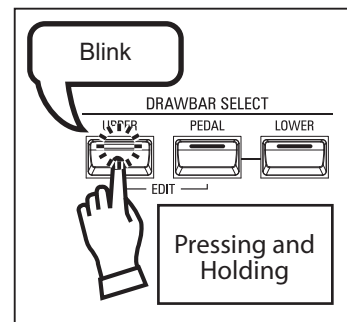
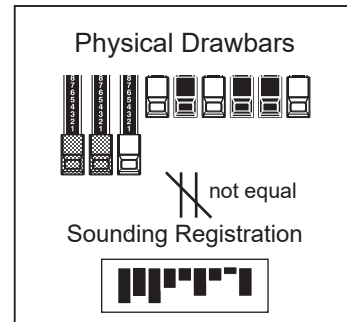

When you recall a Patch, the Drawbar registration of the Recorded Patch is heard, instead of the physical Drawbar setting. If you move any Drawbar, its position takes precedence over the Recorded registration, although the Patch is not changed.

If you want to switch to the physical Drawbar setting immediately, Press and Hold any of the three DRAWBAR SELECT buttons ([UPPER] [PEDAL] or [LOWER]) until the button LED blinks then release it. The physical registration now becomes “current” for the selected Part.

DRAWBAR REGISTRATION PATTERNS

Regardless of the size of a pipe organ or its number of stops, all of its voices are related to four basic families of tone. The four basic families - Flute, Reed, String and Diapason - can be quickly set up on the Drawbars by relating a pattern or shape to each family.

Flute family (2 step pattern)

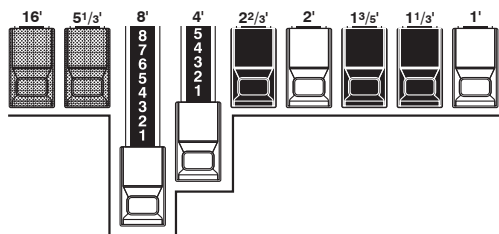

Accompaniment Flute 8' I.....	00 8460 000
Accompaniment Flute 8' II.....	00 3220 000
Accompaniment Flute 8' III.....	00 8600 000
Chorus of Flutes 16'	80 8605 002
Orchestral Flute 8'	00 3831 000
Piccolo 2'	00 0006 003
Stopped Flute 8'.....	00 5020 000
Tibia 8'	00 7030 000
Tibia 4'	00 0700 030
Tibia (Theater) 16'	80 8605 004
Wooden Open Flute 8'	00 8840 000

Diapason family (check mark pattern)

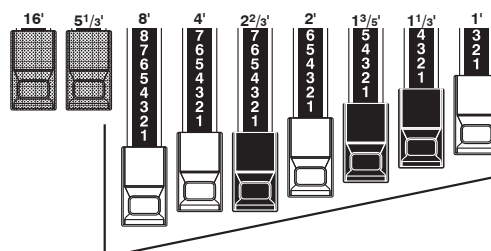

Accomp. Diapason 8'	00 8874 210
Chorus Diapason 8'	00 8686 310
Diapason 8'.....	00 7785 321
Echo Diapason 8'.....	00 4434 210
Harmonic Diapason 16'	85 8524 100
Harmonic Diapason 8'	00 8877 760
Harmonic Diapason 4'	00 0606 045
Horn Diapason 8'	00 8887 480
Open Diapason 8'	01 8866 430
Solo Diapason	01 8855 331
Wood Diapason 8'	00 7754 321

Reed family (triangle pattern)

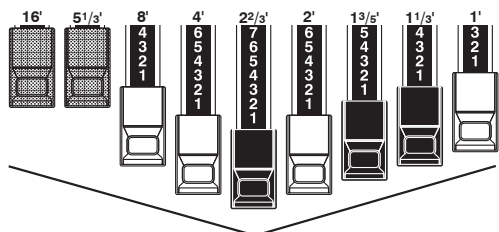

Bassoon 16'	44 7000 000
Clarinet 8'	00 6070 540
English Horn 8'	00 3682 210
Flugel Horn 8'	00 5777 530
French Horn.....	00 7654 321
Kinura 8'.....	00 0172 786
Oboe 8'	00 4764 210
Trombone 8'	01 8777 530
Trumpet 8'	00 6788 650
Tuba Sonora 8'	02 7788 640
Vox Humana 8'	00 4720 123

String family (bow pattern)

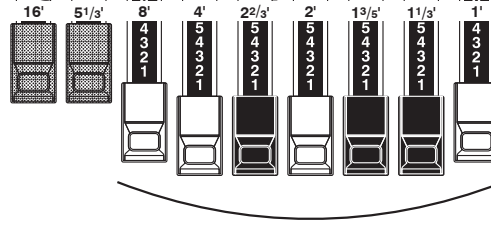

Cello 8'	00 3564 534
Dulciana 8'	00 7770 000
Gamba 8' I.....	00 3484 443
Gemshorn 8'	00 4741 321
Orchestral String 8'	00 1464 321
Salicional 8'.....	00 2453 321
Solo Viola 8'	00 2474 341
Solo Violin 8'	00 3654 324
Viola da Gamba 8'	00 2465 432
Violina 4'	00 0103 064
Violone 16'	26 3431 000

Notice that Drawbar registrations are expressed in number groups of 2, 4 and 3. This "2-4-3" number formula for Drawbar Registration has been a Hammond convention since the beginning. It has been found to be the easiest way to convey a specific setting.

The first two numbers correspond to the two brown Drawbars of either manual. The middle four numbers designate the 8', 4', 2 2/3', 2' Drawbars, and the remaining three numbers refer to the last three Drawbars.

MODERN DRAWBAR REGISTRATIONS

The Drawbar registration patterns shown on the previous page are intended to simulate the four basic families of tone found on a classical pipe organ, since this was the original intention of the Hammond Organ. Later on, as the Hammond Organ began to be used in Jazz, Pop and Rock music, other sounds became identified with the “Hammond Sound.” The figures below illustrate some of these modern registrations.

Jazz

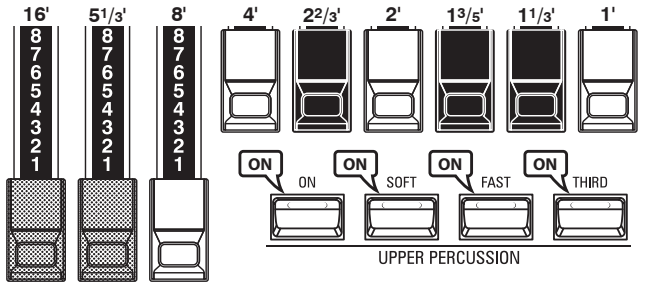

Bluesy

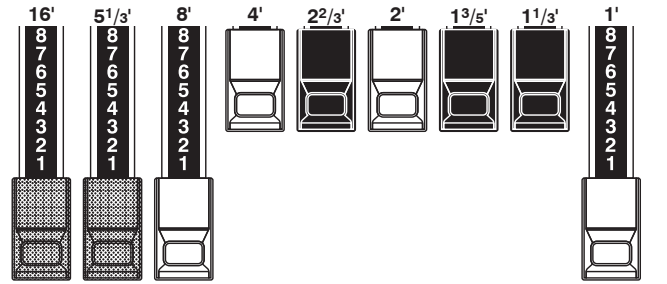

Groovy & Funky

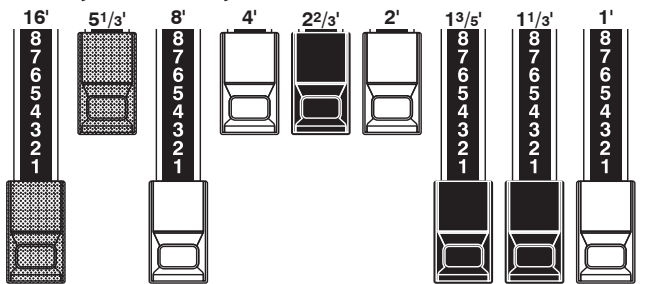

Max Power

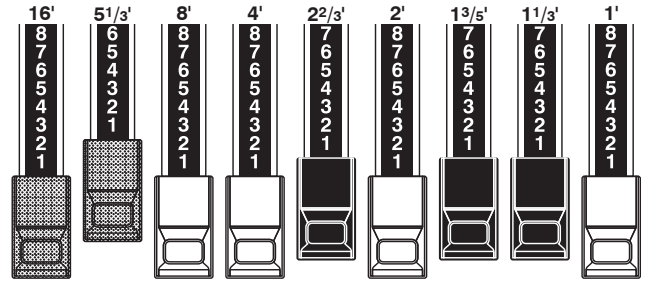

SQUABBLE (“Erroll Garner” Registration)

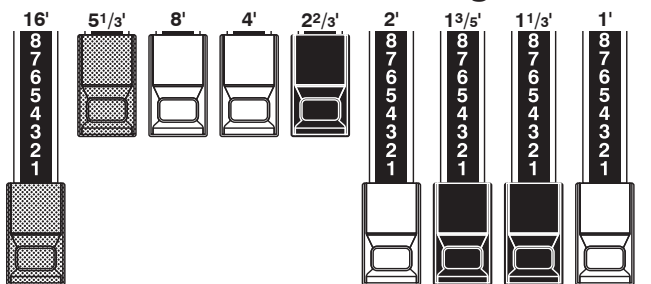

tips APPLICATION OF PERCUSSION

When Percussion is used, the sound of the 1' Drawbar is cancelled just as it is on vintage organs (B-3, C-3, A-100, M-3, etc.). Some jazz organists have taken advantage of this idiosyncrasy by keeping the 1' Drawbar pulled out and turning Percussion “ON” and “OFF” while playing. The result is an instantaneous registration change with a single motion.

DRAWBARS (Vx)

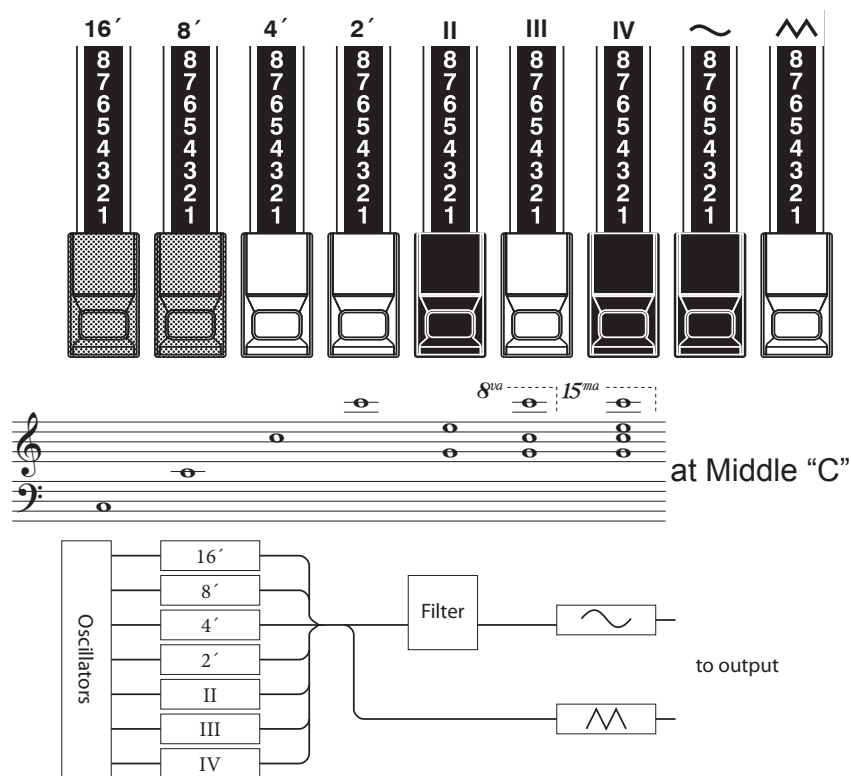

The type of British combo organ replicated by the “Vx” ORGAN Type had Drawbar-type controls, but they functioned differently from Hammond Harmonic Drawbars. The first four Drawbars control individual pitches, while the next three are “Mixture” Drawbars which cause multiple pitches to sound. “II,” “III” and “IV” refer to the number of pitches represented by that Drawbar.

The last two Drawbars control the type of tone produced by the first seven Drawbars.

The “~” Drawbar causes mellow tones to sound while the “M” Drawbar causes brighter and more harmonically complex tones to sound.

NOTE: The first seven Drawbars WILL NOT sound unless one or both of the right two Drawbars are also “out.” These two Drawbars regulate the overall volume as well as timbre of the total Drawbar registration, and can be used separately or together.

tips FOOTAGE

“Footage” is a term inherited from the pipe organ. It is used to designate the pitch at which a particular organ stop will sound. The number refers to the length of pipe necessary to produce the lowest note of that particular stop. For example, if a stop is marked “8” it means that the lowest note on a standard 5-octave organ keyboard “C” will require a pipe 8 feet long.

Flute 16'	Bass 16'	Flute 8'	Clarinet 8'	Sax 8'	Trumpet 8'	Strings 8'	Flute 4'	Strings 4'	Ace
Bass 16'	Strings 16'	Flute 8'	Oboe 8'	Trumpet 8'	Strings 8'	Flute 4'	Piccolo 4'	Strings 4'	Farf
16'	8'	4'	2'	II	III	IV	~	M	Vx
Bourdon 16'	OpenDiap 8'	Gedeckt 8'	VoixClst II	Octave 4'	Flauto 4'	Flute 2'	Mixture III	Hautbois 8'	Pipe

When using the “Vx” ORGAN Type, refer to the “Vx” row above the Drawbars for the correspondence between each Drawbar and the voice, footage and timbre.

tips FOOTAGE INDICATOR

The last manipulated Drawbar will be shown in the “Drawbar Registration” dialog box or the PLAY Mode for the ORGAN Section.

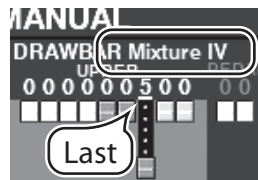

tips DRAWBAR COLORS

For the “Vx,” “Farf,” “Ace” and “Pipe” Organ Types, the Drawbar icons in the display will change color according to the sound registered for each Drawbar.

DRAWBARS (Farf, Ace)

Farf

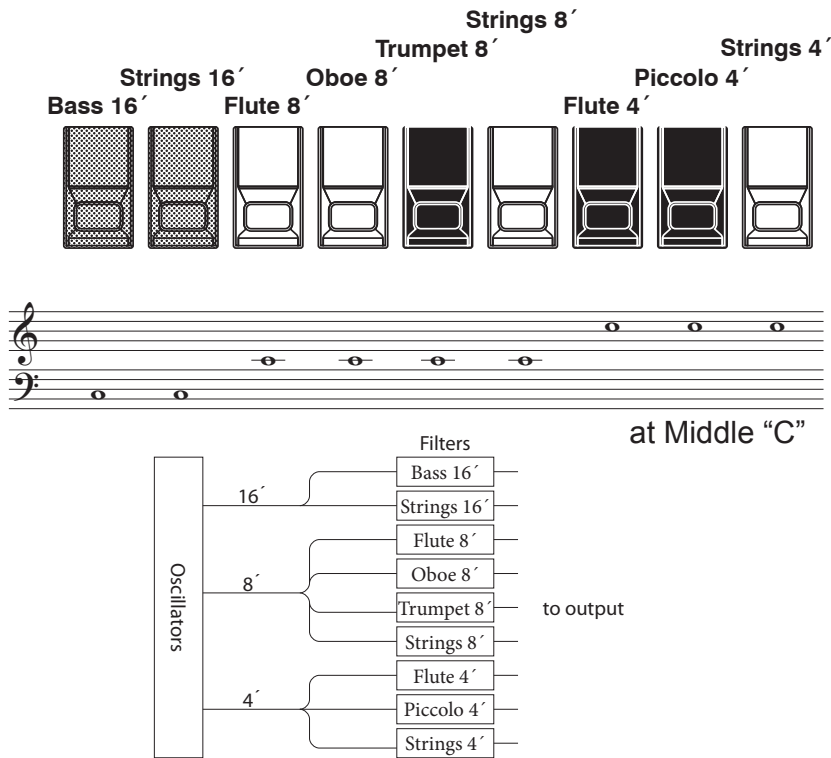

The figures to the left follow the layout of the Italian “Combo Compact” and the Japanese “TOP 7” combo organs, which used rocker-type tilt tablets rather than Drawbars to turn voices “ON” and “OFF.” On the XK-4, the Drawbars are used to control the same sounds.

To replicate the effect of tablets, simply pull the Drawbar(s) representing the tone(s) you want “out” all the way. Or, you can create shadings of tones by using the Drawbars in the more traditional fashion.

tips TABLET

The word “tablet” refers to a tilting or “rocker”-type control used on many analog organs to turn voices “ON” and “OFF” as well as to add effects (see figure below).



Ace

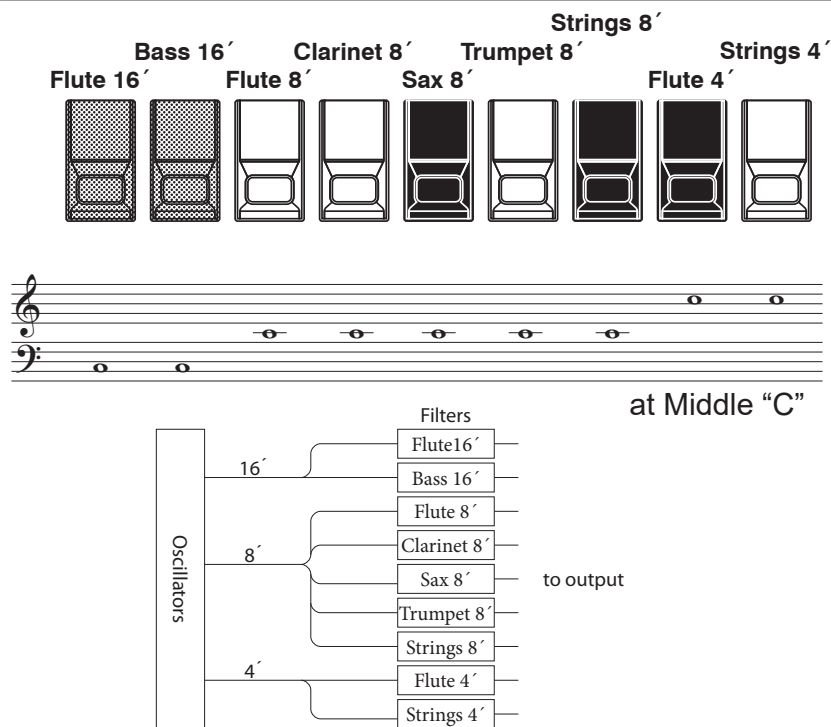

Flute 16'	Bass 16'	Flute 8'	Clarinet 8'	Sax 8'	Trumpet 8'	Strings 8'	Flute 4'	Strings 4'	Ace
Bass 16'	Strings 16'	Flute 8'	Oboe 8'	Trumpet 8'	Strings 8'	Flute 4'	Piccolo 4'	Strings 4'	Farf
16'	8'	4'	2'	II	III	IV	~	^	Vx.
Bourdon 16'	OpenDiap 8'	Gedeckt 8'	VoixCist II	Octave 4'	Flauto 4'	Flute 2'	Mixture III	Hautbois 8'	Pipe

When using the “Farf” or “Ace” ORGAN Types, refer to the “Farf” or “Ace” row above the Drawbars for the correspondence between each Drawbar and the voice and footage.

DRAWBARS (Pipe)

F1: Classic 1

UPPER: Bourdon 16' Open Diapason 8' Gedeckt 8' Viole Celeste II Octave 4' Flauto Dolce 4' Flute 2' Mixture III Hautbois 8'

LOWER: Principal 16' Principal 8' Melodia 8' Rohr Flute 8' Prestant 4' Flute 4' Super Octave 2' Mixture IV Trompette 8'

PEDAL: Sub Bass 16' + Gedeckt 8' Diapason 8' + Flute 4'

F2: Classic 2

UPPER: Prestant 8' Rohr Flute 8' Voix Celeste II Prestant 4' Flute 4' Blockflot 2' Larigot 1 1/2' Sesqui-altera II Oboe 8'

LOWER: Prestant 16' Octave 8' Gedeckt 8' Prestant 4' Flute 4' Quint 2 3/4' Octave 2' Mixture IV Clarinet 8'

PEDAL: Sub Bass 16' + Gedeckt 8' Diapason 8' + Flute 4'

When using the Pipe Organ, the stops are registered through the Drawbars. The “Classic 1” and “Classic 2” types follow the classic organ layout left to right as follows: Flue, Mixture and Reed.

“Classic 1” is a stop complement of a traditional “American Classic” organ while “Classic 2” is a stop complement more suited to Baroque-era music.

On the UPPER and LOWER Parts, each Drawbar corresponds with a pipe organ rank or stop.

On the PEDAL part, two stops sound with one Drawbar (Compound Stop).

NOTE: When either of the “Classic” Custom Pipes is selected, the Drawbars will function in a manner similar to drawstops on a traditional pipe organ - pulling a Drawbar “out” will turn the associated Pipe Voice “ON” while pushing the Drawbar “in” will turn the Pipe Voice “OFF.” The Pipe Voices do not have gradations of volume - they are either “ON” or “OFF.”

NOTE: The labels “F1,” “F2” etc., refer to Custom Pipes. (P. 155)

NOTE: The digital Leslie is not available on the Pipe Voices. However, the Vibrato/Chorus feature becomes a pipe organ Tremulant when the PIPE Organ Type is selected.

Flute 16'	Bass 16'	Flute 8'	Clarinet 8'	Sax 8'	Trumpet 8'	Strings 8'	Flute 4'	Strings 4'	Acc
Bass 16'	Strings 16'	Flute 8'	Oboe 8'	Trumpet 8'	Strings 8'	Flute 4'	Piccolo 4'	Strings 4'	Far
16'	8'	4'	2'	II	III	IV	~	^	Vx
Bourdon 16'	OpenDiap 8'	Gedeckt 8'	VoixClst II	Octave 4'	Flauto 4'	Flute 2'	Mixture III	Hautbois 8'	Pipe

If the ORGAN Type is “Pipe,” refer to the “Pipe” row on the other side of the Drawbars for the correspondence between each Drawbar and the footage.

tips STOP

A single voice or sound on a pipe organ is referred to as a “Stop” due to the fact that air flow is “stopped” (or started) by manipulating the individual controls which turn sounds “ON” or “OFF.”

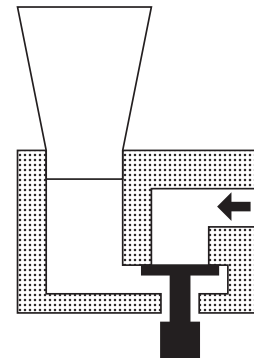

F3: Theatre 1

UPPER:	Tibia Clausa 16'	Vox Humana 8'	Style "D" Trumpet 8'	Tibia Clausa 8'	Clarinet 8'	Viol d'Orch 8'	Vox Humana 8'	Tibia Clausa 4'	Tibia Clausa 2'
LOWER:	Style "D" Trumpet 8'	Open Diapason 8'	Clarinet 8'	Viol d'Orch 8'	Flute 8'	Vox Humana 8'	Open Diapason 4'	Tibia Clausa 4'	Vox Humana 4'
PEDAL:	Tibia 16' + Flute 8'		Diapason 8' + Flute 4'						

The Theatre 1 and Theatre 2 PIPE settings provide a complement of organ stops characteristic of a theatre or "cinema" organ. "Theatre 1" is a stop complement similar to a Wurlitzer "Style 210" while "Theatre 2" is derived from the stops from a Wurlitzer "Style 260 Special," including English Post Horn. The figures on the left show the stop complements for the Theatre 1 and Theatre 2 Custom Pipe sets.

NOTE: When "Theatre 1" or "Theatre 2" is activated, the Drawbars will function in a manner similar to tablets on a theatre organ console - pulling a Drawbar "out" will turn the associated Pipe Voice "ON" while pushing the Drawbar "in" will turn the Pipe Voice "OFF." The Pipe Voices do not have gradations of volume - they are either "ON" or "OFF."

F4: Theatre 2

UPPER:	Tibia Clausa 16'	English Post Horn 16'	Brass Trumpet 8'	Tibia Clausa 8'	Clarinet 8'	Vox Humana 8'	Tibia Clausa 4'	Tibia Clausa 2½'	Tibia Clausa 2'
LOWER:	Brass Trumpet 8'	Open Diapason 8'	Clarinet 8'	Viol Celeste 8'	Oboe 8'	Flute 8'	Vox Humana 8'	Viol Celeste 4'	Flute 4'
PEDAL:	Tibia 16' + Flute 8'		Diapason 8' + Flute 4'						

PERCUSSION

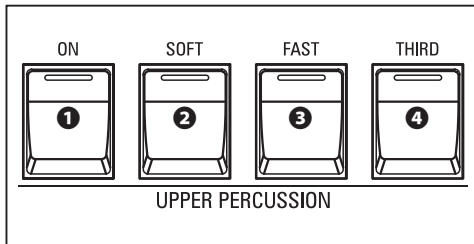

An important component of the Hammond Sound is “Touch-Response Percussion Control™.” The Percussion controls on the XK-4 consist of four separate buttons (shown at left) which control harmonic Percussion tones. These four buttons control all the same functions as the tilt tablets on a vintage Tone Wheel Hammond Organ.

1 [ON] button

This button, when “ON” (LED lit), turns the Percussion effect “ON.” The Percussion tone will sound in accordance with the settings for the other three Percussion controls.

NOTE: In the “ON” position, all of the UPPER Manual Drawbars will be effective except the 1’ (fourth white) Drawbar. This duplicates the performance of a vintage Tone Wheel Organ such as a B-3/C-3. In the “OFF” position, the 1’ Drawbar is effective as usual. However, you can change this Parameter if you wish (see page 71).

2 [SOFT] button

This button regulates the volume of the Percussion tone. When it is “OFF” (LED not lit), the Percussion effect will be very prominent. The Drawbar tones will also be reduced in volume to compensate for the addition of the Percussion tones. When this button is “ON” (LED lit), the Percussion effect is much less prominent. The volume of the Drawbar tones remains unaffected by the addition of the Soft Percussion effect.

3 [FAST] button

When this button is “OFF” (LED not lit) the Percussion tone will decay slowly like a bell. When it is “ON” (LED is lit) the Percussion tone will decay rapidly like a xylophone.

4 [THIRD] button

This button determines the pitch at which the Percussion tone sounds. When set at “SECOND” (LED not lit), the pitch is up one octave with respect to the Fundamental (8’) Drawbar; when set at “THIRD” the Percussion pitch is up an octave and a fifth with respect to the Fundamental Drawbar.

NOTE: The Percussion features works with the “TW” Organ types only, and on the UPPER Part only.

NOTE: You can adjust the Parameters of the Percussion to your liking. See page 102 for more details.

EFFECTS

VIBRATO & CHORUS

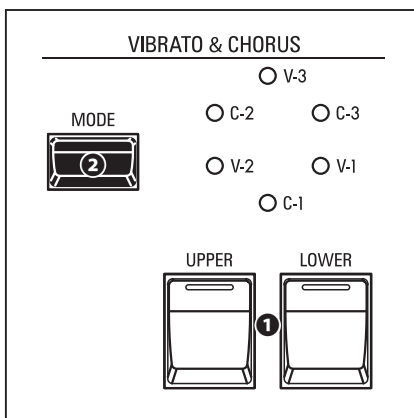

“Vibrato & Chorus” allows you to add “Vibrato” (a periodic raising and lowering of pitch) or “Chorus” (a “shimmering” effect having the periodicity of Vibrato) to your Drawbar registrations.

1 [UPPER], [LOWER] buttons

These allow you to turn Vibrato & Chorus “ON” or “OFF” for each Part. When “ON” the red LEDs will light.

2 [MODE] button

This allows you to select from three degrees of Vibrato and three degrees of Chorus. Each successive press of this button selects a different amount of Vibrato or Chorus.

Organ Type	Effect	MODE
TW	Vibrato & Chorus	V: Vibrato C: Chorus number: depth of the Vibrato or Chorus effect.
Vx, Farf, Ace	Vibrato	Six degrees of Vibrato increasing in intensity from V-1 through C-3.
Pipe	Tremulant	Six degrees of Tremulant increasing in intensity from V-1 through C-3.

NOTE: You can adjust the Vibrato & Chorus effect to your liking. This is explained in more detail on page 72.

LESLIE

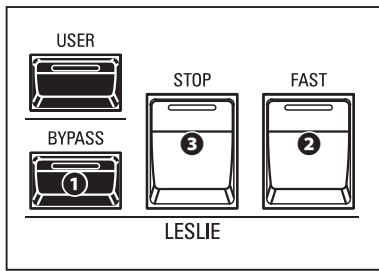

The XK-4 has an inbuilt digital Leslie that replicates the sound of a twin-rotor Leslie Speaker Cabinet.

1 [BYPASS] button

Disables the digital Leslie, producing a “dry” organ sound similar to the sound from a Hammond tone cabinet such as a PR-40.

2 [FAST] button

Toggles between “FAST” (LED lit) and “SLOW” or “STOP” (LED not lit).

3 [STOP] button

Press this button “OFF” (LED not lit) to toggle between “FAST” and “SLOW” when the [FAST] button is “ON” (LED lit).

Press this button “ON” (LED lit) to toggle between “FAST” and “STOP” when the [FAST] button is “ON” (LED lit).

NOTE: The digital Leslie is not available for the Pipe Organ.

NOTE: These controls perform the same functions when a Leslie Speaker Cabinet is connected via the 11-pin socket.

NOTE: You can adjust the Parameters of the inbuilt digital Leslie. See the pages 73 and 100 for more details.

tips LESLIE BUTTONS AND MODES

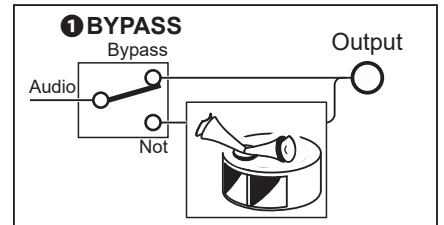
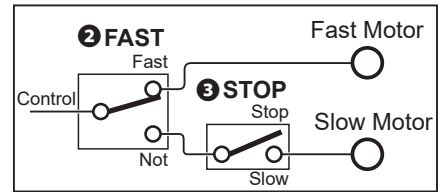

tips WHAT IS THE LESLIE EFFECT?

When the Hammond Organ was first introduced in the mid 1930's, the sound-reproducing apparatus was not contained within the console. A separate “tone cabinet” had to be connected to the organ console via a special cable. For many years, Hammond manufactured tone cabinets specifically for use with Hammond Organs. The best known of these is probably the PR-40 model. In the late 1930's, an independent engineer and organ enthusiast named Donald J. Leslie found that rotating a baffle in front of a stationary speaker created the effect of a tremulant (the well-known “Doppler effect”) and called the subsequent speaker the “Vibratone.” (The “Vibratone” designation was eventually dropped and subsequent models would be known simply as Leslie Speakers.) Many models of Leslie Speakers have been made over the years; probably the best known being the models 122, 142, 145 and 147. The figure below shows the configuration of a typical twin-rotor Leslie Speaker Cabinet. The inbuilt digital Leslie on the XK-4 reproduces all three modes - “FAST,” “SLOW” and “OFF.” In addition, all three modes are available when the XK-4 is connected to an 11-pin Leslie Speaker Cabinet.

OVERDRIVE, REVERB

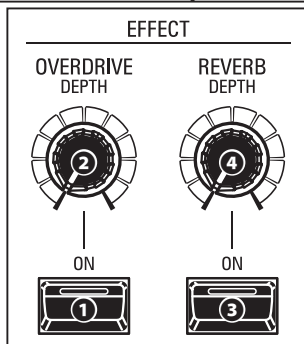

“Overdrive” allows you to add distortion to the sound by increasing the pre-amplifier input gain.

“Reverb” (reverberation) allows you to simulate several different acoustic profiles.

1 OVERDRIVE [ON] button

Turns the Overdrive “ON” and “OFF.”

2 OVERDRIVE [DEPTH] knob

Adjusts the depth of the Overdrive.

NOTE: The Overdrive is not available for the Pipe Organ.

NOTE: You can adjust the Parameters of the Overdrive. (P. 79)

3 REVERB [ON] button

Turns the Reverb “ON” and “OFF.”

4 REVERB [DEPTH] knob

Adjusts the depth of the Reverb.

NOTE: The REVERB [ON] button turns Send “ON” and “OFF” and the [DEPTH] knob adjusts the amount of Return. You can use the REVERB [ON] button to add Reverb smoothly in the middle of a song.

NOTE: You can adjust the Parameters of the Reverb. (P. 84)

MULTI EFFECTS

MULTI EFFECTS such as Tremolo, Delay, Ring Modulator, etc. are Menu features having FUNCTION Modes which are accessible via the MENU/EXIT button and the DIRECTION and PAGE buttons.

NOTE: The Parameters described on this page are Patch Parameters, and can be Recorded to a Patch. For a complete list of all Patch Parameters, please see the APPENDIX starting on page 152.

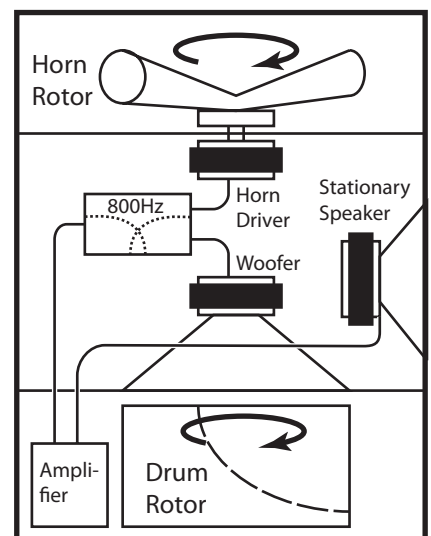

COMBINING PARTS

This instrument can be played as a console organ having Upper and Lower Manuals and Pedals.

KEYBOARD SPLIT

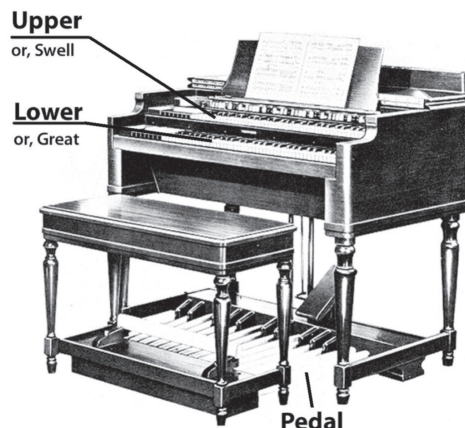
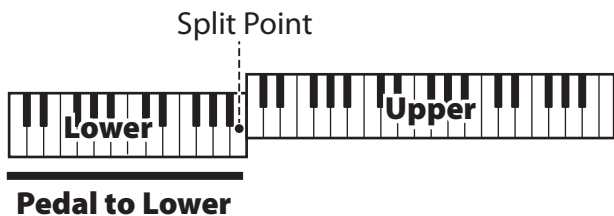

This instrument is a single-keyboard instrument, but by using the SPLIT feature it can be made to perform as if it were a two-manual instrument.

USING THE SPLIT FEATURE

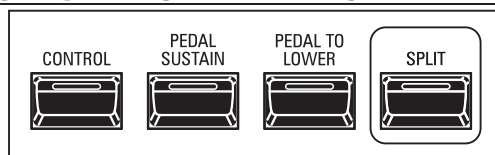

To enable the SPLIT feature, press the [SPLIT] button "ON." The LED will light. When SPLIT is active the left portion of the keyboard is referred to as LOWER while the right portion of the keyboard is UPPER.

NOTE: You can change the SPLIT Point. This is explained in more detail on page 88.

NOTE: The SPLIT does not function when the MIDI IN mode (P. 132) is set at "Upper / Lower," "Lower + Pedal" or "Upper + Pedal."

CHANGING THE OCTAVE

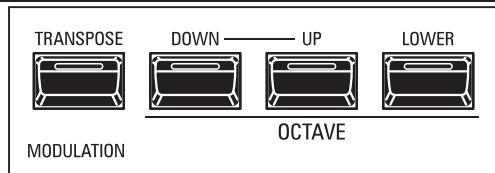

To change the Octave for each keyboard,
UPPER.....Press the OCTAVE [DOWN] or [UP] button.

LOWER.....Press and Hold the [LOWER] button and press the OCTAVE [DOWN] or [UP] button.

The current Octave setting is shown in the display. The button LEDs on the buttons will light if the Octave setting is not "0."

NOTE: This instrument has additional OCTAVE Parameters in addition to the OCTAVE buttons.

These additional Parameters can be used to adjust the Octave settings for the individual Parts of the Internal ORGAN sounds and the External Zones when the instrument is connected to an external MIDI device (P. 67).

tips KEYBOARD AND PARTS

The classic Hammond Organ has two manuals or keyboards and a pedal keyboard (or pedal clavier). Commonly, the two keyboards will be registered differently - for example, the UPPER Keyboard will be registered for Melody while the LOWER Keyboard will be registered for either harmonic accompaniment or playing a bass line. In addition, the PEDALS will have a setting appropriate for bass notes.

This instrument can function as a classic Hammond Organ by dividing or "Splitting" the keyboard into two Parts. This spread explain this in more detail. In addition, the PEDAL Part can be played either from a connected MIDI pedalboard, or from the keyboard by using the PEDAL TO LOWER feature when SPLIT is active.

tips DIFFERENCE BETWEEN "SPLIT" AND "PEDAL TO LOWER"

The "Split" feature divides the keyboard into two Parts - "UPPER" (right of Split point) and "LOWER" (left of Split point). This allows the instrument to function similarly to a Hammond Organ with two keyboards. The PEDAL TO LOWER transfers or couples the PEDAL Part to the portion of the keyboard designated as "LOWER." In addition, you can cause the PEDAL Part to play the lowest note you are holding, or the root note if you are playing a chord on the LOWER portion of the keyboard. In this way, you can play all three Parts - UPPER, LOWER and PEDAL - from the single keyboard.

PEDAL TO LOWER

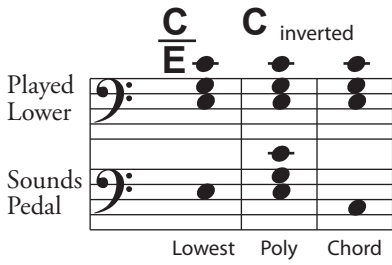

tips TRIGGERING THE PEDAL PART BY USING THE FOOT SWITCH

To triggering the PEDAL part without Pedalboard, you can use the foot switch also. (P. 108)

The **PEDAL TO LOWER** feature allows you to play the PEDAL Part from the LOWER Keyboard (left portion of the keyboard when [SPLIT] is active, or expanded MIDI keyboard).

USING THE PEDAL TO LOWER

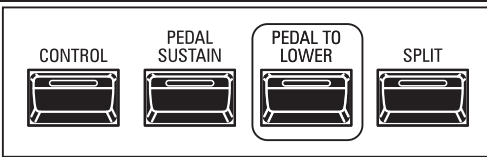

To engage PEDAL TO LOWER, press the [PEDAL TO LOWER] button so the LED lights ON.

NOTE: You can adjust the sounding range or condition of the PEDAL TO LOWER feature. This is explained in more detail on page 88.

PEDAL SUSTAIN

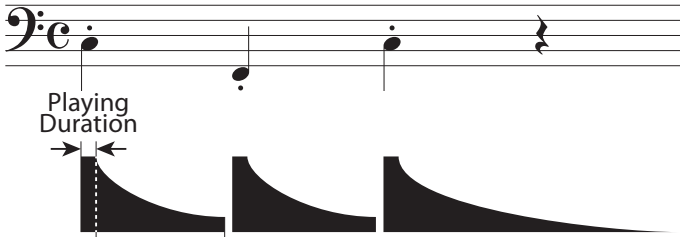

The XK-4 incorporates a feature called **PEDAL Sustain**. When this feature is active, the PEDAL tones will smoothly decay upon release, much in the manner of a string bass.

USING THE PEDAL SUSTAIN

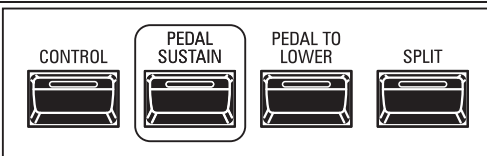

To engage PEDAL SUSTAIN, press the [PEDAL SUSTAIN] button so the LED lights ON.

NOTE: You can adjust the length of the PEDAL Sustain. (P. 70)

NOTE: The Parameters described on this page are Patch Parameters, meaning that different settings can be Recorded to different Patches.

RECORDING A USER PATCH

After you have created your own setting, you can save it as a User Patch (P. 26).

There are two ways to record a Patch.

1. Using the [VALUE] knob,
2. Using the Number buttons.

USING THE [VALUE] KNOB

① PRESS THE RED [RECORD] BUTTON

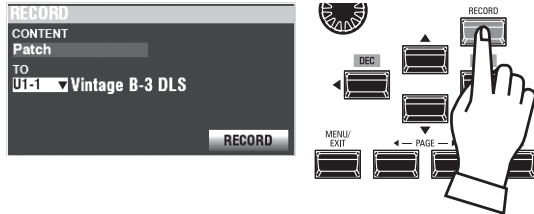

After you have made your changes to a Patch, press the [RECORD] button. The RECORD Page will display.

② SELECT THE ITEM TO RECORD (PATCH)



Use the [VALUE] knob and the DIRECTION buttons to set the CONTENT at "Patch," and the TO at the Patch number you wish to record.

Next, move the cursor on the [RECORD] icon, press the [ENTER] button.

USING THE NUMBER BUTTONS

This procedure is enabled when the FAVORITE Parameter is set to "Off" and ACCESS MODE is set at "(Bank)/Patch." (P. 116)

Example: Record "U5-3" (Bank #5, Number #3).

① SET THE BANK

NOTE: If you are working in the currently selected Bank, you may skip this step.

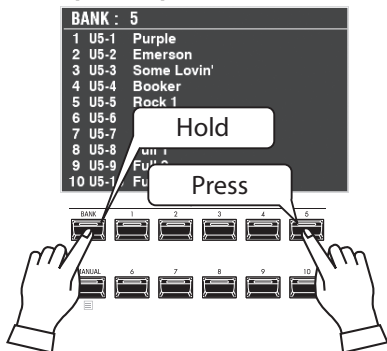

Press and Hold the [BANK] button, and press a NUMBER button which you wish to record Patch Bank ([5] in this example).

The display shows the list of the Patches in the Bank, and all the NUMBER buttons begins flashing for demand the selecting Number.

② SELECT THE NUMBER

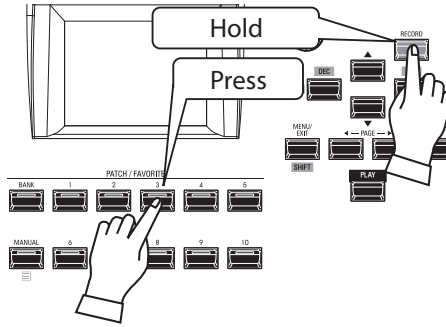

Press and Hold the [RECORD] button, and press any one of the NUMBER buttons ([3] in this example).

NAMING AND RECORDING

③ INPUT THE PATCH NAME

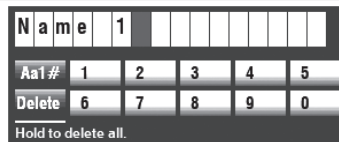

Input the Patch Name.

- [BANK] Change the character group.
- [MANUAL] Delete a letter.
- [1] - [10] Input a letter.
- DIRECTION [◀][▶] Move the cursor.
- [VALUE] knob Change the letter.

④ RECORD THE PATCH

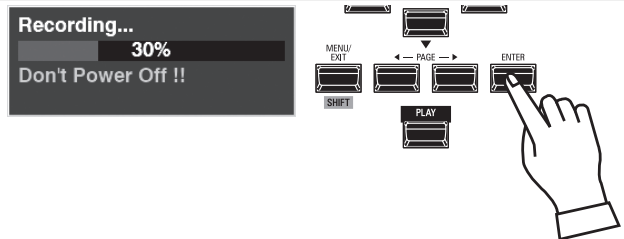

After you are finished Naming, press the [ENTER] button.

NOTE: If you DO NOT wish to Record, press the [MENU/EXIT] or [PLAY] button instead of the [ENTER] button.

The message shown above will display for approximately 1 second.

NOTE: Do not turn the power "OFF" while the above message is displaying.

When the display shows:

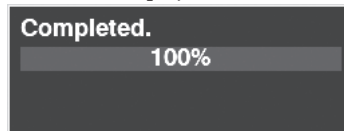

the Recording process is finished and your setting has been Recorded.

These Parameters allows you to shift the musical key and the overall tuning of the entire instrument.

TRANPOSE

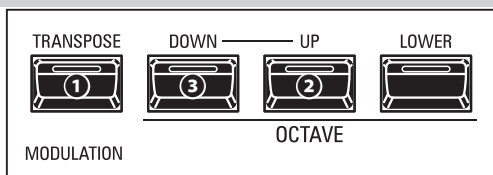

1 TRANPOSE button

- ◆ To raise the pitch by semitone, press and hold the [TRANPOSE] button and press the 2 [UP] button.
- ◆ To lower the pitch by semitone, press and hold the [TRANPOSE] button and press the 3 [DOWN] button.

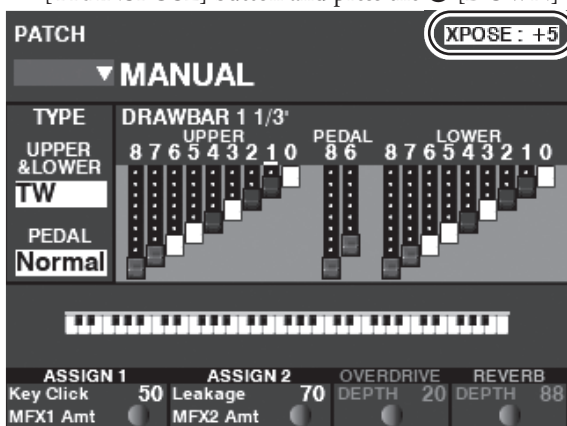

Example: The Transpose is set at "+5."

The Transpose can be set at between -6 to +6 semitones. The Transpose value is shown in the display if it is operated.

WHAT IS AFFECTED BY THE TRANPOSE FUNCTION?

TRANPOSE will affect:

1. The internal sounds of the instrument.
2. MIDI IN Note Data.
3. MIDI Note Data sent OUT to the External Zones.

NOTE: Though TRANPOSE is a System Parameter, when the power to the instrument is turned "OFF," it resets to 0. And it does not recorded to a Patch.

NOTE: You can select whether Transpose changes while notes are being held or when the next note is pressed after releasing the notes being held (P. 112).

MASTER TUNE

This Parameter changes the overall tuning pitch of the entire instrument. The reference pitch is "A-440." The selectable range is from "A-430" through "A-450."

1 LOCATE "MASTER TUNE"

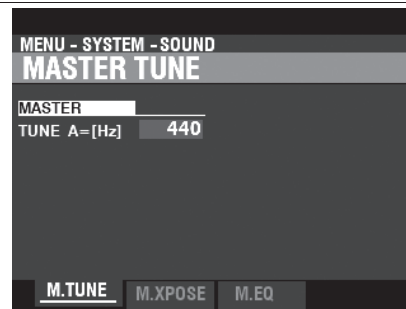

Locate the "Master Tune" Page by operating [MENU/EXIT] button - **SYSTEM - SOUND - MASTER TUNE.**

2 SELECT THE VALUE

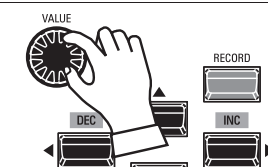

Use the [VALUE] knob to set the pitch.

3 RECORD THE SETTING

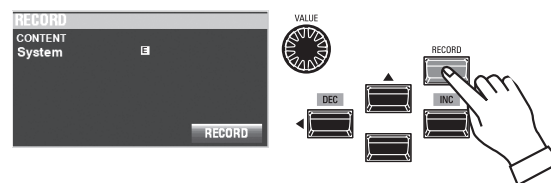

You can Record this setting to be remembered the next time the power is turned "ON."

To do this, press the [RECORD] button in this "MASTER TUNE" page. (P. 118)

NOTE: This parameter is a System Parameter (P. 158), and it is common for all the Patches.

NOTE: All the other changed System Parameters will recorded at same time by this procedure.

4 RETURN TO THE PLAY MODE

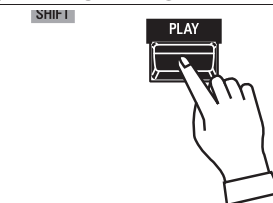

Press the [PLAY] button to return to the PLAY Mode.

RECORDING "MANUAL" SETTINGS

You can Record the Parameters which will be set when the [MANUAL] button (P. 30) is turned "ON" after the instrument is first powered "ON."

① SET THE PARAMETERS ON THE [MANUAL]

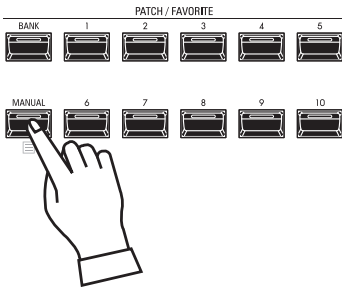

Turn the [MANUAL] button "ON" (LED lit) and adjust button or Patch Parameters to your preference.

② RECORDING OPERATION

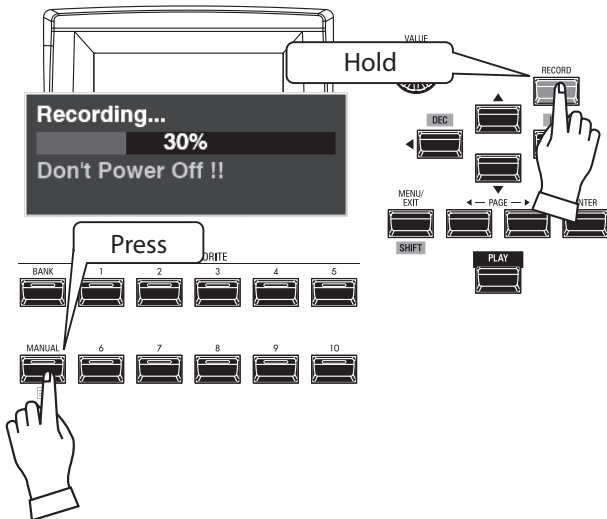

Press and Hold the [RECORD] and [MANUAL] buttons together. The display will show the message shown above. You will see a progress bar similar to the one shown above during the Recording procedure.

When the display shows:

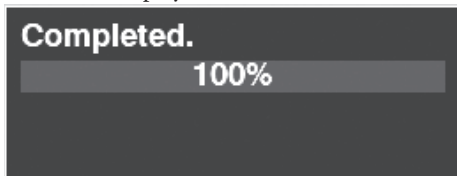

The procedure is finished.

There is one additional operation to complete for Recording [MANUAL] settings. This is explained starting at the right column.

② PRESS THE RED [RECORD] BUTTON

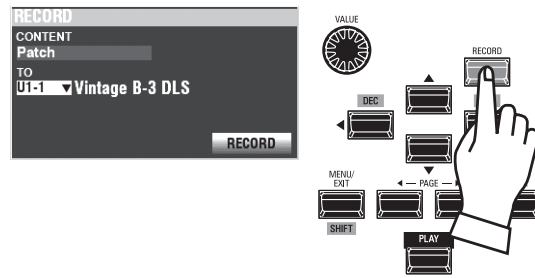

Press the [RECORD] button.
The RECORD dialog box will display.

③ SELECT MANUAL

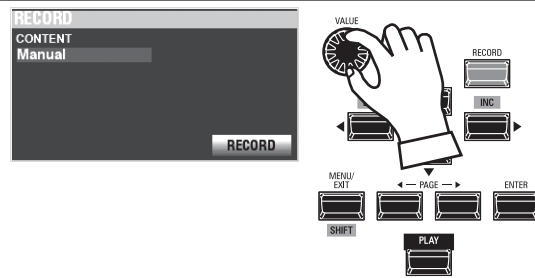

Use the DIRECTION [▲] [▼] buttons and the [VALUE] knob to select Manual for CONTENT.

Next, move the cursor to the [RECORD] icon and press the [ENTER] button.

NOTE: If you DO NOT wish to Record, press the [MENU/EXIT] or [PLAY] button instead of the [ENTER] button.

The display will show;

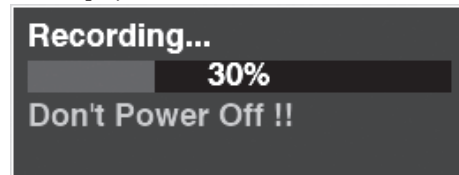

You will see a progress bar similar to the one shown above during the Recording procedure.

When the display shows:

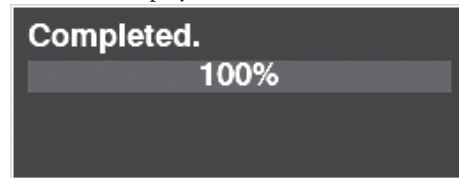

the Recording process is finished.

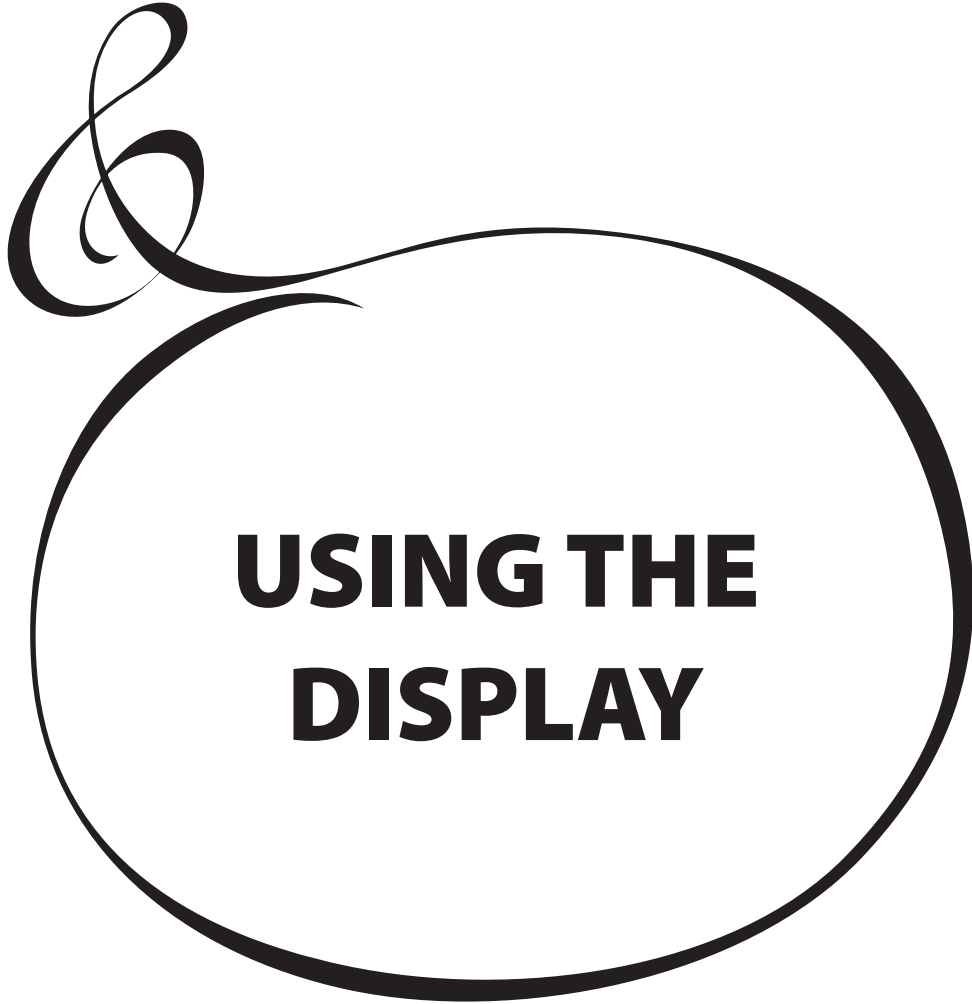

USING THE DISPLAY

The display and buttons on the Information Center allow you to make various adjustments which cannot be accessed from the other controls on the Control Panel. For example, adjustment of the speed of the digital Leslie rotors, or MIDI setup.

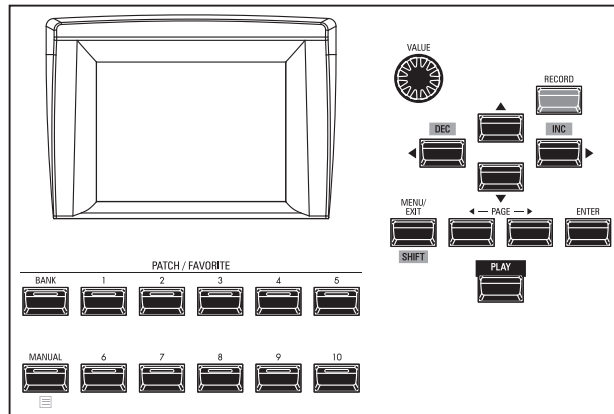

The display has three (3) Modes - PLAY Mode, MENU Mode and FUNCTION Mode. The next pages explain how to read the display in each Mode.

PLAY Mode

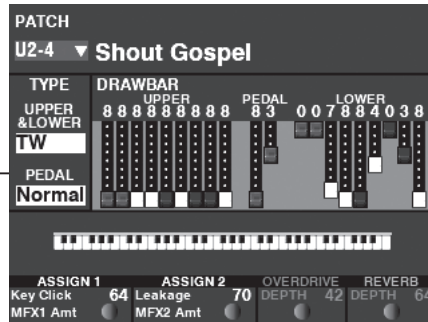

The PLAY Mode allows you to see or modify the current basic settings such as Drawbar settings, Patch Numbers and other information.

MENU Mode

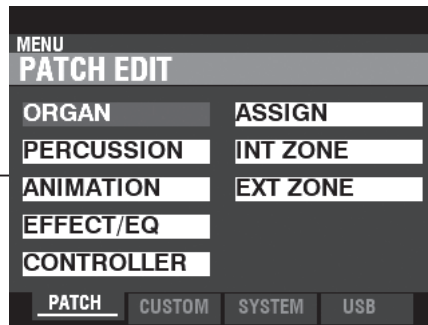

The MENU Mode allows you to see the different FUNCTION Modes where you can customize the instrument.

FUNCTION Mode

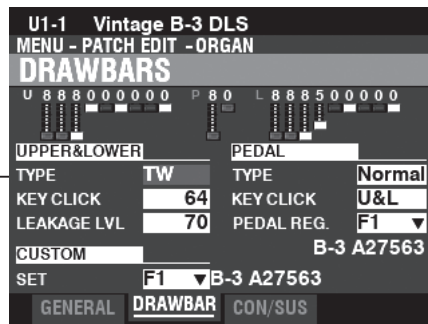

A FUNCTION Mode allows you to change specific Parameters within each MENU Mode.

You can Lock the display in order to prevent accidental changes during live performance, or when more than one musician will be using the same instrument.

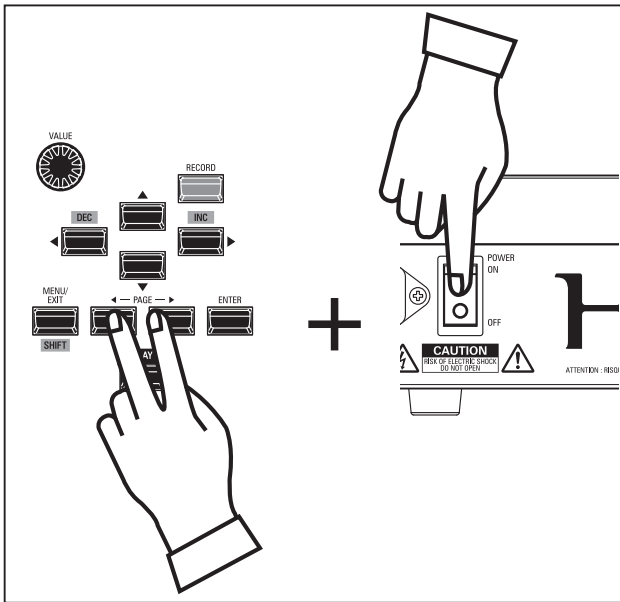

To Lock the display, do the following:

1. With the XK-4 power "OFF," Press and Hold the two PAGE [◀][▶] buttons.
2. While holding the PAGE buttons, turn the XK-4 power "ON." Continue to hold the PAGE buttons until "Confirming Display Locked/Unlocked" is shown in the display.

After approximately 5 seconds, "Display Locked" will show at the bottom of the display. You can then release the PAGE buttons.

To Unlock the display, follow the above two steps. You will see "Display Unlocked" in the display.

When the display is Locked:

1. [MENU/EXIT] is disabled.
2. [RECORD] is disabled.
3. The "Shortcut" feature is disabled.
4. Patches can still be recalled.

NOTE: If the display is Locked, you will see a message in the display when the instrument is first turned "ON:" "Loading...Display Locked."

NOTE: If the display is Locked, holding the red [RECORD] button and applying power will not Unlock it. Follow the procedure described above to Unlock the display.

PLAY MODE

The PLAY Mode is the normal performance mode. The information necessary for ordinary performance will be displayed.

TO LOCATE THIS MODE:

The PLAY Mode is automatically displayed when the instrument is first powered “ON” and the opening screen disappears. If another mode is displayed, press the [PLAY] button.

PLAY MODES

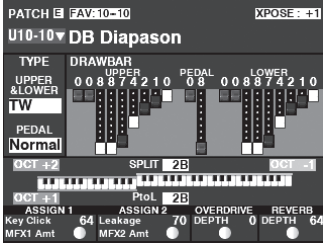

Organ

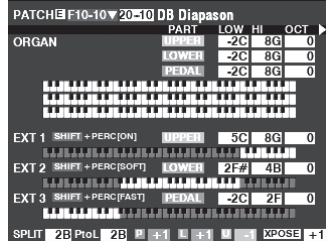

Zones

The PLAY mode has two different pages.

The figure shown on the left is useful for normal performance while the figure on the right shows the current External Zone configuration. This is useful when transmitting to external MIDI devices such as modules, external keyboards, etc.

OPERATION

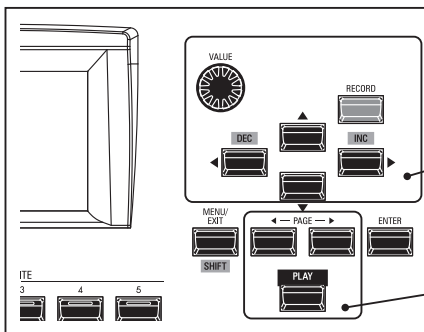

Each PLAY Mode allows you to select the Patches and adjust the Parameters most frequently used.

The PLAY Modes are selected by the [PLAY] or PAGE [◀]/[▶] buttons.

APP (APPLICATION) MENU

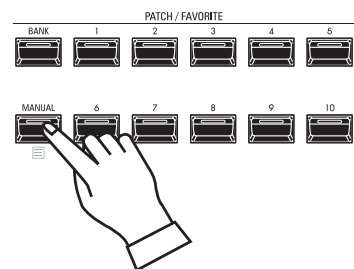
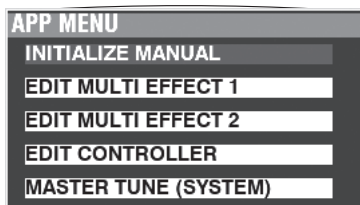

The APP (Application) Menu allows you to select various FUNCTION Mode Pages or special functions (“Jobs”).

To display the APP Menu, do the following:

1. Select a PLAY Mode.
2. Press and Hold the [≡] button. The following Menu options will display:
INITIALIZE MANUALInitialize the MANUAL Parameters.
INITIALIZE PATCH.....Initialize the current Patch Parameters.
EDIT MULTI EFFECT 1Go to the page for MULTI EFFECT 1. (P. 75)
EDIT MULTI EFFECT 2Go to the page for MULTI EFFECT 2. (P. 80)
EDIT CONTROLLERGo to the page for CONTROLLER. (P. 86)
MASTER TUNE.....Go to the page for MASTER TUNE (System Parameter). (P. 51)

To select an option:

1. Use the DIRECTION [▲]/[▼] buttons to highlight the option you want.
2. Press the [ENTER] button to select the desired option.

NOTE: The MANUAL feature is explained in more detail on page 30.

HOW TO READ THE DISPLAY (ORGAN)

The PLAY Mode (ORGAN) is the first Mode displayed when the instrument is first turned “ON.”

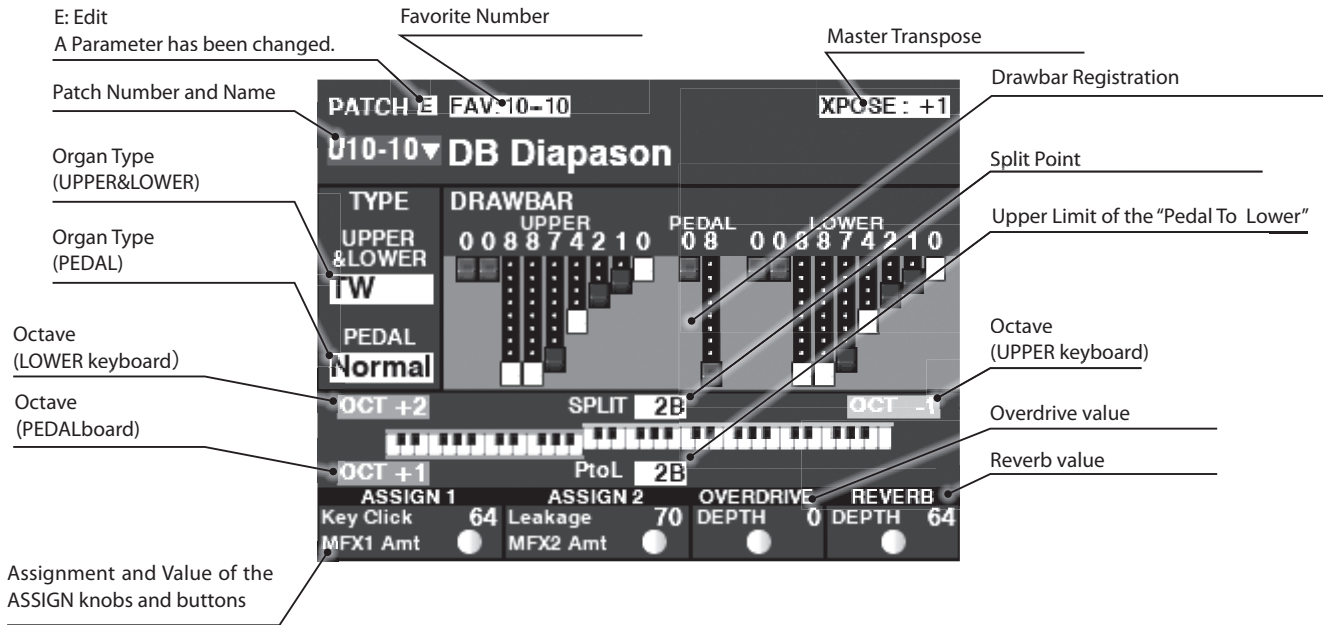

HOW TO READ THE DISPLAY (ZONES)

To locate this PLAY Mode (ZONES), press the [PLAY] again or PAGE[◀/▶] buttons several times.

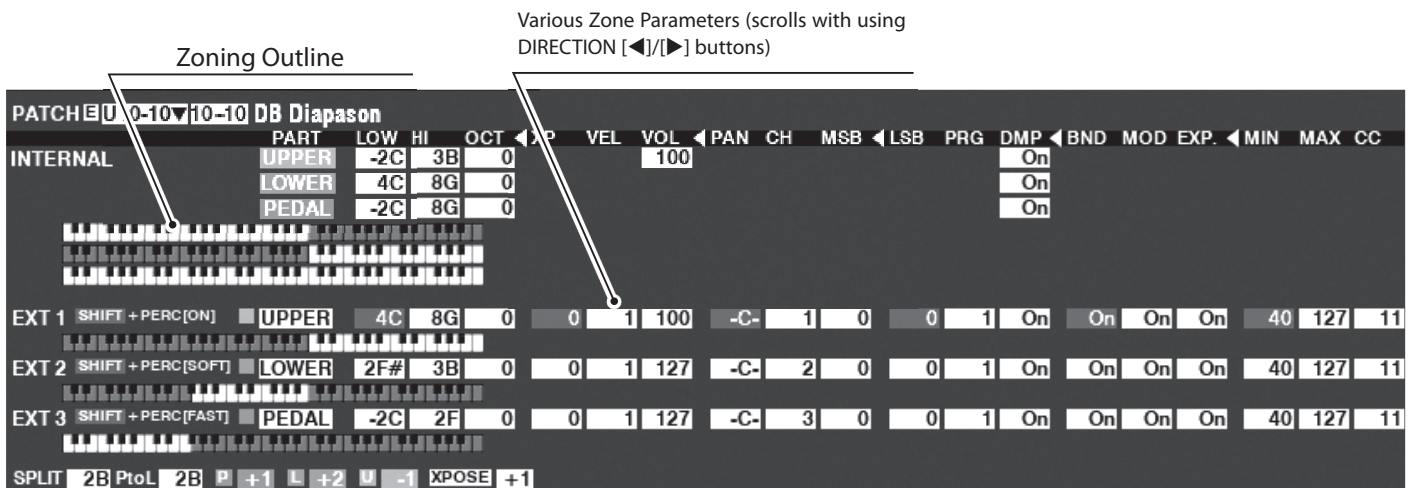

The Internal Zones (P. 88) and the External Zones (P. 89) are advanced features for controlling internal sound engine or external MIDI equipment.

When the [ZONE] Play Page is displayed, you can select whether you want each External Zone to transmit MIDI data by Pressing and Holding the [SHIFT] button and pressing the [ON], [SOFT] or [FAST] buttons to turn MIDI transmission “ON” or “OFF” for each External Zone (see the illustration on the right).

To allocate an External Zone to a specific Part:

1. Locate the cursor to the PART you want.
2. Use the [VALUE] knob to select “UPPER,” “LOWER,” “PEDAL” or “OFF”

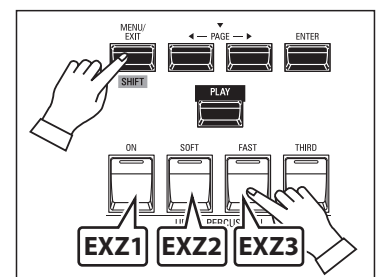

MENU MODE

As explained earlier, the MENU Mode allows you to see the different FUNCTION Modes where you can customize the instrument.

To locate this mode:

Press the [MENU/EXIT] button.

The MENU Mode has four Pages.

Use the PAGE [◀]/[▶] buttons to scroll through the Pages.

Use the DIRECTION buttons to select the desired FUNCTION Mode.

After doing the above, press the [ENTER] button to enter the desired FUNCTION Mode.

HOW TO READ THE DISPLAY

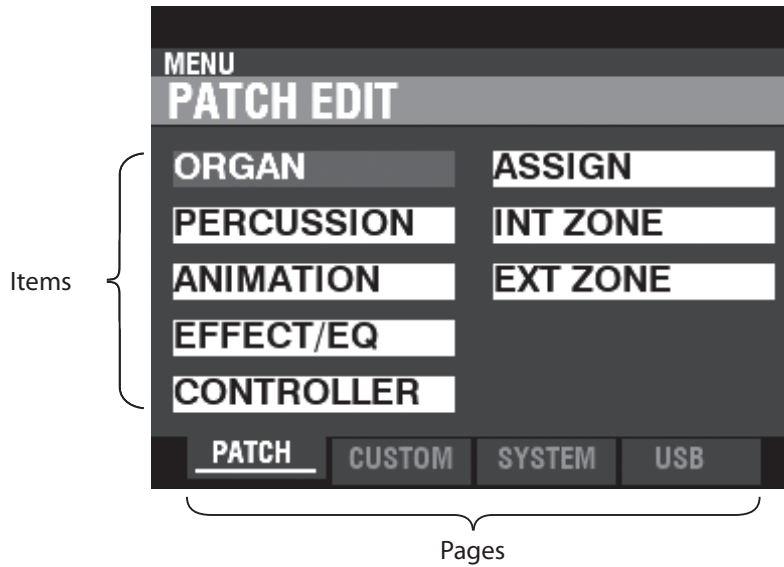

OPERATION IN THIS MODE

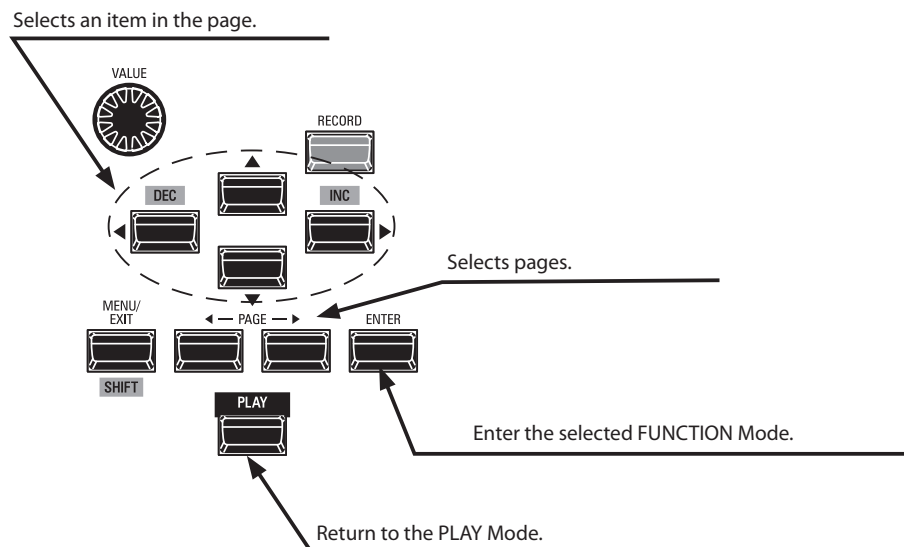

MENU MODE CONTENTS

PATCH (P. 66)

1. ORGAN (P. 67)

This allows you to adjust the basics of an ORGAN Patch such as Volume, Sounding range, Virtual Multi-Contacts, etc.

2. PERCUSSION (P. 71)

This allows you to make various changes to the characteristics of the Percussion.

3. ANIMATION (P. 72)

This allows you to adjust the Vibrato & Chorus of the Tone Wheel Organs, Vibrato for the Transistor Organs, and Tremulant for the Pipe Organ as well as the digital Leslie.

4. EFFECT / EQ (P. 74)

This allows you to adjust effects such as Overdrive, Reverb, Chorus, etc., as well as to adjust the Equalizer.

5. CONTROLLER (P. 86)

This allows you to adjust how you want the Pitch Bend and Modulation Wheels and a Damper Pedal to function with each Patch.

6. ASSIGN (P. 87)

This allows you to assign various functions to the ASSIGN knobs and buttons.

7. INTERNAL ZONE (P. 88)

This allows you to adjust how the keyboard will control the functions of the internal sound engine such as [SPLIT] or Coupler.

8. EXTERNAL ZONE (P. 89)

This allows you to adjust the Parameters for transmitting to external MIDI devices.

CUSTOM (P. 93)

1. TONE WHEEL (P. 94)

This allows you to edit the characteristics of the Tone Wheel Organ.

2. PEDAL REG. (P. 99)

This allows you to edit the harmonics used by the PEDAL Drawbars of the Tone Wheel Organ.

3. LESLIE (P. 100)

This allows you to edit the inbuilt digital Leslie.

4. PIPE (P. 102)

This allows you to select and edit each Pipe Organ Stop.

SYSTEM (P. 105)

1. SOUND (P. 106)

This allows you to adjust Master Tune, Transpose, and Master Equalizer.

2. AUDIO (P. 107)

This allows you to adjust the audio configuration between Voice Sections and output jacks.

3. CONTROL (P. 108)

This allows you to adjust the Parameters for the various controllers such as Foot Switch, Expression Pedal, Display and Keyboard.

4. PATCH LOAD (P. 114)

This allows you to select which contents are loaded when a Patch is selected.

5. FAVORITE (P. 116)

This allows you to select and edit Favorites.

6. MIDI (P. 132)

This allows you to adjust MIDI Channels, and various messages for the MIDI port and the USB MIDI.

7. GLOBAL (P. 115)

This allows you to adjust the Auto Power Off time.

8. DEFAULT (P. 119)

This allows you to initialize all or part of the XK-4 to factory settings.

9. INFORMATION (P. 120)

This allows you to see which jacks on the Accessory Panel are currently active and which version of software is currently installed. Also allows you to update the software.

USB FLASH DRIVE

1. LOAD (P. 140)

This allows you to Load Setups, Patches or Custom File from the USB Flash drive.

2. SAVE (P. 139)

This allows you to Save Setups, Patches, Custom Files, etc., to the USB Flash drive.

3. DELETE (P. 141)

This allows you to Delete Setups, Patches or Custom Files, from the USB Flash drive.

4. FORMAT (P. 137)

This allows you to initialize the USB Flash drive.

FUNCTION MODE

The FUNCTION Mode allows you to see and adjust the various Parameters. This is explained in more detail starting below.

HOW TO READ THE DISPLAY

E(Edited) Mark, Patch Number and Name.

Level in this mode

Cursor

Parameter

Value

Page

OPERATION IN THIS MODE

Adjusts the value.
The value will increase or decrease by steps.
The value will increase or decrease by coarse steps while holding [SHIFT] button.

Selects an item in the page.
Increases/decreases the value by steps by pressing the [INC] / [DEC] buttons while holding the [SHIFT] button.

Moves up one level in this Mode.

Moves the pages.

Selects the icon in the page.

Return to the PLAY Mode.

tips LIST SELECTION

A "▼" showing in the display indicates multiple selections are available. To open a List Menu, move the cursor to one of the values shown in the display and press the [ENTER] button. You can select an available option either by using the [VALUE] knob or Pressing and Holding the [SHIFT] button and pressing the [DEC] / [INC] buttons. To close the List, press the [ENTER] button again.

APP (APPLICATION) MENU

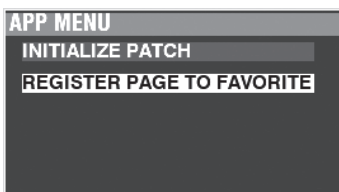

The APP (Application) Menu allows you to select certain FUNCTION Mode Pages or to perform special operations called **Jobs**.

Press the [=] button to see the APP Menu for the FUNCTION Modes.

Press and Release the [=] button to see the APP Menu in PLAY or MANUAL Mode.

To select an item in an APP Menu:

1. Use the [▲]/[▼] buttons to highlight the option you want.
2. Press and Release the [ENTER] button to select the desired option.

EXAMPLE OF OPERATION

① GO TO THE MENU MODE

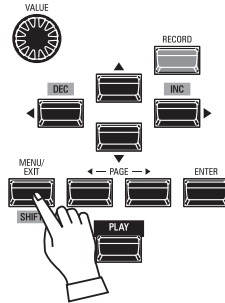
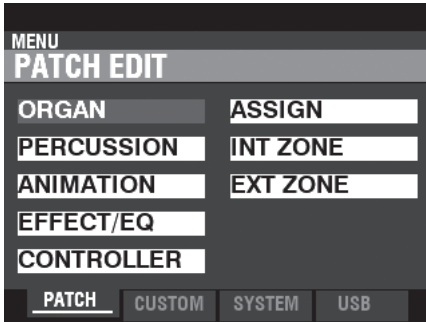

This example will show you how to select a Leslie Cabinet.

Press the [MENU/EXIT] button. The MENU Mode will appear.

② MOVE THE PAGE IN THE MENU MODE

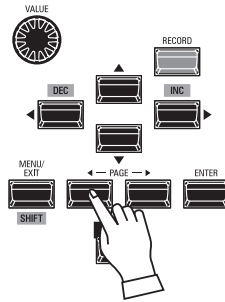
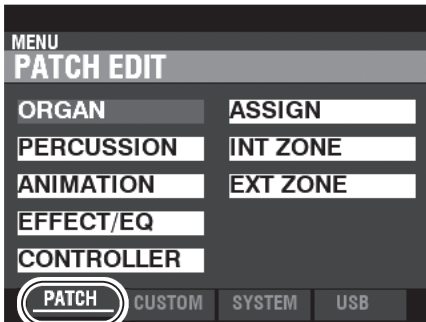

Use the PAGE [◀]/[▶] buttons to select the different Pages in each Menu.

For this example, the PATCH Edit Menu is already displayed so it is not necessary to touch either of the PAGE [◀]/[▶] buttons.

③ SELECT THE ITEM IN THE PAGE AND ENTER THE FUNCTION MODE

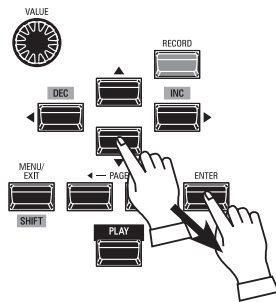
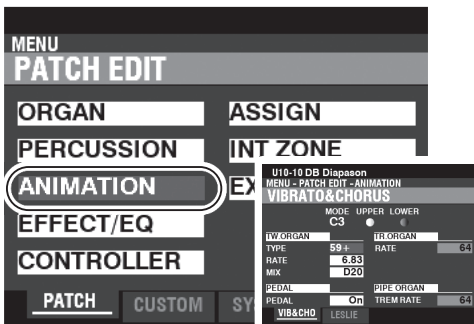

Use the DIRECTION buttons to select the item to edit.

For this example, press the [▼] button to select “ANIMATION.”

Press the [ENTER] button to select each FUNCTION Mode.

For this example, it entered VIBRATO & CHORUS page of the ANIMATION Function group.

④ MOVE THE PAGE IN THE FUNCTION MODE

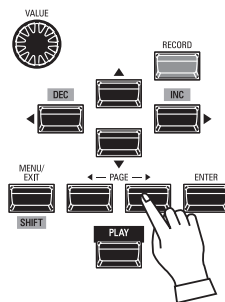
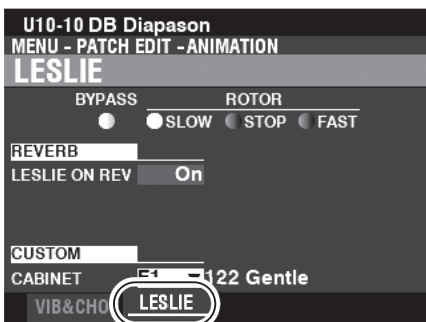

Use the PAGE [◀]/[▶] buttons to select the individual FUNCTION Mode Page you want to edit.

For this example, press the [▶] button to select the LESLIE Function Page.

62 FUNCTION MODE - continued

5 MOVE THE CURSOR TO THE PARAMETER

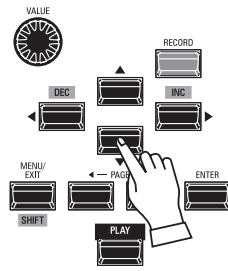
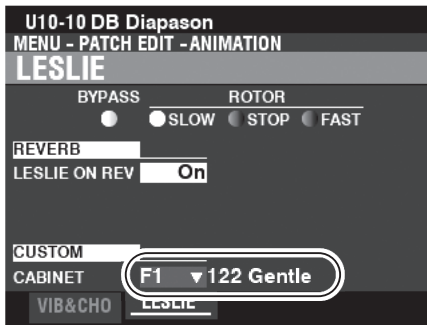

Use the DIRECTION buttons to move the cursor to the Parameter you wish to adjust. For this example, select “CUSTOM CABINET.”

6 CHANGE THE VALUE

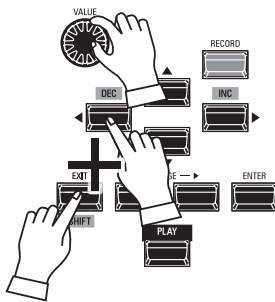
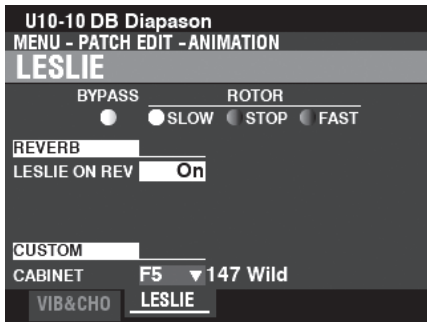

Use the [VALUE] knob to change the selected value. For this example, increase the value by turning the [VALUE] knob to the clockwise.

NOTE: You can also change values by using the [DEC] / [INC] buttons while Press and Hold the [SHIFT] button.

NOTE: To change other Parameters, repeat steps 1 through 6 above and on the previous page.

7 RECORD THE PATCH

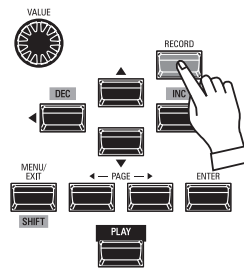
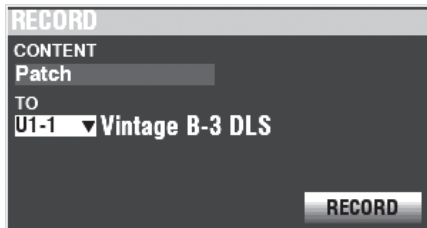

These settings are “temporary,” and will not be remembered if another Patch is selected, or if the instrument is turned “OFF.”

To Record your settings, see page 91.

8 RETURN TO THE PLAY MODE

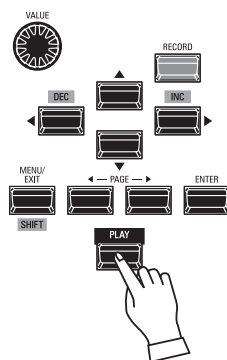
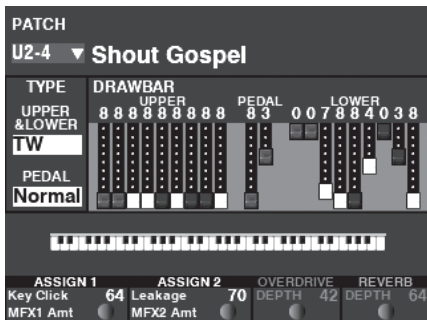

Press the [PLAY] button to return to the PLAY Mode.

To make programming quicker and easier, many of the buttons on the Control Panel can be used to access the FUNCTION Mode associated with that button instantaneously. This is called a “Shortcut.”

Pressing and Holding any of the buttons or turning any of the knobs while holding the [SHIFT] button on the Control Panel automatically “shortcuts” the display to the related FUNCTION Mode.

SHORTCUT EXAMPLE:

LOCATE THE PERCUSSION FUNCTION Mode

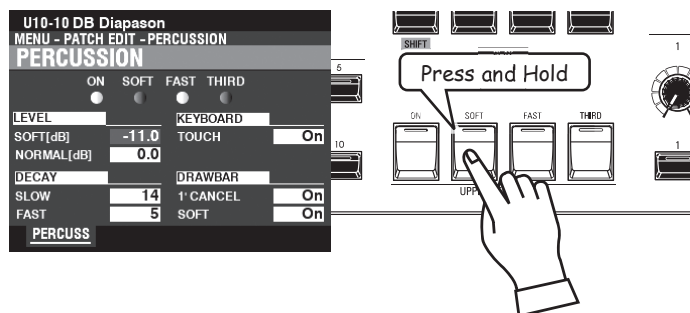

If you wish to edit the Percussion settings, Press and Hold any of the four Percussion buttons ([ON], [SOFT], [FAST], or [THIRD]) and the display will immediately show the Percussion FUNCTION Mode.

NOTE: You can change the Display Shortcut time. This is explained in more detail on page 112.

IF YOU FREQUENTLY USE A CERTAIN PAGE...

You can assign a frequently-used FUNCTION Mode to one of the [FAVORITE] buttons for immediate access, even if that particular FUNCTION Mode is not normally accessible via a Shortcut.

REGISTER

① LOCATE THE PAGE

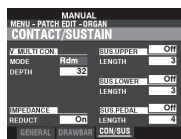

Press the [MENU/EXIT] button to enter MENU Mode and use the DIRECTION and PAGE buttons to locate the specific FUNCTION Mode you want.

② SET THE FAVORITE NUMBER TO REGISTER THE PAGE

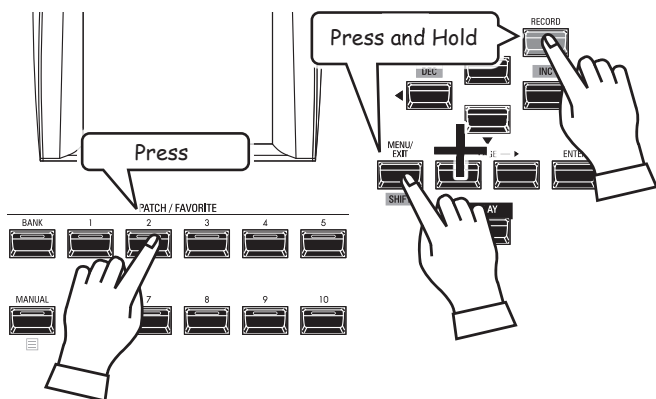

1. Touch and Hold the [SHIFT] and [RECORD] buttons together.
2. While holding the two buttons, touch any of the Number buttons.

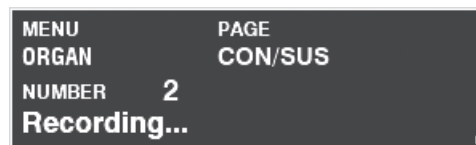

The message shown above will display for approximately 1 second.

DISPLAY THE REGISTERED PAGE

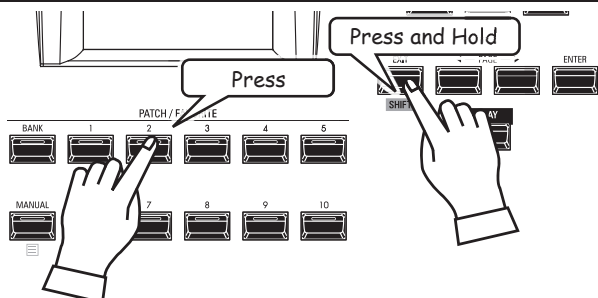

To display the Registered Page, Press and Hold the [SHIFT] button and press the Number button.

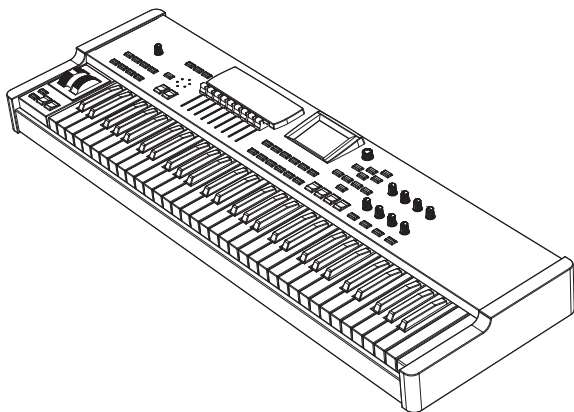



**EDITING
PARAMETERS**

PATCH

“PATCHES” are the basic memory units of the XK-4 which store various Parameter settings and which can be recalled during performance. A Patch can contain not only settings of the buttons and knobs on the Control Panel but also MENU Parameters.

To locate this mode:

[MENU/EXIT] - **PATCH**

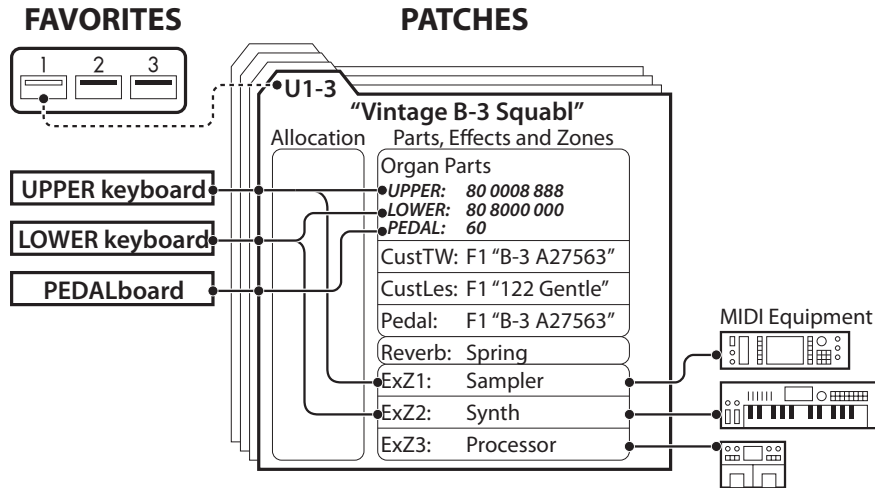

MENU AND CONTENTS

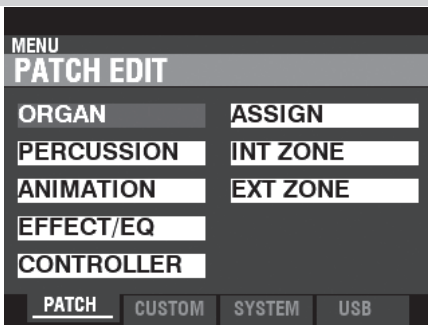

- 1. ORGAN (P. 67)**
This allows you to adjust the basic components of the Organ sound.
- 2. PERCUSSION (P. 71)**
This allows you to adjust the characteristics of the UPPER PERCUSSION.
- 3. ANIMATION (P. 72)**
This allows you to adjust the Animation features such as Vibrato/Chorus and Leslie.
- 4. EFFECT/EQ (P. 74)**
This allows you to adjust various effects such as Overdrive, Multi Effects, Reverb, etc., as well as an Equalizer.
- 5. CONTROLLER (P. 86)**
This allows you to adjust Parameters for the Pitch Bend and Modulation Wheels and a Damper Pedal.
- 6. ASSIGN (P. 87)**
This allows you to assign various functions to the [ASSIGN] knobs and buttons.

7. INTERNAL ZONE (P. 88)

This allows you to determine how the keyboard will interact with the internal sound engine.

8. EXTERNAL ZONE (P. 89)

This allows you to configure Zones for controlling external MIDI devices.

APP (APPLICATION) MENU

To display the APP Menu, Press and Release the [≡] button. The following Menu options will display:

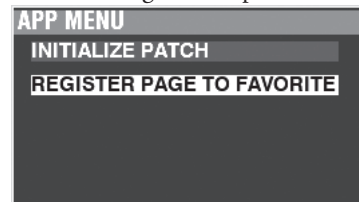

The APP (Application) Menu allows you to perform the following special operations, called **Jobs**:

INITIALIZE PATCH

.....Initializes all the Patch parameters for the currently selected.

REGISTER PAGE TO FAVORITE

.....Registers the current page to the Favorite.

To select an option:

- Use the DIRECTION [▲]/[▼] buttons to highlight the option you want.
- Press the [ENTER] button to select the desired option.

See page 92 for a more detailed description of the APP Menu Jobs.

This FUNCTION Mode allows you to adjust the basic components of the Organ sound such as Patch Volume, Sounding Range, Organ Type, Virtual Multi Contact, etc.

To locate this mode:

[MENU/EXIT] - PATCH - ORGAN - [ENTER]

GENERAL

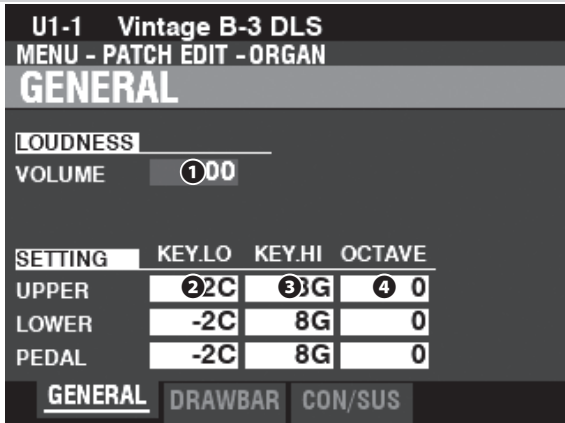

This Page allows you to adjust Patch Volume, as well as the Sounding Ranges and Octave settings for each Part.

1 VOLUME

Setting Range: 0 ~ 127

This allows you to adjust the volume of the selected Patch.

2 KEY RANGE LOW

3 KEY RANGE HIGH

Setting Range: -2C ~ 8G

This allows you to adjust the sounding range for each Part.

4 OCTAVE

Setting Range: -2 ~ 0 ~ 2

Sets octave for each Part.

NOTE: The actual octave in which a Part will sound will be the sum of this Parameter plus the OCTAVE setting of the Internal Zone. See page 88 for more information about Octaves.

tips LOUDNESS - VOLUME

The LOUDNESS - VOLUME Parameter adjusts the total volume of the Patch after Effects have been added. Use this Parameter to adjust volume balance between and among Patches.

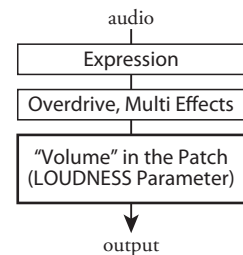

DRAWBARS

Shortcut: DRAWBAR SELECT [UPPER] and [PEDAL] buttons together or, [SHIFT] + any Drawbars

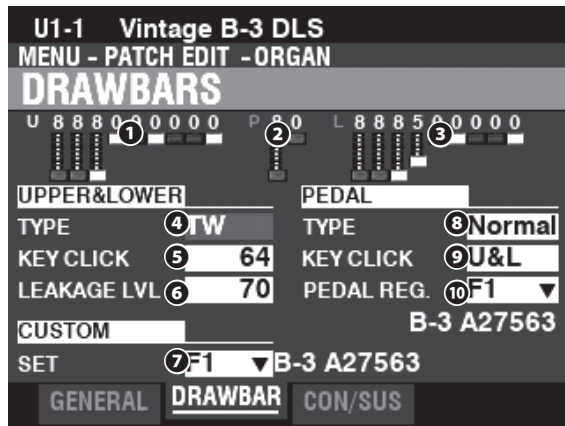

This Page allows you to adjust the Drawbar Parameters for each Part.

- 1 UPPER Registration
- 2 PEDAL Registration
- 3 LOWER Registration

This allows you to see the Drawbar Registrations for each Part.

UPPER & LOWER DRAWBARS

These Parameters allow you to adjust the characteristics of the Drawbars for the UPPER and LOWER Parts.

4 TYPE

This allows you to select the ORGAN Type.

- TW**.....Tone Wheel Organ such as B-3/C-3.
- Vx.**.....Reproduces the sound of a vintage British Transistor Organ.
- Farf**.....Reproduces the sound of a vintage Italian Transistor Organ.
- Ace**.....Reproduces the sound of a vintage Japanese Transistor Organ.
- Pipe**.....Pipe Organ.

5 KEY CLICK LEVEL

Setting Range: 0 ~ 127

TW	Vx.	Farf	Ace	Pipe
✓	✓	✓	✓	

This allows you to adjust the intensity of the Virtual Multi-Contacts for the UPPER and LOWER Parts.

At “0,” the note will sound with no “click” at the onset of the sound as with a traditional electronic instrument.

A higher value will create a faster attack as well as introduce Key Click.

6 LEAKAGE LEVEL

Setting Range: 0 ~ 127

TW	Vx.	Farf	Ace	Pipe
✓				

This allows you to adjust the total volume of the Leakage Tone.

A higher value will result in a louder Leakage Tone.

7 CUSTOM SET

Setting Range: F1 ~ F4, U1 ~ U4

TW	Vx.	Farf	Ace	Pipe
✓				✓

This allows you to select a customized set for each Tone Wheel Organ and Pipe Organ.

tips DISABLED PARAMETERS

All of the ORGAN Parameters affect the Tone Wheel Organs; however, some of the ORGAN Parameters do not affect the Transistor or Pipe Organs - for example, Leakage Level, PEDAL Type and Custom Tone Wheels. If a particular Parameter does not affect the selected Organ Type, it will be “greyed out” or darkened in the display (see the example below). However, the value of a disabled Parameter can still be adjusted using the [VALUE] knob.

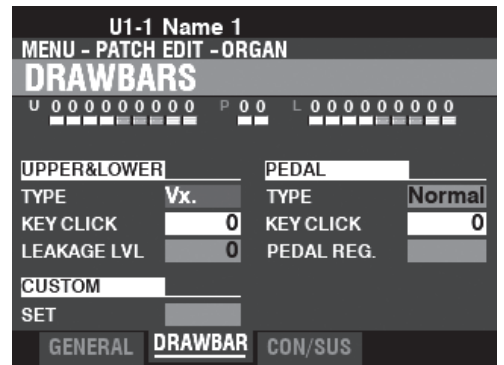

tips KEY CLICK

On Tone Wheel organs such as the B-3/C-3, each time a key is depressed 9 electrical switch contacts are closed by means of 9 horizontal flat springs which touch 9 busbars. Each time a contact is closed or released, a “key click” was produced. This characteristic is replicated on the XK-4.

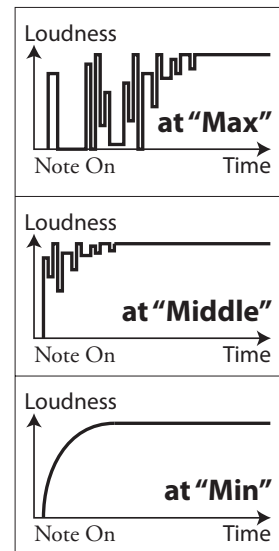

How the “Key Click Level” works.

tips LEAKAGE TONE

On a vintage B-3/C-3, there may be a slight amount of signal leak between notes (page 97). The XK-4 replicates this feature.

NOTE: See page 155 for list of Custom Sets.

PEDAL

8 TYPE

Settings: Normal, Muted

TW	Vx.	Farf	Ace	Pipe
✓				

This allows you to select the ORGAN Type for the PEDAL Part.

Normal.....Traditional tone-wheel registration of the B-3/C-3/A-100.

Muted.....Analog pedal tones as on the classic X-5.

NOTE: When one of the Transistor Organs (Vx., Farf. or Ace.) is selected for the UPPER & LOWER, Muted is automatically selected for the PEDAL Part.

NOTE: When the Pipe Organ Type is selected for the UPPER & LOWER Parts, Pipe is automatically selected for the PEDAL Part and the other PEDAL Parameters are unavailable.

9 KEY CLICK LEVEL

Settings: Off, U&L

TW	Vx.	Farf	Ace	Pipe
✓	✓	✓	✓	

This allows you to adjust the intensity of the Virtual Multi-Contacts for the PEDAL Part.

Off.....The note will sound with no “click” at the onset of the sound as with a traditional electronic instrument.

U&L.....Linked with UPPER & LOWER 5.

10 SUB DRAWBARS

Setting Range: F1 ~ F4, U1 ~ U4

TW	Vx.	Farf	Ace	Pipe
✓				

This allows you to select the harmonic settings for the PEDAL or Sub Drawbars when the “Normal” Type 8 and “TW” Type 4 is selected.

NOTE: The Parameters described on these pages are Patch Parameters and can be Recorded to individual Patches. For a complete listing of all Patch Parameters, please consult “PATCH PARAMETERS” (P. 152) .

CONTACT/SUSTAIN

Shortcut: [PEDAL SUSTAIN]

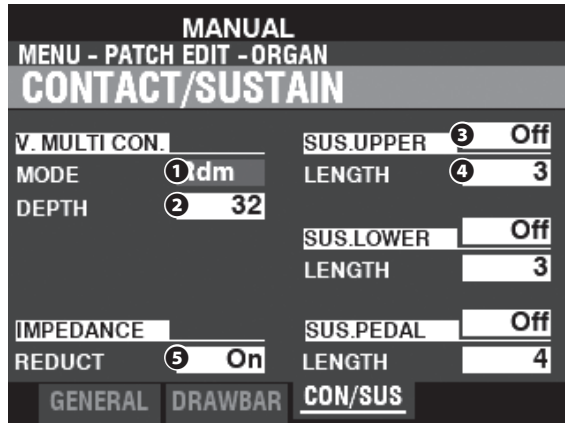

This Page allows you to adjust Virtual Multi Contact and Sustain effects.

VIRTUAL MULTI-CONTACT

1 MODE

This allows you to select how the Virtual Multi-Contacts (“VMC’s”) will sound when keys are depressed.

Random.....When a key is depressed, each contact of the VMC’s will connect in a random order at the shallow point, and all the contacts are fully made when the key reaches its deep point.

Velocity.....When a key is depressed to its deep point, each contact of the VMC’s is made by a time difference depending on the velocity.

NOTE: When the SOUNDING POINT (P. 113) is set at “Deep” and this parameter is set at “Random,” the Virtual Multi-Contacts will all sound at the Deep point simultaneously.

2 DEPTH

Setting Range: 0 ~ 127

This allows you to adjust the amount of time for each VMC to sound when a key is depressed.

At “0” all the VMC’s sound simultaneously. The higher the value, the longer the time interval between contacts.

SUSTAIN UPPER / LOWER / PEDAL

This allows you to add a smooth decay to the UPPER, LOWER and PEDAL Drawbar tones.

3 SWITCH

Settings: Off, On

This allows you to turn Sustain “ON” or “OFF” on the selected Part.

NOTE: If Sustain is “ON,” all of the Virtual Multi-Contacts will fade out at the same rate and no Key Click or Delay is applied to the Release of the notes.

NOTE: SUS. PEDAL is linked with [PEDAL SUSTAIN] button on the Control Panel.

4 LENGTH

Setting Range: 1 ~ 5

This allows you to adjust the length of the Sustain effect for the selected Part.

IMPEDANCE

5 REDUCTION

Settings: Off, On

This allows you to select whether the volume will be slightly reduced when multiple keys are pressed and held and additional keys are pressed.

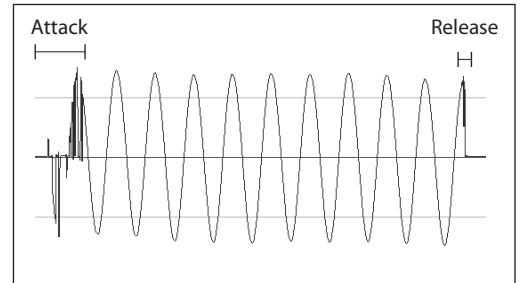

Play with staccato on the B-3/C-3.

tips WHAT ARE CONTACTS?

When a key is depressed on a tone-wheel Hammond Organ, it closes 9 small electrical switch contacts. These 9 contacts represent the 9 pitches provided by the Drawbars. The contacts are closed and opened by means of 9 horizontal flat springs which touch 9 busbars. When a flat spring touches a busbar, electrical contact is made and the harmonic is permitted to sound. Since the 9 busbars are physically separated, the harmonics do not all sound simultaneously, but in succession. This can be heard most clearly by selecting one of the four Manual Drawbar sets of a tone-wheel organ, pulling all of the Drawbars out to their maximum volume setting and slowly pressing a playing key. Each of the harmonics will add in a sequence from highest to lowest until all 9 frequencies will be heard when the key is at the bottom of its travel. The “Key-Click” on tone-wheel Hammond Organs is due to these physical characteristics. Also, if a key is released quickly it will bounce at the time of contact, creating an effect known as “Key Bounce” or “Chattering.”

tips SUSTAIN

The word “Sustain” has a different meaning for an electronic organ than for a synthesizer. On an electronic organ, “Sustain” refers to a note or notes continuing to sound and smoothly decaying after the key is released. This is called “Release” on a synthesizer.

tips WHAT IS IMPEDANCE?

“Impedance” here refers to the AC load on a Tone Wheel generator. When a key is depressed, it is “loaded down” by the circuits related to the contacts under the key being depressed. When more keys using the same Tone Wheels are depressed, the Tone Wheel is loaded down further, causing a slight volume drop on those notes.

This FUNCTION Mode allows you to adjust the characteristics of the UPPER PERCUSSION.

To locate this mode:

[MENU/EXIT] - PATCH - PERCUSSION - [ENTER]

Shortcut: UPPER PERCUSSION [ON], [SOFT], [FAST], or [THIRD]

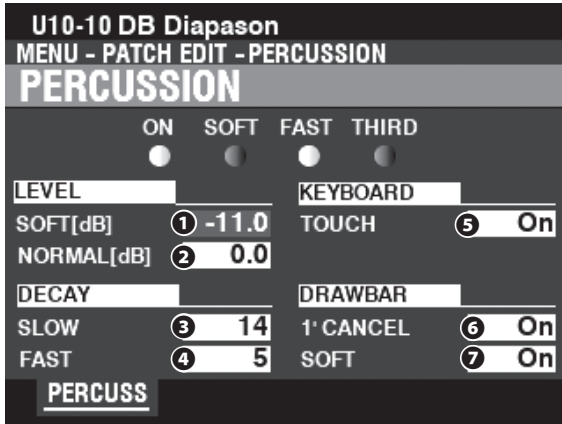

This Page allows you to make changes to the Percussion tones.

LEVEL

1 SOFT

2 NORMAL

Setting Range: -22.0 ~ +10.5 dB

This allows you to adjust the Percussion Volume levels for both the “SOFT” and “NORMAL” Volume settings.

DECAY

3 SLOW

4 FAST

Setting Range: 1 ~ 24, Cont

This allows you to adjust the Percussion Decay time.

A higher value will result in a slower Decay. If “Cont” (Continuous) is selected, the Percussion tone will sound continuously with no decay when keys are pressed and held.

KEYBOARD

5 TOUCH

Settings: Off, On

This allows you to adjust the Touch Response of the Percussion.

On.....Percussion will sound only if you play the keys in a detached manner (non-legato). Any degree of detachment is sufficient.

Off.....Each key will sound when played regardless of whether other keys are being held.

DRAWBARS

6 1' CANCEL

Settings: On, Off

This allows you to cancel the UPPER 1' Drawbar while using Percussion.

On.....The 1' Drawbar will be canceled when Percussion is “ON.”

Off.....The 1' Drawbar will continue to sound when Percussion is “ON.”

7 DRAWBAR - SOFT

Settings: On, Off

This allows you to reduce the UPPER Drawbar volume while using the Percussion if the [SOFT] button is “OFF” (LED not lit).

On.....The volume level of the Drawbars will be reduced by a small amount when Percussion is “ON” at Normal volume.

Off.....The volume of the Drawbars will remain at the same level when Percussion is “ON” at Normal volume.

tips TOUCH

The percussion generator on the B-3/C-3 had a single envelope, which would not recycle until all keys were raised. Originally thought to be a defect, the resulting response became a desired trait.

tips 1' CANCEL

The B-3/C-3 had no exclusive key contact for the Percussion, but, used the 1' contact. The XK-4 replicates this feature.

tips SOFT

On a vintage B-3/C-3, when Percussion was turned “ON” and the Volume setting was “NORMAL,” the UPPER Manual Drawbars were slightly reduced in volume. The XK-4 replicates this feature.

NOTE: The Parameters described on these pages are Patch Parameters and can be Recorded to individual Patches. For a complete listing of all Patch Parameters, please consult “PATCH PARAMETERS” (P. 152).

This FUNCTION Mode allows you to adjust the Animation features such as Vibrato/Chorus and Leslie.

To locate this mode:

[MENU/EXIT] - PATCH - ANIMATION - [ENTER]

VIBRATO & CHORUS

Shortcut: Press and Hold the VIBRATO and CHORUS [MODE], [UPPER] or [LOWER] buttons.

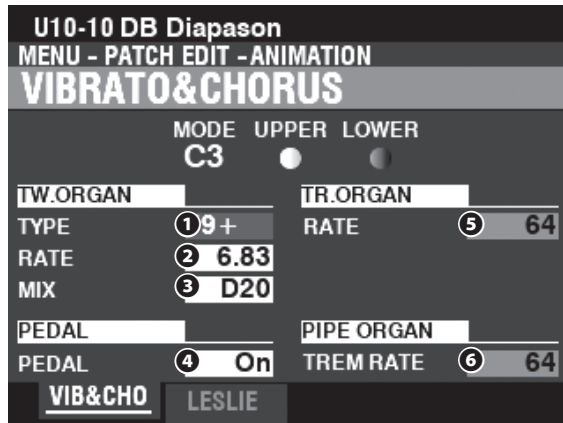

This Page allows you to adjust the Vibrato & Chorus of the Tone Wheel Organs, Vibrato for the Transistor Organs, and Tremulant for the Pipe Organ.

TONE WHEEL ORGAN

① TYPE

Settings: See below

This allows you to select the Vibrato Delay Line type.

'55-57Metal Box (1955 - 1957).

'57-59Big Silver Box (1957 - 1959).

'59+Small Silver Box (1959 or later).

② RATE

Setting Range: 5.78 ~ 7.90 Hz (349 ~ 475 rpm)

This allows you to adjust the rate of the Vibrato & Chorus.

③ MIX

Setting Range: D64 ~ Even ~ 63V

This allows you to adjust the intensity of the Chorus (C1 to C3).

"D" = direct or dry sound. "V" = Vibrato sound.

PEDAL

④ PEDAL

Settings: Off, On

This allows you to select whether the Vibrato & Chorus affects the PEDAL Part when the Vibrato & Chorus [LOWER] button is "ON."

TRANSISTOR ORGAN

⑤ RATE

Setting Range: 0 ~ 127

This allows you to adjust the rate of the Vibrato.

PIPE ORGAN

⑥ TREMULANT RATE

Setting Range: 0 ~ 127

This allows you to adjust the rate of the Tremulant.

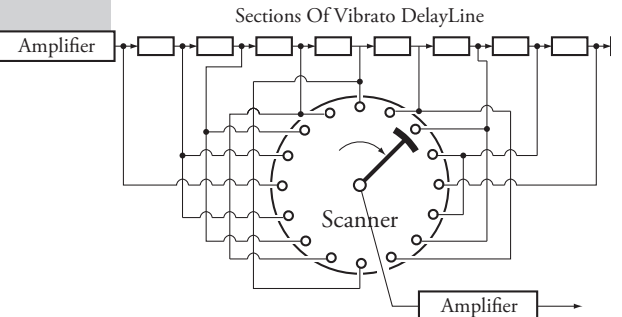

tips VIBRATO & CHORUS

The illustration above shows the vibrato equipment of a Tone Wheel Hammond Organ such as a B-3/C-3.

On a Tone Wheel Hammond Organ equipped with Vibrato & Chorus, the vibrato circuitry consists of a series of plural coils or low-pass filter sections called a "delay line" or "line box" and a motor-driven "scanner" which scans the delay line and progressively retards the phase, creating the Vibrato effect.

tips VIBRATO TYPE

Hammond tone-wheel organs with Vibrato & Chorus were manufactured from 1949 through 1975. During that time, several different types of vibrato circuits were employed, particularly line boxes of different constructions. The Vibrato TYPE feature replicates the effect of different types of Vibrato delay lines.

tips MIX

"Vibrato Chorus," is obtained when the vibrato output signal is mixed with a portion of signal without vibrato. This creates a "shimmering" effect much used by jazz, blues and rock organists. This Parameter allows you to adjust the balance between the Vibrato and non-Vibrato signals to create the type of Chorus effect you want.

tips PEDAL

On the B-3/C-3, the Vibrato and Chorus affects the PEDAL tones in addition to the LOWER Manual Drawbar tones. Also, starting with the B-2/C-2, vintage organs had **Selective Vibrato**, meaning that Vibrato could be had on UPPER and LOWER Manuals/PEDAL independently (on previous models the Vibrato and Chorus affected the entire organ). These are replicated on this instrument.

tips VIBRATO (TRANSISTOR ORGAN)

On an electronic organ, Vibrato is accomplished by modulating the frequency produced by the master oscillators. This effect is replicated on this instrument.

tips TREMULANT

On a pipe organ, a **Tremulant** varies the air pressure the air pressure to the pipes periodically, producing a vibrato or tremolo effect. On this instrument, Tremulant can be applied to the Pipe Voices.

LESLIE

Shortcut: Press and Hold the LESLIE [BYPASS], [STOP] or [FAST] button.

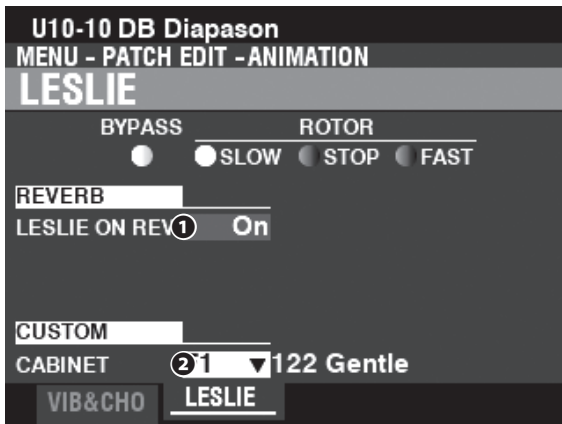

This Page allows you to adjust the Parameters affecting the inbuilt digital Leslie for the Tone Wheel and Transistor Organs.

REVERB

① LESLIE ON REVERB

Settings: Off, On

This allows you to adjust the routing of the Reverb.

Off The digital Leslie modulates the ORGAN sounds only.

On The digital Leslie modulates both the ORGAN sounds and the Reverb.

NOTE: This Parameter does NOT affect a connected Leslie Speaker Cabinet.

CABINET

② CUSTOM CABINET

Setting Range: F1 ~ F8, U1 ~ U8

This allows you to select a Custom Leslie Cabinet.

NOTE: See page 100 for more information about Custom Leslie Cabinets.

tips LESLIE ON REVERB

When an audio signal containing Reverb is sent to a Leslie Cabinet, the Reverb is modulated along with the main signal. This characteristic can be replicated using this Parameter.

When this Parameter is "OFF," the effect is that of a Leslie Cabinet speaking into an auditorium or a large live room, or a Leslie Cabinet having a separate Reverb amplifier and speakers such as a vintage 122RV - the Organ tones are affected by the Leslie rotors but not the Reverb.

When this Parameter is "ON," the effect is that of an audio signal containing both Organ tones and Reverb being fed into a single-channel Leslie - the rotors will modulate the Reverb as well as the basic Organ tones.

NOTE: The Parameters described on these pages are Patch Parameters and can be Recorded to individual Patches. For a complete listing of all Patch Parameters, please consult "PATCH PARAMETERS" (P. 152).

This FUNCTION Mode allows you to adjust various effects such as Overdrive, Multi Effects, Reverb, etc., as well as an Equalizer which can be adjusted for different settings on each Patch.

To locate this mode:

[MENU/EXIT] - **PATCH - EFFECT/EQ** - [ENTER]

This FUNCTION Mode contains below effects or Pages.

1. MATCHING TRANSFORMER (P. 74)
2. MULTI EFFECT 1 (P. 75)
3. OVERDRIVE (P. 79)
4. MULTI EFFECT 2 (P. 80)
5. REVERB (P. 84)
6. PATCH EQUALIZER (P. 85)

MATCHING TRANSFORMER

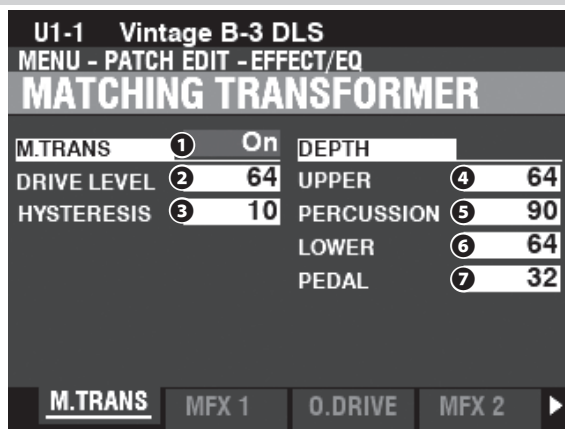

This Page allows you to adjust the Parameters affecting the Matching Transformer for the Tone Wheel Organs.

M.TRANS (MATCHING TRANSFORMER)

1 SWITCH

Settings: Off, On

This allows you to turn the Matching Transformer effect “ON” or “OFF.”

2 DRIVE

Setting Range: 0 ~ 127

This allows you to select the saturation level of the Matching Transformer. A higher value will result in more saturation at low volume levels.

3 HYSTERESIS

Setting Range: 0 ~ 127

This allows you to select the strength of the hysteresis characteristics. The higher the value, the more “asymmetrical” the sound.

DEPTH

4 UPPER (UPPER DRAWBARS)

5 PERCUSSION

6 LOWER (LOWER DRAWBARS)

7 PEDAL (PEDAL DRAWBARS)

Setting Range: 0 ~ 127

This allows you to select the amount of the Matching Transformer modeling for each Part and for the Percussion.

The higher the value, the deeper the effect.

tips

WHAT IS A “MATCHING TRANSFORMER?”

The purpose of the Matching Transformer in a Hammond Tone Wheel organ is to “match” the low Impedance of the generator and key circuits to the high impedance amplifier input.

It combines the individual tones from each Drawbar into one complex musical tone.

Doing this imparts some unique characteristics to the sound (see the illustrations below), which are part of the tonal characteristics of a Hammond Tone Wheel organ such as the B-3/C-3.

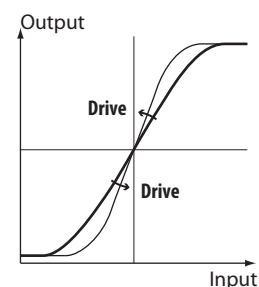

How the Trans - Drive works

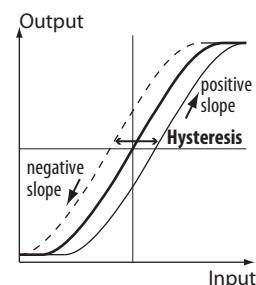

How the Trans - Hysteresis works

MULTI EFFECT 1

App. Menu: PLAY - [≡] - EDIT MULTI EFFECT 1 - [ENTER]

Multi Effect 1 contains the effects listed below which are inserted at pre-Overdrive or Expression (P. 34).

1. TREMOLO

Tremolo is a periodic raising and lowering of the amplitude or volume at a determined rate.

2. WAH-WAH

Wah-Wah is a periodic emphasis and de-emphasis of upper frequencies by means of a frequency filter to impart a speech-like quality to the sound.

3. RING MODULATOR

Ring Modulation is a signal-processing effect whereby two different frequencies are mixed together in such a way as to reduce or eliminate the individual frequencies themselves, leaving only the sum and the difference of the two frequencies.

4. COMPRESSOR

Compressor detects the volume of the source, and reduces or emphasizes the amount of volume change.

MULTI EFFECT 1

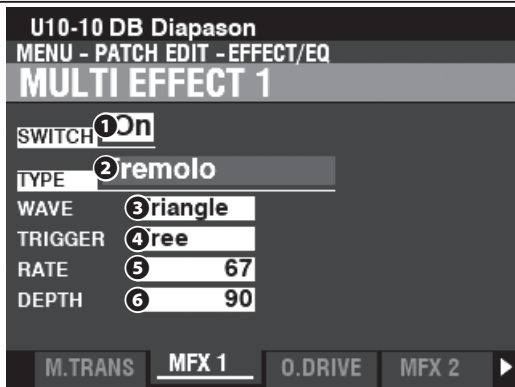

1 SWITCH

Settings: Off, On

This allows you to turn a MULTI EFFECT 1 "ON" or "OFF."

2 TYPE

Settings: Tremolo, Wah-Wah, Ring Mod., Compressor

This allows you to select a Multi Effect.

Each Multi Effect has different Parameters. This is explained starting at the right column.

Tremolo

Tremolo is a periodic raising and lowering of the amplitude or volume at a determined rate.

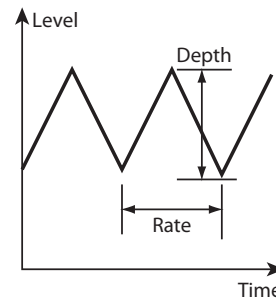

3 WAVE (WAVEFORM)

This allows you to select which waveform is used to modulate the volume.

Triangle Triangle wave.

Square Square wave.

Saw Down Sawtooth Downward wave.

S & H Sample and Hold.

Dull Sqr Dull Square wave.

4 TRIGGER

This allows you to adjust whether the phase of the modulating waveform will reset each time a key is depressed.

Free Pressing a key will intercept the LFO at whatever point it happens to be in its cycle.

Single The LFO of each note oscillates individually. Each LFO will start its cycle when a key is depressed.

5 RATE

Setting Range: 0 ~ 127

This allows you to adjust the modulation rate.

A higher value results in a faster rate.

6 DEPTH

Setting Range: 0 ~ 127

This allows you to adjust the depth of the modulation.

At "0" there is no change in volume - the depth increases as the value increases. At "127" the Tremolo alternates between no sound and maximum volume.

NOTE: The Parameters described on these pages are Patch Parameters and can be Recorded to individual Patches. For a complete listing of all Patch Parameters, please consult "PATCH PARAMETERS" (P. 152).

Wah-Wah

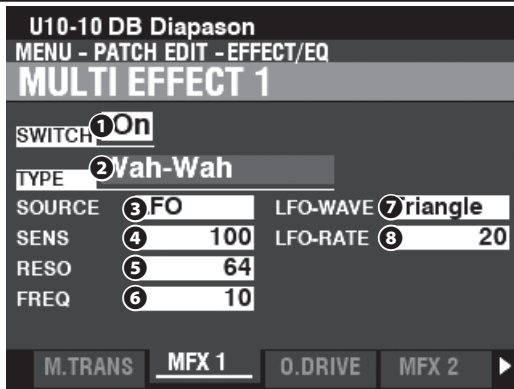

Wah-Wah is a periodic emphasis and de-emphasis of upper frequencies by means of a frequency filter to impart a speech-like quality to the sound.

3 SOURCE

Settings: Manual, Exp, LFO, Input

This allows you to select how to modulate the Wah-Wah effect.

Manual.....The central frequency is determined a fixed value.

Exp.....Allows you to use the Expression Pedal.

LFO.....Allows a cyclical modulation using a dedicated LFO-Low Frequency Oscillator.

Input.....Allows you to use the input audio envelope of the sound engine.

NOTE: When "Manual" is selected the central frequency is basically fixed; however its value can be determined by the **6** FREQ (Frequency) Parameter, the [MODULATION] wheel (P. 86) or the ASSIGN [1] [2] knobs (P. 87).

4 SENS (SENSITIVITY)

Setting Range: 0 ~ 127

This allows you to adjust the sensitivity or width of the effect.

A higher value results in a wider dynamic response.

5 RESO (RESONANCE)

Setting Range: 0 ~ 127

This allows you to boost the cut-off frequency of the Low-Pass Filter and create a more pronounced "Wah" effect.

A higher value results in a greater resonance.

6 FREQ (FREQUENCY)

Setting Range: 0 ~ 127

This allows you to adjust the central frequency.

A higher value increases the frequency.

7 LFO WAVE (WAVEFORM)

Settings: Triangle, Square, Saw Down, S & H

This allows you to select the waveform of the LFO.

Triangle..... Triangle wave.

Square..... Square wave.

Saw Down..... Sawtooth Downward wave.

S & H..... Sample and Hold.

NOTE: The SOURCE must be set to "LFO" to use this Parameter.

8 LFO RATE

Setting Range: 0 ~ 127

This allows you to adjust the rate of the LFO.

A higher value results in a faster rate.

NOTE: The SOURCE must be set to "LFO" to use this Parameter.

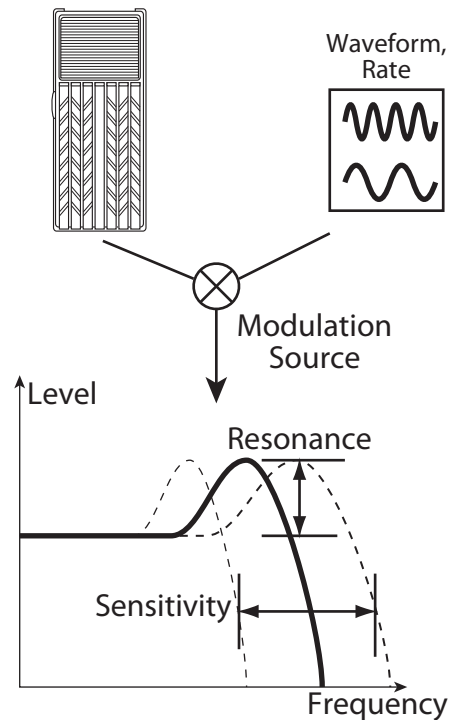

Ring Mod.

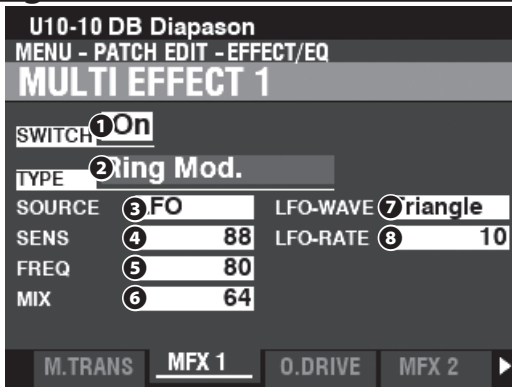

Ring Modulation is a signal-processing effect whereby two different frequencies are mixed together in such a way as to reduce or eliminate the individual frequencies themselves, leaving only the sum and the difference of the two frequencies.

3 SOURCE

Settings: Manual, Exp, LFO, Note

This allows you to select how to modulate the ring frequency.

Manual.....The Ring frequency sounds at a fixed value.

Exp.....Allows you to use the Expression Pedal.

LFO.....Allows a cyclical modulation effect using a dedicated LFO-Low Frequency Oscillator.

Note.....Allows you to assign a ring frequency to the UPPER Keyboard.

NOTE: When “Manual” is selected the Ring frequency is basically fixed; however its value can be determined by the 5 FREQ (Frequency) Parameter, the [MODULATION] wheel (P. 86) or the ASSIGN [1] [2] knobs (P. 87).

4 SENS (SENSITIVITY)

Setting Range: 0 ~ 127

This allows you to adjust the sensitivity or width of the Exp or LFO.

A higher value results in a wider excursion of the Exp or LFO.

NOTE: The SOURCE must be set to “Exp” or “LFO” to hear this effect.

5 FREQ (FREQUENCY)

Setting Range: 0 ~ 127

This allows you to adjust the central ring frequency.

A higher value results in a higher central frequency.

6 MIX

Setting Range: 0 ~ 127

This allows you to adjust the volume balance between the “dry” and the effect sounds.

At “0” only the “dry” sound is heard. The effect level becomes greater as the value increases. At “64” the ratio between the “dry” and the effect sounds becomes 1:1. At “127,” only the effect sound is heard.

7 LFO WAVE (WAVEFORM)

Settings: Triangle, Square, Saw Up, S & H

This allows you to select the waveform of the LFO.

Triangle.....Triangle wave.

Square.....Square wave.

Saw Up.....Sawtooth Upward wave.

S & H.....Sample and Hold.

NOTE: The SOURCE must be set to “LFO” to use this Parameter.

8 LFO RATE

Setting Range: 0 ~ 127

This allows you to adjust the rate of the LFO.

A higher value results in a faster rate.

NOTE: The SOURCE must be set to “LFO” to hear this effect.

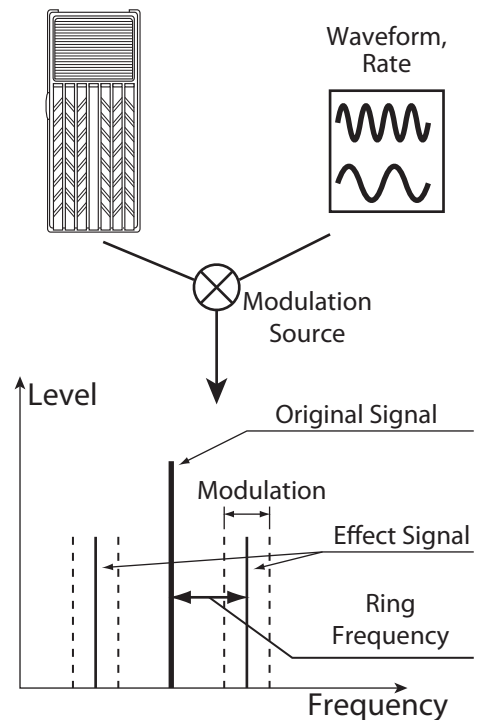

tips RING MODULATION

“Ring modulation” in analog circuits is accomplished by arranging diodes in a circle or ring, giving rise to the term, “ring modulator.” The result is a sound rich in overtones and typically having somewhat of a bell-like or metallic quality. Because of this, the sound is sometimes called a “Klang tone.”

Compressor

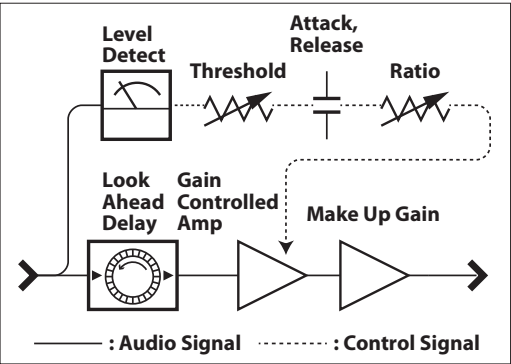
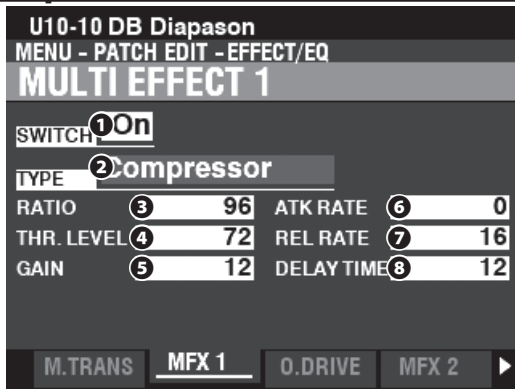

Compressor Structure

Compressor detects the volume of the source, and reduces or emphasizes the amount of volume change.

3 RATIO (REDUCTION RATIO)

Setting Range: 0 ~ 127 (1:1 ~ ∞:1)

This allows you to adjust the rate at which the volume changes between input and output.

A higher value results in a lesser change of volume.

4 THR. LEVEL (THRESHOLD LEVEL)

Setting Range: 0 ~ 127 (-24 ~ ±0 [dB])

This allows you to adjust the value of the input level at which reduction begins.

A lower value results in compression beginning at a lower input level.

5 GAIN (MAKE UP GAIN)

Setting Range: 0 ~ 127 (0 ~ +24 [dB])

This allows you to increase the volume to a level to be reduced by the compression process.

A higher value results in a higher volume.

6 ATK RATE (ATTACK RATE)

Setting Range: 0 ~ 127

This allows you to adjust the rate at which the volume is reduced when the input sound exceeds the threshold level.

A higher value results in a slower reduction rate and the Attack of the sound is emphasized.

7 REL RATE (RELEASE RATE)

Setting Range: 0 ~ 127

This allows you to adjust the rate at which the volume is returned when the input sound is lower than the threshold level.

A higher value results in a slower release time and the Return gain is delayed.

8 DELAY TIME

Setting Range: 0 ~ 127 (0 ~ 40[ms])

This allows you to adjust the “lookahead” time.

A higher value results in a longer lookahead time and as a result a longer delay before the output sound is heard.

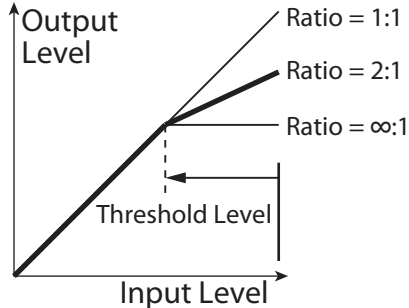

Compressor Concept

tips WHAT IS “LOOKAHEAD?”

“Lookahead” is a special feature of digital compression systems whereby the system can “look ahead” to see the signal before it is processed, identify any possible problems (such as spikes, etc.) and apply any needed correction before Attack, Release and other Parameters are applied. The illustration at the top shows this.

OVERDRIVE

Shortcut: Press and Hold the OVERDRIVE [ON] button.
[SHIFT] + OVERDRIVE [DEPTH] knob

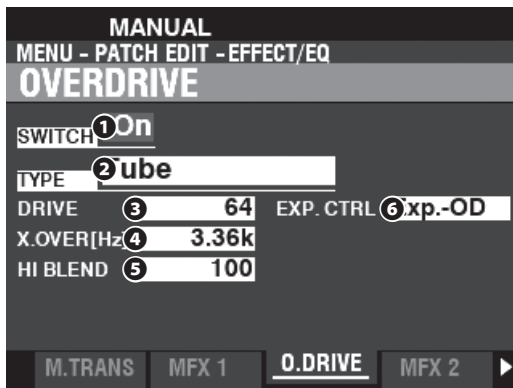

OVERDRIVE adds distortion to the sound by increasing the pre-amplifier input gain.

NOTE: The OVERDRIVE [ON] button must be “ON” in order to hear the Overdrive effect.

NOTE: The Overdrive is placed between Multi Effect “1” and Multi Effect “2.”

1 SWITCH

Settings: Off, On

This allows you to turn Overdrive “ON” or “OFF.”

NOTE: This parameter is linked with the OVERDRIVE [ON] button on the Control Panel.

2 TYPE

This allows you to adjust the character of the Overdrive.

Tube Soft clipped sound similar to a vacuum tube (valve) amplifier.

Solid Hard clipped sound similar to a solid state amplifier.

Clip Precision hard-clipped sound.

EP Amp Soft clipped sound similar to the amplifier of an Electric Piano.

3 DRIVE

Setting Range: 0 ~ 127

This allows you to adjust the amount of the distortion.

A higher value results in more distortion.

This parameter is linked with the OVERDRIVE [DEPTH] knob on the Control Panel.

4 X. OVER (CROSSOVER FREQUENCY)

Setting Range: 400 ~ 14.7k [Hz]

This allows you to adjust the upper limit of the frequency range receiving Overdrive.

A lower value will result in only the frequency range below the Crossover Frequency receiving Overdrive.

5 HI BLEND

Setting Range: 0 ~ 127

This allows you to adjust the volume for “clean” high frequency notes.

NOTE: The mixing rate may not always be “1:1” if the value is set at 64 due to different envelopes between dry and Overdriven sounds.

6 EXP. CTRL (EXPRESSION CONTROL)

This allows you to select how the Overdrive will be affected by the Expression Pedal.

EX-OD Both volume and distortion will be changed by the Expression.

OD-EX Only volume will be changed by the Expression.

OD Only Only distortion will be changed by the Expression.

Input Similar to OD ONLY, but with a smaller amount of change.

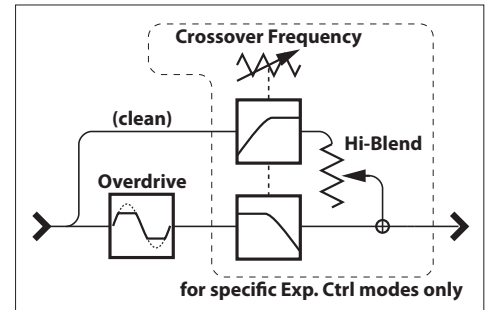

Overdrive Structure

tips CROSSOVER FREQUENCY

In addition to distortion, the Overdrive effect also introduces harmonics (overtones) into the sound. Some of these harmonics may be undesirable and create harmonic interference between dry and overdriven sounds.

By using the Crossover Frequency Parameter to limit the amount of upper frequencies receiving Overdrive, you can minimize or eliminate harmonic interference and create a more pleasing sound.

NOTE: The Parameters described on this spread are Patch Parameters and can be Recorded to individual Patches. For a complete listing of all Patch Parameters, please consult “PATCH PARAMETERS” (P. 152).

MULTI EFFECT 2

App. Menu: PLAY - [≡] - EDIT MULTI EFFECT 2 - [ENTER]

Multi Effect 2 contains the effects listed below and are placed after the Expression or Overdrive effect (P. 34).

1. Auto Pan

Auto Pan smoothly shifts the sound back and forth between Left and Right channels.

2. Phaser

Phaser will create the effect of splitting an audio signal into two paths and varying their phase relationship to each other, resulting in an alternately hollow and full-bodied sound. It can be described as a “swooshing” or “twisting” effect.

3. Flanger

Flanging occurs when two identical signals are mixed together, and one of the signals is time-delayed by a very small amount.

4. Chorus

Chorus refers to a shimmering, non-periodic enhancement of the sound. It is intended to be similar to several instruments sounding in unison, and is helpful when a thicker tonal texture is desired.

5. Delay

Delay adds echo effects.

MULTI EFFECT 2

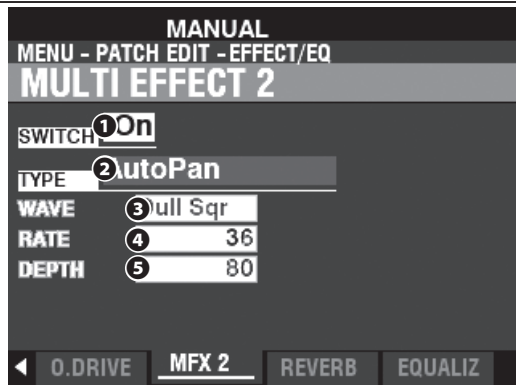

1 SWITCH

Settings: Off, On

This allows you to turn a MULTI EFFECT 2 “ON” or “OFF”

2 TYPE

Setting Range: Auto Pan, Phaser, Flanger, Chorus, Delay

This allows you to select a Multi Effect.

Each Multi Effect has different Parameters. This is explained starting at the right column.

Auto Pan

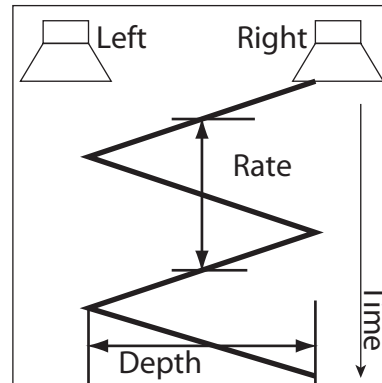

Auto Pan smoothly shifts the sound back and forth between Left and Right channels.

NOTE: This Parameter is not applicable if a monophonic (single channel) sound system is used or a Leslie Speaker Cabinet is connected.

3 WAVEFORM

Settings: Triangle, Square, L to R, S & H, Dull Sqr

This allows you to select the waveform which will modulate the selected sound.

Triangle Triangle wave.

Square Square wave.

L to R Left to Right.

S & H Sample and Hold.

Dull Sqr Dull Square wave.

4 RATE

Setting Range: 0 ~ 127

This allows you to adjust the rate of the modulation.

A higher value results in a faster rate.

5 DEPTH

Setting Range: 0 ~ 127

This allows you to adjust the depth of the modulation.

At “0” there is zero panning. A higher value results in wider panning.

Phaser

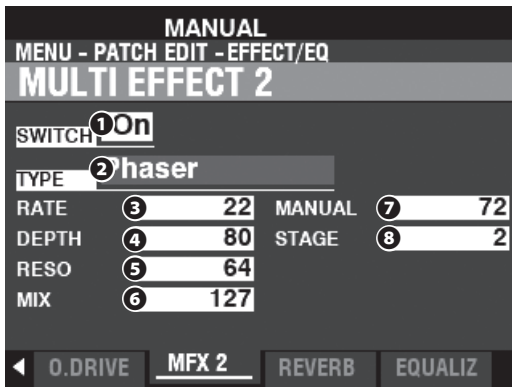
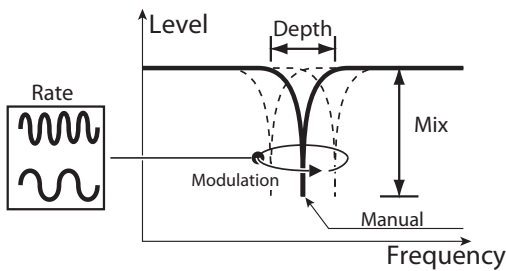

Phaser will create the effect of splitting an audio signal into two paths and varying their phase relationship to each other, resulting in an alternately hollow and full-bodied sound. It can be described as a “swooshing” or “twisting” effect.

- ③ **RATE**
Setting Range: 0 ~ 127
 This allows you to adjust the frequency rate.
 A higher value results in a faster rate.
- ④ **DEPTH**
Setting Range: 0 ~ 127
 This allows you to adjust the depth of the modulation.
 A higher value results in a deeper modulation.
- ⑤ **RESO (RESONANCE)**
Setting Range: 0 ~ 127
 This allows you to adjust the resonance (feed-back) amount.
 A higher value results in a greater resonance.
- ⑥ **MIX**
Setting Range: 0 ~ 127
 This allows you to adjust the volume balance between the “dry” and the effect sounds.
 At “0” only the “dry” sound is heard - the effect level becomes greater as the value increases. At “127” the ratio between the “dry” and the effect sounds becomes 1:1.
- ⑦ **MANUAL**
Setting Range: 0 ~ 127
 This allows you to select the middle frequency of the phase effect.
 A higher value results in a higher frequency.
- ⑧ **STAGE**
Setting Range: 2, 4, 6, 8, 10
 This allows you to adjust the complexity or “stage” of the phasing.
 A higher value creates more complex effects.

Flanger

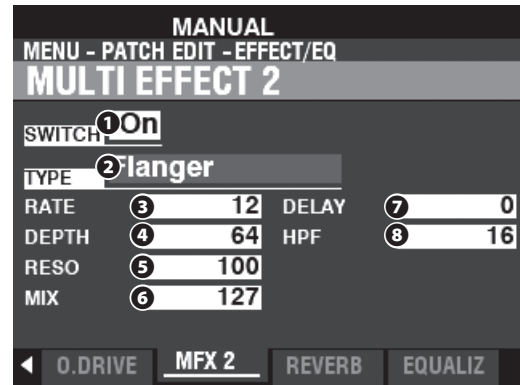
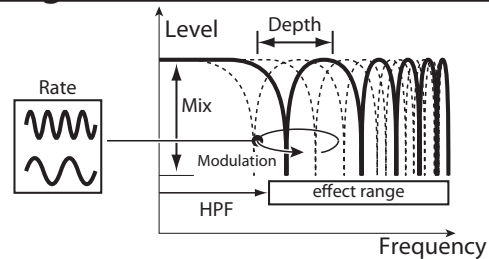

Flanging occurs when two identical signals are mixed together, and one of the signals is time-delayed by a very small amount.

- ③ **RATE**
Setting Range: 0 ~ 127
 This allows you to adjust the modulation rate.
 A higher value results in a faster rate.
- ④ **DEPTH**
Setting Range: 0 ~ 127
 This allows you to adjust the depth of the modulation.
 A higher value results in a deeper modulation.
- ⑤ **RESO (RESONANCE)**
Setting Range: 0 ~ 127
 This allows you to adjust the resonance (feed-back) amount.
 A higher value results in a greater resonance.
- ⑦ **MIX**
Setting Range: 0 ~ 127
 This allows you to adjust the volume balance between the “dry” and the effect sounds.
 At “0” only the “dry” sound is heard. The effect level becomes greater as the value increases. At “127” the ratio between the “dry” and the effect sounds becomes 1:1.
- ⑥ **DELAY**
Setting Range: 0 ~ 127
 This allows you to control the delay of the Flanger effect.
 A higher value results in a longer delay.
- ⑧ **HPF (High Pass Filter)**
Setting Range: 0 ~ 127
 This allows you to control the frequency range of the Flanger effect.
 At “0” the effect is added to all frequencies. The effect is added to the higher frequencies as the value increases.

Chorus

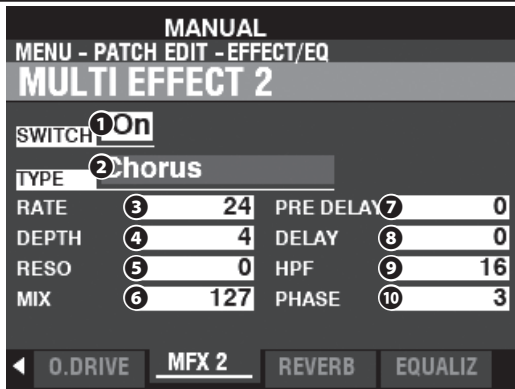

Chorus refers to a shimmering, non-periodic enhancement of the sound. It is intended to be similar to several instruments sounding in unison, and is helpful when a thicker tonal texture is desired.

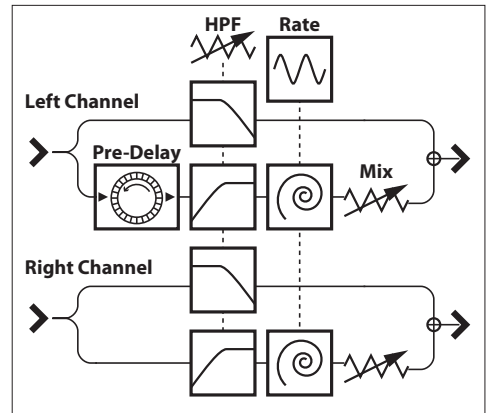

Chorus Structure

3 RATE

Setting Range: 0 ~ 127

This allows you to adjust the rate of the rising and falling effect. A higher value results in a faster rate.

4 DEPTH

Setting Range: 0 ~ 127

This allows you to adjust the modulation depth. A higher value results in a deeper modulation.

5 RESO (RESONANCE)

Setting Range: 0 ~ 127

This allows you to adjust the resonance (feed-back) amount. A higher value results in a greater resonance.

6 MIX

Setting Range: 0 ~ 127

This allows you to adjust the volume balance between the “dry” and the effect sounds. At “0” only the “dry” sound is heard. The effect level becomes greater as the value increases. At “127” the ratio between the “dry” and the effect sounds becomes 1:1.

7 PRE-DELAY

Setting Range: 0 ~ 127

This allows you to delay the signal to the Chorus effect for a channel even if the source is Monaural. A higher value creates a time difference between the Left and Right sound sources.

8 DELAY

Setting Range: 0 ~ 127

This allows you to control the delay of the Chorus effect. A higher value results in a greater delay.

9 HPF (High Pass Filter)

Setting Range: 0 ~ 127

This allows you to control the frequency range of the Chorus effect. At “0” the effect is added to all frequencies. The effect is added to the higher frequencies as the value increases.

10 PHASE

Settings: 2, 3

This allows you to select the algorithm of the Chorus effect.

2 two-phase.

3 three-phase.

Delay

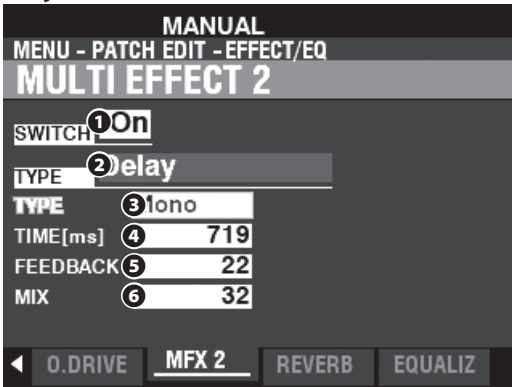

Delay adds echo effects.

3 TYPE

Settings: Mono, RtoL, LtoR

This allows you to select how sounds are reflected.

Mono A simple monophonic "echo."

RtoL, LtoR..... The delay is alternated in the stereo field. At "RtoL" the delayed sound comes from the right. At "LtoR" the delayed sound comes from the left.

NOTE: This is not applicable if a monophonic (single channel) sound system is used or a Leslie Speaker Cabinet is connected.

4 TIME

Setting Range: 10 ~ 1000 [ms]

This allows you to adjust the delay time.

A higher value results in a longer delay time

5 FEEDBACK

Setting Range: 0 ~ 127

This allows you to adjust the number of repetitions of the effect sound.

A higher value results in a greater number of repetitions.

6 MIX

Setting Range: 0 ~ 127

This allows you to adjust the volume balance between the "dry" and the effect sounds.

At "0" only the "dry" sound is heard. The effect level becomes greater as the value increases. At "64" the ratio between the "dry" and the effect sounds becomes 1:1. At "127," only the effect sound is heard.

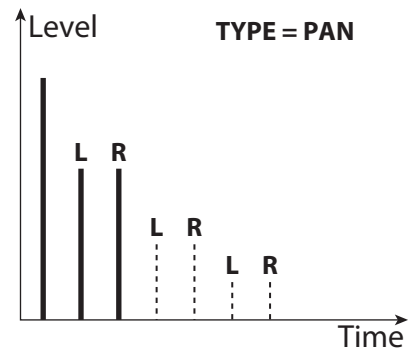
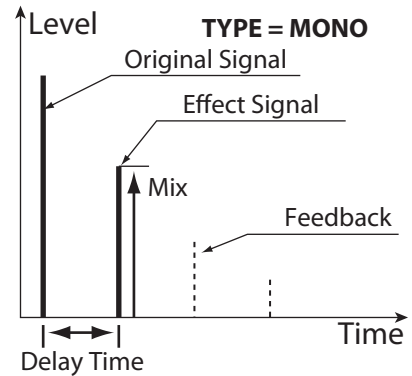

REVERB

Shortcut: Press and Hold the REVERB [ON] button.
[SHIFT] + REVERB [DEPTH] knob

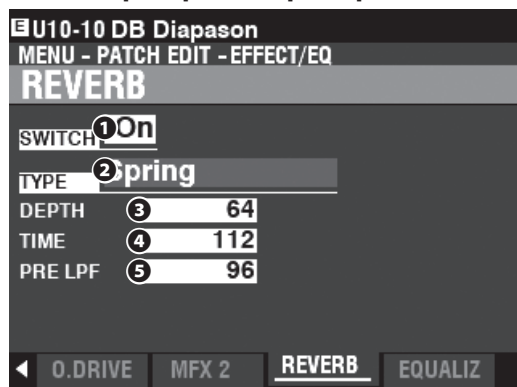

This Page allows you to select the overall REVERB effect.

1 SWITCH

Settings: Off, On

This allows you to turn REVERB “ON” or “OFF.”

NOTE: This Parameter is linked to the REVERB [ON] button on the Control Panel.

2 TYPE

This allows you to select Reverb Types.

Room 1 Large room.

Room 2 Small room.

Live Ambient room.

Hall 1 Dark Hall, similar to a theatre.

Hall 2 Bright Hall, similar to an auditorium.

Church Church.

Plate Iron-plate Reverb.

Spring Spring Reverb.

3 DEPTH

Setting Range: 0 ~ 127

This allows you to select the overall depth of the entire Reverb effect.

NOTE: This Parameter is linked to the [REVERB DEPTH] knob on the Control Panel.

4 TIME

Setting Range: 0 ~ 127

This allows you to adjust the decay of the Reverb.

A higher value results in a longer decay.

NOTE: You can select different Reverb Times for the ORGAN and PIANO/ENSEMBLE/MONO SYNTH Sections.

5 PRE-LPF

Setting Range: 0 ~ 127

This allows you to adjust the tone quality of the Reverb.

Higher values simulate a harder floor/wall/ceiling material.

PATCH EQUALIZER

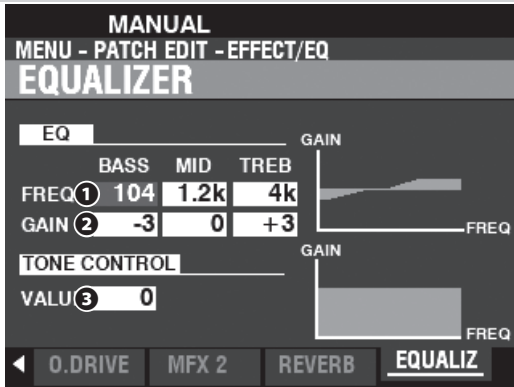

This Page allows you to adjust the Equalization of the sound for each individual Patch.

EQUALIZER

TW	Vx.	Farf	Ace	Pipe
✓	✓	✓	✓	✓

1 FREQ (FREQUENCY)

Setting Range: 20 ~ 308 [Hz] (BASS)
 250 ~ 3.1k [Hz] (MID)
 3k ~ 8k [Hz] (TREB)

These allow you to adjust the center or “turnover” frequency to be attenuated for BASS, MID and TREBLE respectively.

2 GAIN

Setting Range: -9 ~ ±0 ~ +9 [dB]

These allow you to adjust the Boost/Cut of BASS, MID and TREBLE respectively.

NOTE: At “0” the frequency response is “flat.”

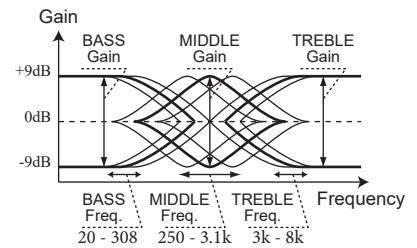

TONE CONTROL

TW	Vx.	Farf	Ace	Pipe
✓	✓	✓	✓	✓

3 VALUE

Setting Range: -9 ~ ±0 ~ +9 [dB]

This Parameter duplicates the performance of the tone control on the AO-28 preamp of a B-3/C-3. Its response is unique, to cut the overall treble above 200Hz gently.

NOTE: The tone control on the B-3/C-3 preamp had “minus” settings only; however, this Parameter provides “plus” settings in addition to “minus” settings.

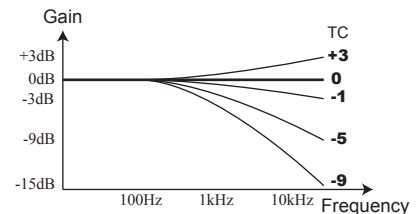

NOTE: The sound may distort if gains are raised too high. Adjust accordingly.

NOTE: The Parameters described on these pages are Patch Parameters and can be Recorded to individual Patches. For a complete listing of all Patch Parameters, please consult “PATCH PARAMETERS” (P. 152).

CONTROLLER

This FUNCTION Mode allows you to select how the [PITCH BEND] and [MODULATION] Wheels and a Damper Pedal will work within a Patch.

To locate this mode:

[MENU/EXIT] - **PATCH - CONTROLLER** - [ENTER]

App. Menu: PLAY - [≡] - **EDIT CONTROLLER** - [ENTER]

Shortcut: [SHIFT] + [PITCH BEND], [MODULATION]

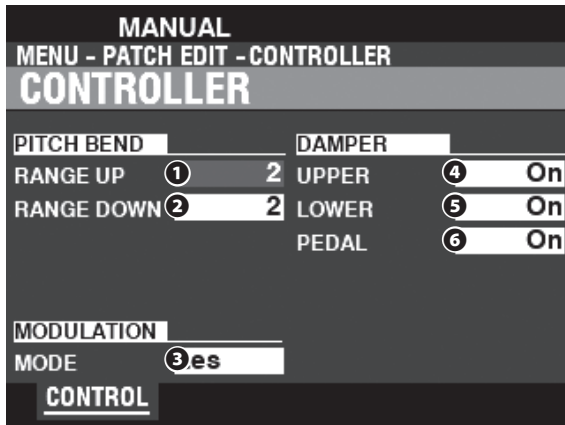

PITCH BEND

① RANGE UP

Setting Range: 0 - 12 [semitones]

② RANGE DOWN

Setting Range: 0 - 24 [semitones]

These allow you to adjust the number of semitones the pitch of the selected Patch will bend “Up” or “Down” using the [PITCH BEND] wheel.

MODULATION

③ MODE

This allows you to select the function of the [MODULATION] wheel.

Off No function.

OD Overdrive Level.

MFx1 Amount of the Multi Effect 1.

MFx2 Amount of the Multi Effect 2.

Les Speed of the Digital Leslie between Slow and Fast.

DAMPER

④ UPPER

⑤ LOWER

⑥ PEDAL

Settings: Off, On

These switches allow you to select on which Parts the notes will be “damped” or held using a connected Damper Pedal.

tips

MULTI EFFECTS CONTROLLED BY THE MODULATION WHEEL

Tremolo: Rate

Wah-Wah: Frequency (Manual), Sensitivity (Exp, Input), LFO Rate (LFO)

Ring Modulator: Frequency (Manual, Exp, Note), LFO Rate (LFO),

Compressor: Threshold Level

Auto Pan: Rate

Phaser: Rate

Flanger: Rate

Chorus: Rate

Delay: Time

This FUNCTION Mode allows you to assign various functions to the ASSIGN [1]/[2] knobs and buttons.

To locate this mode:

[MENU/EXIT] - PATCH - ASSIGN - [ENTER]

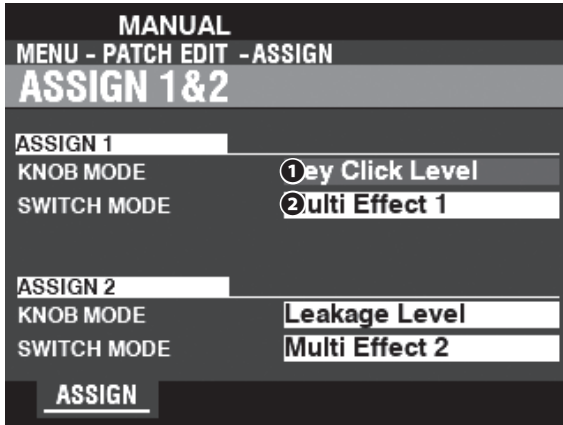

ASSIGN 1/2

1 KNOB MODE

This allows you to assign functions to the ASSIGN [1]/[2] knobs.

- Off** No function assigned.
- MFX1/2 Amount** Adjusts the amount of the selected MULTI EFFECT 1 or 2.
- Leakage Level** Adjusts the Leakage Level for the TW Organ Type (P. 68).
- Key Click Level** Adjusts the Key Click Level for the TW Organ Type (P. 68).
- V. Multi Con. Depth** Adjusts the effect depth of the Virtual Multi-Contacts for the TW Organ Type (P. 70).
- TR Vibrato Rate** Adjusts the Vibrato Rate for the Transistor (Vx, Farf, Ace) Organ Type (P. 72).
- Tremulant Rate** Adjusts the Tremulant Rate for the Pipe Organ Type (P. 72).
- Tone Control Value** Adjusts the Tone Control for the TW and Transistor (Vx, Farf, Ace) Organ Type (P. 85).
- Ext Zone 1/2/3 Volume** Controls the Volume for the selected External Zone (P. 89).
- Ext Zone 1/2/3 Pan** Controls the Pan for the selected External Zone (P. 89).
- Upper Sustain Length** Adjusts the Sustain Length for the UPPER Part (P. 70).
- Lower Sustain Length** Adjusts the Sustain Length for the LOWER Part (P. 70).

2 SWITCH MODE

This allows you to assign functions to the ASSIGN [1]/[2] buttons.

- Off** No function assigned.
- Upper Sustain** Turns Upper Sustain "ON" or "OFF" (P. 70).
- Lower Sustain** Turns Upper Sustain "ON" or "OFF" (P. 70).
- Tone Wheel Brake** Allows you to bend the pitch, with the amount being determined by a Parameter setting (P. 111).
- Spring** Allows you to produce the effect of a Spring Reverb unit being jostled.
- MFX2 Delay Time** Allows you to set the time for the Delay MULTI EFFECT 2 by touching the button repeatedly. Pressing and Holding the button will silence the Delay effect (P. 83).
- Multi Effect 1/2** Turns the selected MULTI EFFECT "ON" or "OFF" (P.75).
- Ext Zone 1/2/3** Enables or disables MIDI transmission for the selected External Zone (P. 89).

tips MULTI EFFECTS CONTROLLED BY THE ASSIGN [1]/[2] KNOBS

- Tremolo:** Rate
- Wah-Wah:** Frequency (Manual), Sensitivity (Exp, Input), LFO Rate (LFO)
- Ring Modulator:** Frequency (Manual, Exp, Note), LFO Rate (LFO),
- Compressor:** Threshold Level
- Auto Pan:** Rate
- Phaser:** Rate
- Flanger:** Rate
- Chorus:** Rate
- Delay:** Time

tips SHORTCUTS FOR ASSIGN [1]/[2] BUTTONS OR ASSIGN [1]/[2] KNOBS

Pressing and Holding any ASSIGN button or turning any ASSIGN knob while holding the [SHIFT] button will "shortcut" to the related function page on the display.

NOTE: The Parameters described on these pages are Patch Parameters and can be Recorded to individual Patches. For a complete listing of all Patch Parameters, please consult "PATCH PARAMETERS" (P. 152).

INTERNAL ZONE

This FUNCTION Mode allows you to determine how the keyboard will interact with the internal sound engine.

Use this Mode to adjust the Parameters for the SPLIT and PEDAL TO LOWER features.

To locate this mode:

[MENU/EXIT] - **PATCH** - **INTERNAL ZONE** - [ENTER]

Shortcut: [PEDAL TO LOWER], [SPLIT]

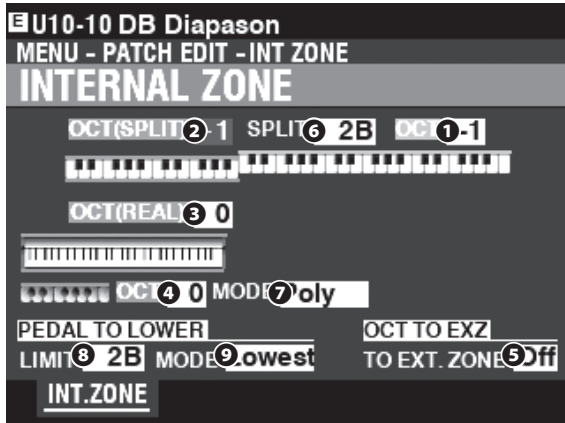

OCTAVE

- ① **OCTAVE (UPPER)**
- ② **OCTAVE (LOWER SPLIT)**
- ③ **OCTAVE (LOWER REAL)**
- ④ **OCTAVE (PEDAL)**

Setting Range: -2 ~ ±0 ~ +2

This allows you to select the Octave or pitch at which the selected Keyboard will sound.

NOTE: These Parameters are linked with the [OCTAVE] buttons on the Control Panel.

There are two LOWER Octave Parameters.

OCTAVE SPLIT ② controls the LOWER Octave setting when the [SPLIT] button (P. 48) is “ON.” OCTAVE REAL ③ controls the LOWER Octave setting when using an expanded keyboard as the LOWER Keyboard (P. 20).

- ⑤ **OCTAVE TO EXTERNAL ZONES**

Settings: Off, On

This allows you to select whether OCTAVE Parameters will be applied to the External Zones (P. 89).

When this Parameter is “ON,” the OCTAVE buttons on the Control Panel can be used to change the Octaves of both the Internal and External Zones.

SPLIT

- ⑥ **SPLIT POINT**

Setting Range: C-2 ~ G8

This allows you to adjust the dividing point between the LOWER Keyboard and UPPER Keyboard.

NOTE: The SPLIT must be active (LED “ON”)

PEDALBOARD

- ⑦ **PEDAL KEY MONO/POLY**

This allows you to adjust whether the PEDALS (P. 21) play single notes (“Mono”) or multiple notes (“Poly”).

Mono If more than one note is played, the lowest note will sound
Poly If more than one note is played, all notes will sound

COUPLER

- ⑧ **PEDAL TO LOWER LIMIT**

Setting Range: -2C ~ 8G

This allows you to adjust the highest note of the LOWER Keyboard if the [PEDAL TO LOWER] feature (P. 49) is “ON.”

- ⑨ **PEDAL TO LOWER MODE**

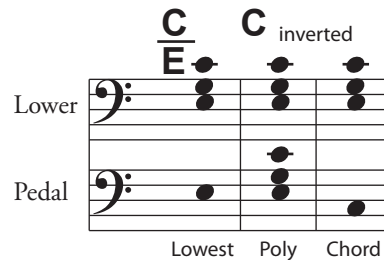

This allows you to select how the PEDAL TO LOWER responds to notes played (see the illustration above).

Lowest Sounds lowest note.

Poly Sounds polyphonic notes.

Chord Sounds the root of the chord.

NOTE: The Parameters described on this page are Patch Parameters, and can be Recorded to a Patch. For a complete list of all Patch Parameters, please see the APPENDIX starting on page 152.

This FUNCTION Mode allows you to configure Zones for controlling external MIDI devices.

To locate this mode:

[MENU/EXIT] - PATCH - EXTERNAL ZONE - [ENTER]

External Zones allow you to control external MIDI equipment either from the XK-4 keyboard or expanded keyboards.

There are three External Zones on the XK-4, each of which can be allocated to UPPER, LOWER or PEDAL Keyboards (P. 126).

NOTE: Using External Zones requires setting the MIDI Parameters properly. This can be done easily using a MIDI Template provided for that purpose. See page 132 for more information about MIDI Templates.

U10-10 DB Diapason						
MENU - PATCH EDIT - EXT ZONE						
EXTERNAL ZONE						
	1 SW	2 CH	3 BNK.M	4 BNK.L	5 PROG	6 ALC
EXT 1	On	1	0	0	1	Upp
EXT 2	On	2	0	0	1	Low
EXT 3	On	3	0	0	1	Ped
INT.UPP						
INT.LOW						
INT.PED						
	7 OCT	8 XPOSE	9 LOW	10 HIGH	11 VOL	12 PAN
EXT 1	0	0	4C	8G	100	-C-
EXT 2	0	0	2F#	3B	127	-C-
EXT 3	0	0	-2C	2F	127	-C-
INT.UPP	0		-2C	3B		
INT.LOW	0		4C	8G		
INT.PED	0		-2C	8G		
	13 VEL	14 DAMP	15 BEND	16 MOD	17 EXP.	18 E.MIN
EXT 1	1	On	On	On	On	40
EXT 2	1	On	On	On	On	40
EXT 3	1	On	On	On	On	40
INT.UPP		On				
INT.LOW		On				
INT.PED		On				
	19 BEND	20 MOD	EXP.	E.MIN	E.MAX	E.CC
EXT 1	On	On	On	40	127	11
EXT 2	On	On	On	40	127	11
EXT 3	On	On	On	40	127	11
INT.UPP						
INT.LOW						
INT.PED						

EXT.ZONE

1 SW (Switch)

Settings: Off, On

This allows you to turn the selected Zone "ON" or "OFF"

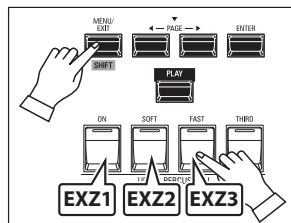

You can allocate External Zones by Pressing and Holding the [SHIFT] button and pressing the UPPER PERCUSSION buttons - [ON] for External Zone 1, [SOFT] for External Zone 2 or [FAST] for External Zone 3 (see the illustration above).

2 CH (MIDI Channel)

Setting Range: 1 ~ 16

This allows you to select the MIDI Channel on which the selected Zone will transmit.

3 BNK.M (Bank MSB)

4 BNK.L (Bank LSB)

Setting Range: 0 ~ 127

5 PROG (Program Change)

Setting Range: 1 ~ 128

This allows you to select the Bank Select and Program Change messages transmitted by the selected Zone.

NOTE: For more specific information about the connected MIDI equipment, please refer to the Owner's Manual for the specific MIDI equipment you are using.

6 ALC (Allocate)

Setting Range: Off, Upper, Lower, Pedal

This allows you to select which Keyboard will control the selected External Zone.

NOTE: "Keyboard" refers to an actual physical keyboard (UPPER, LOWER and PEDAL), not to a SPLIT applied to the Internal Zones.

7 OCT (Octave)

Setting Range: -2 ~ ±0 ~ +2

This allows you to select the Octave or pitch at which the selected External Zone will sound. Adjust this Parameter if an external sound plays in an octave other than the one you need for a particular application.

8 XPOSE (Transpose)

Setting Range: -6 ~ ±0 ~ +6

This allows you to shift the musical key of the selected Zone.

9 LOW (Key Range Low)

10 HIGH (Key Range High)

Setting Range: -2C ~ 8G

This allows you to adjust the UPPER and LOWER note limits for the selected Zone.

U10-10 DB Diapason
MENU - PATCH EDIT - EXT ZONE
EXTERNAL ZONE

	1 SW	2 CH	3 BNK.M	4 BNK.L	5 PROG	6 ALC
EXT 1	On	1	0	0	1	Upp
EXT 2	On	2	0	0	1	Low
EXT 3	On	3	0	0	1	Ped
INT.UPP						
INT.LOW						
INT.PED						
	7 OCT	8 XPOSE	9 LOW	10 HIGH	11 VOL	12 PAN
EXT 1	0	0	4C	8G	100	-C-
EXT 2	0	0	2F#	3B	127	-C-
EXT 3	0	0	-2C	2F	127	-C-
INT.UPP	0		-2C	3B		
INT.LOW	0		4C	8G		
INT.PED	0		-2C	8G		
	13 VEL	14 DAMP	15 BEND	16 MOD	17 EXP.	18 E.MIN
EXT 1	1	On	On	On	On	40
EXT 2	1	On	On	On	On	40
EXT 3	1	On	On	On	On	40
INT.UPP		On				
INT.LOW		On				
INT.PED		On				
	19 BEND	MOD	EXP.	E.MIN	E.MAX	E.CC
EXT 1	On	On	On	40	127	11
EXT 2	On	On	On	40	127	11
EXT 3	On	On	On	40	127	11
INT.UPP						
INT.LOW						
INT.PED						

EXT.ZONE

- 11 **VOL (Volume)**
Setting Range: 0 ~ 127
This allows you to control the Volume (Controller #7) of the sound controlled by the selected Zone.
- 12 **PAN**
Setting Range: L64 ~ C ~ R63
This allows you to adjust the directionality or Pan setting (Controller #10) for the selected Zone.
- 13 **VEL (Velocity Curve)**
Setting Range: Off, 1 ~ 4
This allows you to select how the selected External Zone will respond to key velocity.
“Off” is standard organ touch - the notes play at a fixed velocity (“100”) regardless of a light or heavy key pressure. “1” is the most exaggerated velocity curve while “4” is a gentler curve. “2” and “3” are curves in between.

- 14 **DAMP (Damper)**
- 15 **BEND (Pitch Bend)**
- 16 **MOD (Modulation)**
- 17 **EXP (Expression)**
Settings: On, Off
These allows you to select whether a connected Damper Pedal / [PITCH BEND] Wheel / [MODULATION] Wheel / Expression Pedal will affect the selected Zone.
- 18 **E.MIN (Expression Minimum)**
Setting Range: 0 ~ 63
This allows you to adjust the volume level when the Expression Pedal is “closed” or set at its minimum position. At “0” no sound will be heard.
- 19 **E.MAX (Expression Maximum)**
Setting Range: 64 ~ 127
This allows you to adjust the volume level when the Expression Pedal is all the way “open,” or set at maximum.
- 20 **E.CC (Expression Control Change)**
Setting Range: Off, 7, 11
This selects which message is sent by operating the Expression Pedal. You can select either “VOL” (Volume or Controller #7) or “EXP” (Expression or Controller #11) depending on which Controller Number a connected MIDI device will receive.

MESSAGE ON/OFF

Sometimes when transmitting MIDI messages, undesired information or not enough information may be sent. This can be prevented by switching the appropriate MIDI message “OFF”

MIDI messages which can be switched “OFF” by Patch:
.....Note, Expression, Pitch Bend, Modulation, Damper (in This Page).

System Parameters which can be switched “OFF” individually:
.....Bank Select, Program Change, whole External Zone (see page 132).

PANIC FUNCTION / PARAMETER RELOAD

MIDI plays notes from an external instrument by sending two commands - “Note On” which starts the note playing, and “Note Off” which releases the note and stops it from playing. These two commands are always sent in pairs.

Once in a while, a Note Off command may not follow a Note On command, causing a note or notes to cipher, or sound continuously (the phenomenon popularly referred to a “stuck notes”). In this case, you need to send a MIDI command to the receiving instrument to clear the ciphering notes.

To do this, press the DIRECTION [▲][▼] buttons simultaneously. Doing this will send a “MIDI All Notes Off” as well as a “MIDI Reset All Controllers” command to the receiving instruments. The stuck notes will be turned off and the settings for the External Zones will be reset, then the External Zone settings will be re-sent. Normal playing can then be resumed.

NOTE: The Parameters described on this page are Patch Parameters, and can be Recorded to a Patch. For a complete list of all Patch Parameters, please see the APPENDIX starting on page 152.

After you have created your own setting, you can save it as a User Patch (P. 26).

There are two ways to record a Patch.

1. Using the [VALUE] knob,
2. Using the Number buttons.

USING THE [VALUE] KNOB

① PRESS THE RED [RECORD] BUTTON

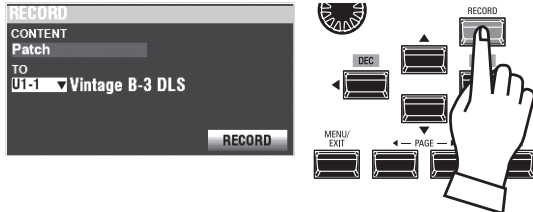

After you have made your changes to a Patch, press the [RECORD] button. The RECORD Page will display.

② SELECT THE ITEM TO RECORD (PATCH)



Use the [VALUE] knob and the DIRECTION buttons to set the CONTENT at "Patch," and the TO at the Patch number you wish to record.

Next, move the cursor on the [RECORD] icon, press the [ENTER] button.

USING THE NUMBER BUTTONS

This procedure is enabled when the FAVORITE Parameter is set to "Off" and ACCESS MODE is set at "(Bank)/Patch." (P. 116)

Example: Record "U5-3" (Bank #5, Number #3).

① SET THE BANK

NOTE: If you are working in the currently selected Bank, you may skip this step.

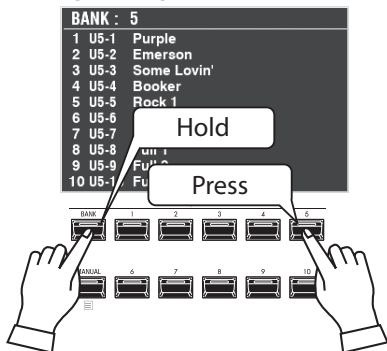

Press and Hold the [BANK] button, and NUMBER button to select the Patch Bank ([5] in this example).

The display shows the list of the Patches in the Bank, and all the NUMBER buttons begins flashing for demand the selecting Number.

② SELECT THE NUMBER

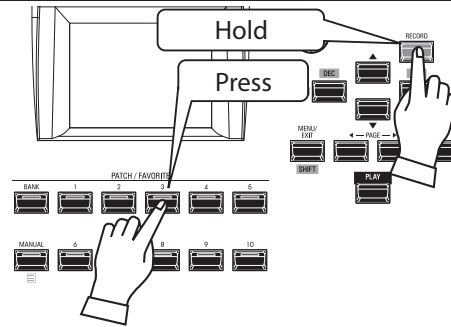

Press and Hold the [RECORD] button, and press any one of the NUMBER buttons ([3] in this example).

NAMING AND RECORDING

③ INPUT THE PATCH NAME

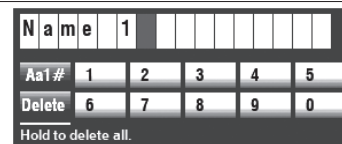

Input the Patch Name.

[BANK]Change the character group.

[MANUAL]Delete a letter.

[1] - [10]Input a letter.

DIRECTION [◀][▶]Move the cursor.

[VALUE] knobChange the letter.

④ RECORD THE PATCH

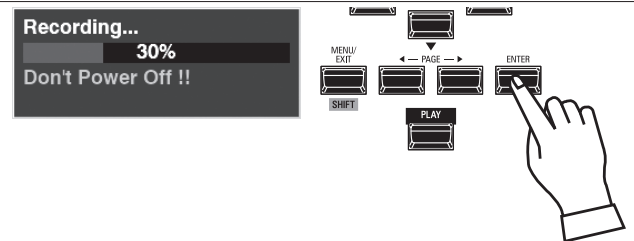

After you are finished Naming, press the [ENTER] button.

NOTE: If you DO NOT wish to Record, press the [MENU/EXIT] or [PLAY] button instead of the [ENTER] button.

The message shown above will display for approximately 1 second.

NOTE: Do not turn the power "OFF" while the above message is displaying.

When the display shows:

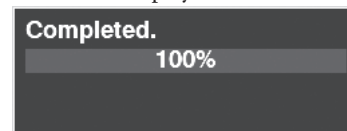

the Recording process is finished and your setting has been Recorded.

APP MENU JOBS

In addition to allowing you to select FUNCTION Mode Pages, the APP (Application) Menu (P. 66) contains special operations called **Jobs**. These are explained starting below.

INITIALIZE PATCH



This Job allows you to initialize all the Parameters for the currently selected Patch.

To Initialize the Patch, press the [ENTER] button. The cursor is fixed at the [INITIALIZE] icon.

NOTE: To cancel the initialize, press the [MENU/EXIT] button.



The message shown above will display for approximately 1 second. When this message disappears, the Patch is Initialized.

REGISTER PAGE TO FAVORITE



This Job allows you to Register the current Page to a [FAVORITE] button. To do this:

1. Use the [VALUE] knob to select the {FAVORITE} button you want to use.
2. Use the [DIRECTION] “▼” button to locate the cursor to the [REGISTER] icon.
3. Press the [ENTER] button.

NOTE: If you DO NOT wish to Register, press the [MENU/EXIT] or [PLAY] button instead of the [ENTER] button.

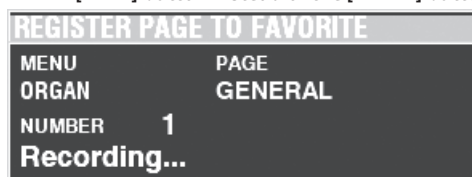

The message shown above will display for approximately 1 second:

When the display shows:

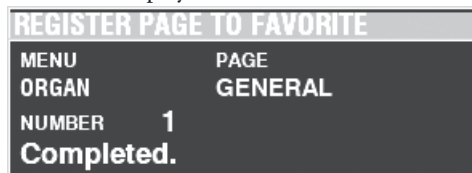

The selected Page has been Registered to the [FAVORITE] button you selected.

NOTE: To locate an registered Page, Press and Hold the [SHIFT] button and press a Number button (P. 117).

The XK-4 allows you to Record certain Parameters into macro-settings called **Custom Tone Wheels**, **Custom Pipes**, **Custom Pedal Registrations** and **Custom Leslie Cabinets**. In this way you can include multiple Parameter settings as part of a Patch, and include the same settings in multiple Patches.

CUSTOM CONTENTS

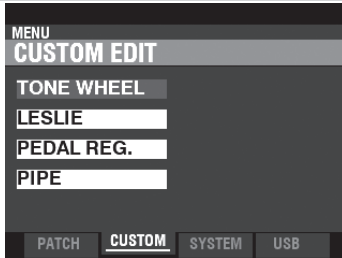

CUSTOM TONE WHEEL (P. 94)

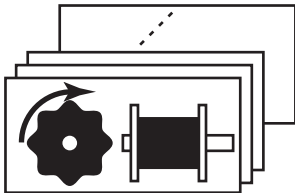

This allows you to select or create Custom Tone Wheels. A Custom Tone Wheel includes profiles of specific organs, Drawbar Foldback points, levels of each individual Tone Wheel, etc.

CUSTOM PEDAL REGISTRATION (P. 99)

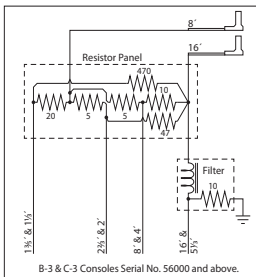

This allows you to select and create Custom Pedal Registrations (registrations for the Pedal Drawbars).

CUSTOM LESLIE (P. 100)

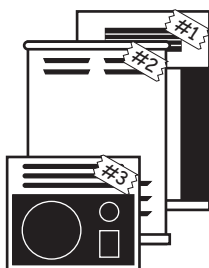

This allows you to select or create Custom Leslie Cabinets.

CUSTOM PIPE (P. 102)

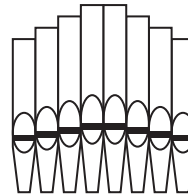

This allows you to select or create Custom Pipes. A Custom Pipe includes assignment of Pipe Voices to the Drawbars as well as Volume settings, Chiff settings, etc.

◆ WHAT IS THIS DIALOG BOX?

If you select an ORGAN Type other than the one currently selected, a dialog box similar to the one shown below will display:

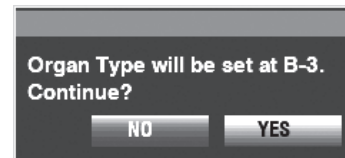

If you want to change the ORGAN Type, use the DIRECTION [▶] button to move the cursor to the [YES] icon, and press the [ENTER] button. If you select [NO] the previous screen will appear.

◆ RECORD THE CUSTOM CONTENTS (P. 104)

None of the Custom Parameter settings will be remembered unless they are Recorded in one of the Custom units.

NOTE: User ("U") Custom settings come from the factory pre-programmed with the same settings as the Factory ("F") settings.

APP (APPLICATION) MENU

The APP (Application) Menu allows you to select certain FUNCTION Mode Pages or to perform special operations called **Jobs**.

1. Select one of the Custom Settings to edit.
2. Press and Release the [≡] button. The Menu option shown below will display:

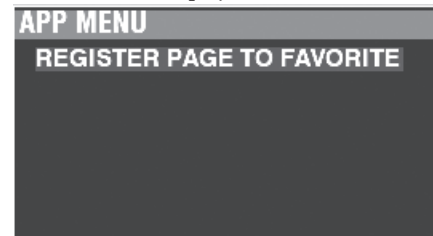

REGISTER PAGE TO FAVORITE

..... Register the current Page to a Favorite.

Press the [ENTER] button to select the displayed option.

CUSTOM TONE WHEELS

This FUNCTION Mode allows you select or edit the characteristics of the Tone Wheel Organ.

The Parameters described on these pages are grouped in macro-settings called **Custom Tone Wheels**. These Parameters cannot be Recorded as individual Patch Parameters; however, a Custom Tone Wheel can be Recorded as part of a Patch.

To locate this mode:

[MENU/EXIT] - CUSTOM - TONE WHEELS - [ENTER]

SET

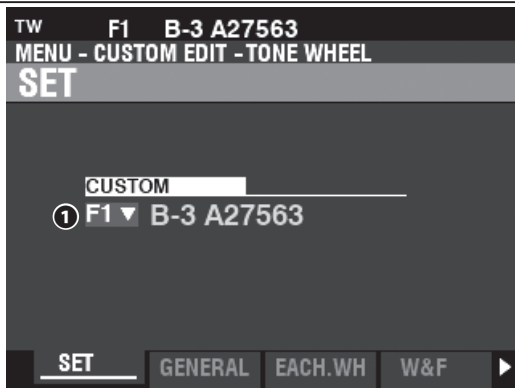

1 CUSTOM SET (P)

Setting Range: F1 ~ F4, U1 ~ U4

This allows you to select the Custom Number to edit. The letter “F” means Factory (non-re-writable) and “U” means User (re-writable).

GENERAL

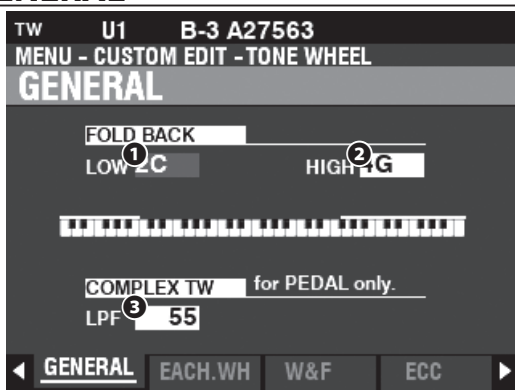

1 LOW (TW)

Setting Range: 1C ~ 2C

This allows you to adjust the key-point from which the Drawbar pitches for the Sub-Fundamental (16') Drawbar “Fold Back” (repeat the pitches played by other notes) on the lower octave of the keyboard.

The bottom key on the keyboard is displayed as “1C.”

2 HIGH (TW)

Setting Range: 4G ~ 5C

This allows you to adjust the key-point at which the 1' Drawbar pitches “Fold Back” (repeat the pitches played by other notes) in the higher octaves of the keyboard.

NOTE: The FOLD BACK effect will be heard starting with the 2½' Drawbar (first black Drawbar) and all the other Drawbars which introduce high harmonics.

3 LPF (TW)

Setting Range: 0 ~ 127

This allows you to adjust the brightness of the Complex Tone Wheels used for PEDAL pitches #01 to #12. A higher value produces a brighter tone.

tips WHAT ARE “CUSTOM TONE WHEELS?”

When the Tone Wheel Hammond Organs - B-models, C-models, A-100, etc. - were being manufactured, each individual organ was subjected to a rigorous series of checks and tests to insure the quality of each unit, and to insure that all the units representing a particular model series sounded alike. However, since the very newest B-3-type organ is almost 50 years old, vintage organs are dependent for their sound on analog components. Several factors may affect the sound of a particular unit. Thus, a B-3 manufactured in 1959 may well have a slightly different tone than one made in 1969, not necessarily because of the year but because of slight differences in component values among other factors. Also, many characteristics of the Hammond Organ, especially as heard in much jazz and rock music, have to do with the overall condition of the instrument. The Custom Tone Wheel feature is included to allow you to find, or create the nearest approximation of what you want your “Hammond Sound” to be.

tips FOLD BACK

On the earliest model Hammond Organs, the Sub-Fundamental Drawbar (the one marked, “16”) would continue to play all the way down to the lowest “C” (“1C”). Newer models such as the Hammond Models X-66, X-77 and Concorde do the same, however, the 8th harmonic Drawbar (the one marked “1”) continues to play up the keyboard to the next to highest “C” (“5C”) on the Keyboard.

On a vintage B-3/C-3, etc., the lowest note produced by the Sub-Fundamental Drawbar is the 2nd “C” (“2C”) from the left end of the Keyboard, while the highest note that can be played by the 8th harmonic Drawbar is the 4th “F#” from the left end of the Keyboard. The lower and higher keys on the keyboard **Fold Back**, in that they repeat the pitches played by other notes.

tips LPF

A vintage B-3/C-3 has a **Low Pass Filter** (LPF) which attenuates the higher frequencies above the Cutoff Frequency and which is applied to the frequencies generated by the Tone Wheels before they reach the amplifier. The XK-4 replicates this feature.

EACH WHEEL

This Page adjusts the level of the each wheel and its leakage level.

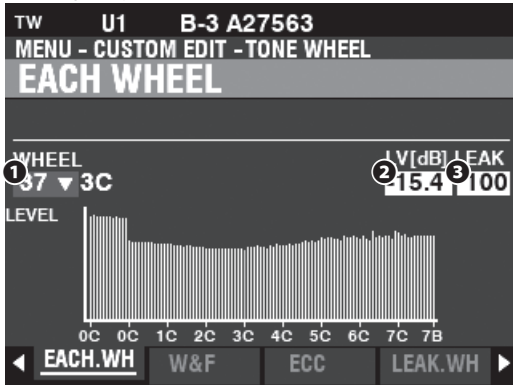

1 WHEEL

This allows you to select the Tone Wheel you want to edit.

The setting range is displayed by “Wheel Number” and “Note.”

- 01: 0C to 12: 0B,
- F01: 0C to F12: 0B,
- 13: 1C to 91: 7F# and
- F92: 7G to F96: 7B.

“F” denotes wheels used for extended “Fold Back.” The non-marked Wheel Numbers indicate original wheels from the B-3/C-3.

There are two ways to select the Wheel Number:

1. Use the [VALUE] knob, or,
2. If you want to locate a certain Tone Wheel quickly, move the Drawbar slightly while depressing the key you want to regulate (see the illustration on the right).

When the Wheel Number is selected, each Parameter for the wheel (2 to 4) is updated.

NOTE: Make sure [TRANSPOSE](P. 51) and [OCTAVE](P. 48) are set at “0” to ensure that the correct Wheel is selected.

2 LEVEL (TW)

Setting Range: -Inf, -60.0 ~ +4.0 [dB]

This allows you to adjust the volume of the selected Wheel.

Press and Hold the [SHIFT] button to make fine adjustments to the Wheel Level while turning the [VALUE] knob.

3 LEAK (TW)

Setting Range: 0 ~ 127

This allows you to adjust the amount of Leakage sound added to the Fundamental sound.

A higher value will result in more Leakage.

NOTE: See page 97 for more information about Leakage.

tips “F” WHEELS AND PEDAL WHEELS

On the B-3/C-3/A-100, there are 91 sounding tone wheels. Wheels #1 through #12 are special wheels called **Complex Wheels** used exclusively for the PEDAL tones. Later Hammond models had 96 sounding tone wheels, with the Sub-Fundamental Drawbar (“16”) continuing to play all the way down to the lowest “C” (“1C”) and 5 additional pitches at the top. On the XK-4, the extended pitches are designated as “F” (Fold Back) pitches (see the illustration below).

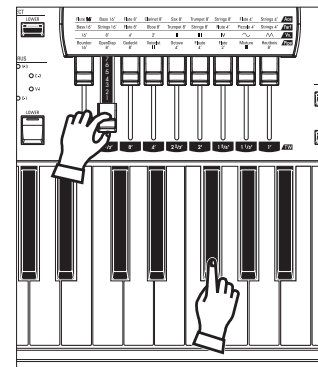
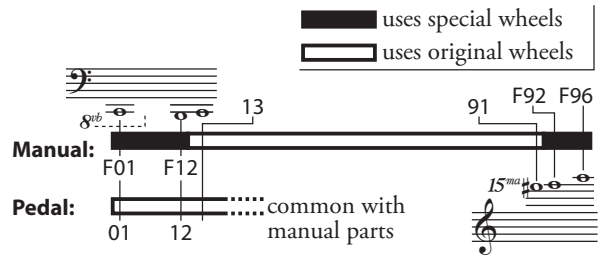

Selecting a WHEEL NUMBER to edit

tips DECIBEL (dB)

A decibel (dB) is a unit for measuring the intensity of a sound. For example, “0dB” is a reference level, “+6dB” doubles the sound intensity and “-6dB” decreases the sound intensity by about 50%.

tips CHANGING STEPS AND THE [SHIFT] BUTTON

For the “dB” parameters in this mode, turning [VALUE] knob changes the value at 0.5[dB] increments.

While holding the [SHIFT] button, the value will be changed at 0.1[dB] increments.

NOTE: The Parameters labeled (TW) are Tone Wheel Parameters. You must Record these Parameters to a Custom Tone Wheel if you want their settings to be remembered the next time the instrument is turned “ON.” See page 104 for instructions on how to do this.

WOW & FLUTTER

This Page allows you to adjust the phase (makes pitch) modulation.

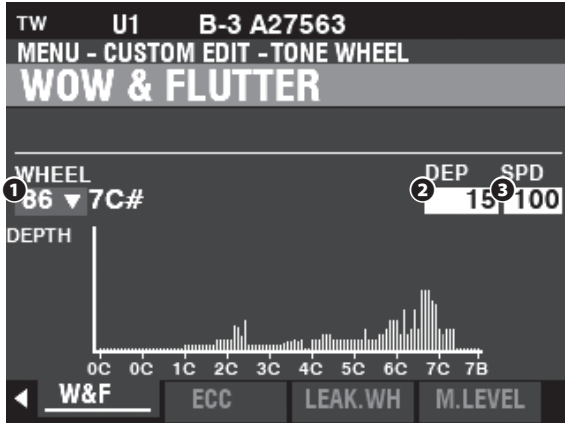

1 WHEEL

This allows you to select the Fundamental Wheel to edit.

NOTE: See EACH WHEEL (page 95) for more detail.

2 DEPTH (TW)

Setting Range: 0 ~ 127

This allows you to adjust the Depth of the effect.

3 SPEED (TW)

Setting Range: 0 ~ 127

This allows you to adjust the Speed of the effect.

tips WOW & FLUTTER

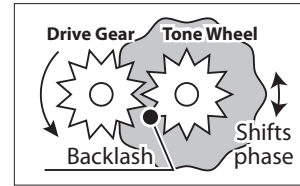

The illustration above shows how Tone Wheels are driven by an arrangement of gears connected to a constant speed motor. Because gears need a certain amount of “play” to keep them from jamming when they mesh, a Tone Wheel may rotate backwards very slightly while turning, resulting in what is known as “backlash.” This will cause the pitch and/or phase to change slightly at a rapid rate. A rapid slight fluctuation of pitch is called “flutter” while “wow” is a slower “once-per-revolution” change of pitch or phase.

The terms “Wow” and “Flutter” have been given very specific definitions by the International Electrotechnical Commission or IEC, the body that establishes standards for electrical and electronic technologies. “Wow” is a cyclical pitch change of under 10Hz while “Flutter” is a more irregular pitch variation over 10Hz. “Wow and flutter” is the generic term for both.

WHEEL ECCENTRICITY

These Parameters allows you to adjust periodic changes in loudness or volume caused by wheel eccentricity (see the illustration on the right).

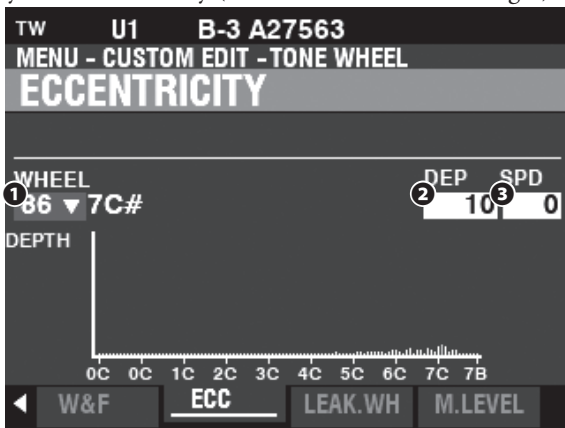

1 WHEEL

This allows you to select the Fundamental Wheel to edit.

NOTE: See EACH WHEEL (page 95) for more detail.

2 DEPTH (TW)

Setting Range: 0 ~ 127

This allows you to adjust the Depth of the effect.

3 SPEED (TW)

Setting Range: 0 ~ 127

This allows you to adjust the Speed of the effect.

tips WHEEL ECCENTRICITY

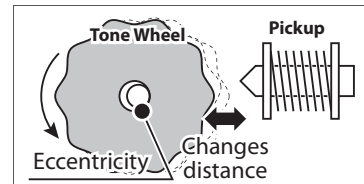

As shown in the illustration above, if a Tone Wheel has been stamped slightly off-center, the high spots on the wheel will move slightly closer or slightly further away with each revolution, resulting in the sound becoming slightly louder and softer. These Parameters recreate this phenomenon.

LEAKAGE WHEEL

This Page allows you to add a Leakage Tone to any of the “Fundamental Wheels.”

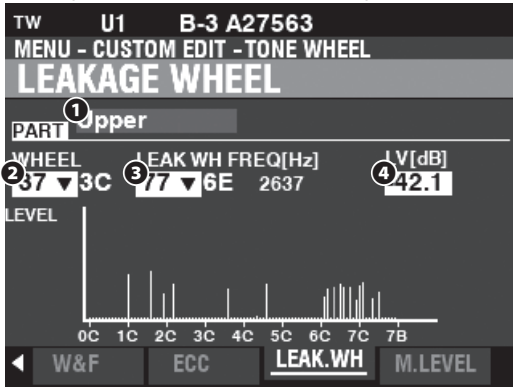

The Wheels from “01:0C to “72:6B” are referred to as “Fundamental Wheels” while the wheels from “61:6C” through “91:8F” are “Leakage Wheels” (see the illustration on the right).

The Leakage Wheel will sound along with the Fundamental Wheel ②.

① PART

Setting Range: Upper, Lower, Percussion, Pedal

This allows you to select the Part to edit.

② WHEEL

Setting Range: F01:0C - 72:6B

This allows you to select the Fundamental Wheel to edit.

NOTE: See EACH WHEEL (page 95) for more detail.

There are two ways to select the Wheel Number:

1. Use the [VALUE] knob, or,
2. If you want to locate a certain Tone Wheel quickly, move the Drawbar slightly while depressing the key you want to regulate (see the illustration on the right).

③ LEAK WH (TW)

Setting Range: F01:0C - 72:6B

This allows you to add a Leakage Tone to any of the Wheels (“Fundamental Wheels”) by using the “Leakage Wheels” (see the illustration on the right).

In addition, the frequency[Hz] is also shown at right side of the Wheel number.

④ LEVEL (TW)

Setting Range: -Inf (OFF), -60.0 ~ +4.0 [dB]

This allows you to adjust the Volume of the selected Leakage Wheel.

Use the [VALUE] knob to adjust the Volume of the selected Leakage Wheel.

Press and Hold the [SHIFT] button to make fine adjustments to this Parameter while turning the [VALUE] knob.

NOTE: The overall volume of the selected Wheel may decrease as the Leakage Volume is increased.

tips WHAT IS “LEAKAGE?”



On a Tone Wheel Hammond Organ, each Tone Wheel rotates next to a magnet, making a total of 91 or 96 magnets. The Tone Wheels are mounted in separate bins to isolate them from each other and prevent the magnets from intercepting frequencies from neighboring wheels; however, a small amount of current may still “leak” through, producing a phenomenon called Leakage. Leakage is usually heard as a “hash” type sound consisting of many frequencies sounding at once. The phenomenon can be thought of as similar to white noise but with somewhat more definition, with individual pitches more discernable. A properly calibrated B-3/C-3 will have a minimum of this effect; However, an instrument which has been subjected to hard use over a period of time may exhibit more leakage noise.

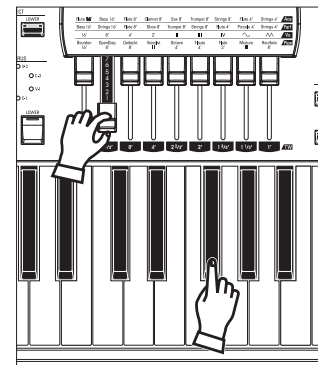
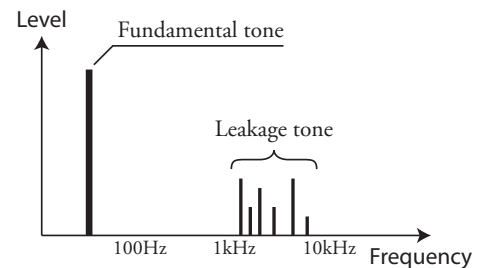

Selecting a WHEEL NUMBER to edit

NOTE: The Parameters labeled (TW) are Tone Wheel Parameters. You must Record these Parameters to a Custom Tone Wheel if you want their settings to be remembered the next time the instrument is turned “ON.” See page 104 for instructions on how to do this.

MATRIX LEVEL

This Page allows you to select a **Matrix** to adjust the volume of each Part, each Drawbar and each Note.

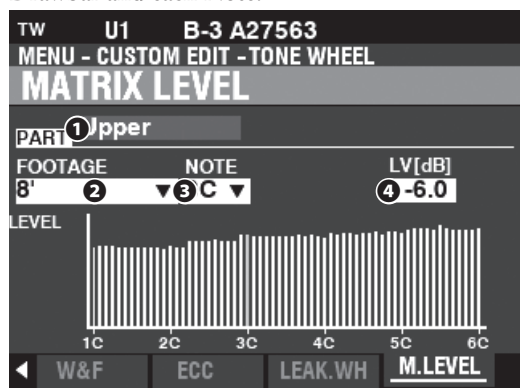

1 PART

Setting Range: Upper, Lower, Percussion, Pedal

This allows you to select the Part to edit.

2 FOOTAGE

Setting Range:

Part	Option
Upper, Lower	16', 5½', 8', 4', 2½', 2', 1¾', 1½', 1'
Percussion	2nd, 3rd
Pedal	Pk16-16', 5½', 8', 4', 2½', 2', 1¾', 1½', Pk8-16', 5½', 8', 4', 2½', 2', 1¾', 1½'

This allows you to select the Footage or Percussion harmonic to edit.

The Footages labeled “Pk...” are the harmonic elements of the PEDAL Drawbars.

3 NOTE

Setting Range: 1C ~ 6C

This allows you to select the Note to edit.

4 LEVEL (TW)

Setting Range: -Inf, -60.0 ~ +4.0 [dB]

This allows you to adjust the volume of the highlighted Note within the Matrix above 1, 2 and 3.

Press and Hold the [SHIFT] button to make fine adjustments to this Parameter while turning the [VALUE] knob.

NOTE: The highlighted Note will be shown as a red line in the bar chart of the display.

tips LEVEL FOR PEDAL

If a Level 4 for PEDAL Footage (Pk16-x, Pk8-x) is set at “0,” that Footage will not sound. Be careful not to set too many of these values at “0” to ensure some sound will be heard when the PEDAL Drawbar containing those Footages is used.

NOTE: The Parameters labeled (TW) are Tone Wheel Parameters. You must Record these Parameters to a Custom Tone Wheel if you want their settings to be remembered the next time the instrument is turned “ON.” See page 104 for instructions on how to do this.

This FUNCTION Mode allows you to select or edit the registrations for the PEDAL or **Sub-Drawbars**.

The Parameters described on this page are grouped in macro-settings called **Custom Pedal Registrations**. These Parameters cannot be Recorded as individual Patch Parameters; however, a Custom Pedal Registration (**PEDAL REG.**) can be Recorded as part of a Patch.

To locate this mode:

[MENU/EXIT] - **CUSTOM - PEDAL REG.** - [ENTER]

The “Sub-Drawbar” is used only on the “TW” ORGAN Type and “Normal” PEDAL Type. When this FUNCTION Mode is located, the ORGAN Type and the PEDAL Type are switched at “TW” and “Normal” automatically.

tips WHAT ARE “SUB-DRAWBARS?”

On a tone-wheel Hammond Organ, the harmonic resources for PEDAL tones are combined into two Drawbars each of which draws a combination of harmonics instead of individual harmonics as with the other Drawbars. Over the years, several different schemes were used to voice the PEDAL Drawbars. These are shown below.

SET

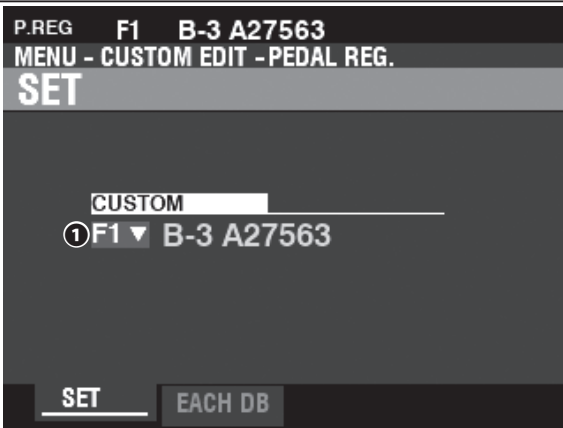

1 CUSTOM SET (P)

Setting Range: F1 ~ F4, U1 ~ U4

This allows you to select the Custom Number to edit.

“F” refers to Factory settings which are permanently stored in memory and cannot be overwritten. “U” or User settings can be modified or even overwritten entirely in order to create your own Custom Pedal Registration.

EACH PEDAL DRAWBAR

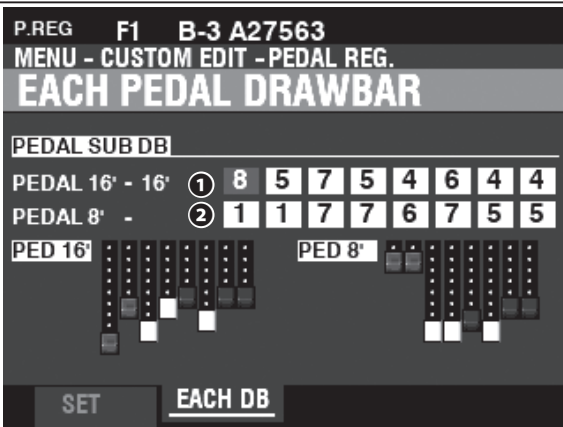

1 SUB DRAWBAR - 16' (PR)

2 SUB DRAWBAR - 8' (PR)

Setting Range: 0 ~ 8

These allow you to adjust the harmonics of each PEDAL Drawbar. Adjustable footages are 16', 5 1/2', 8', 4', 2 1/2', 2', 1 3/4', and 1 1/2'.

NOTE: The footages 2 1/2', 2', 1 3/4' and 1 1/2' in the Sub Drawbar 16' have softer maximum volumes than the other footages for fine-adjustment.

NOTE: The Parameters labeled (PR) are Pedal Registration Parameters. You must Record these Parameters to a Custom Pedal Registration if you want their settings to be remembered the next time the instrument is turned “ON.” See page 104 for instructions on how to do this.

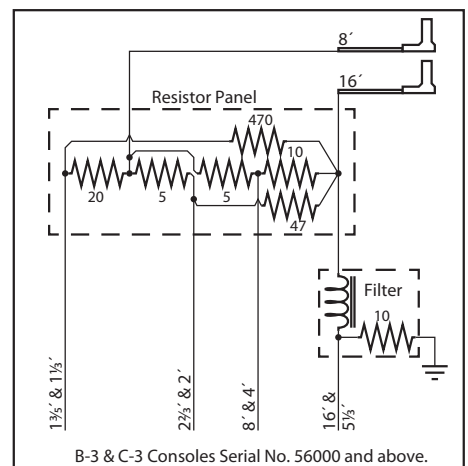
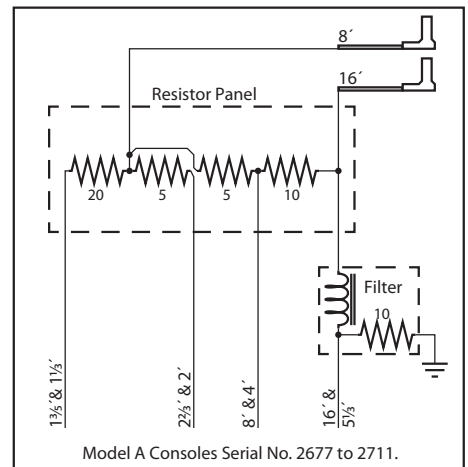
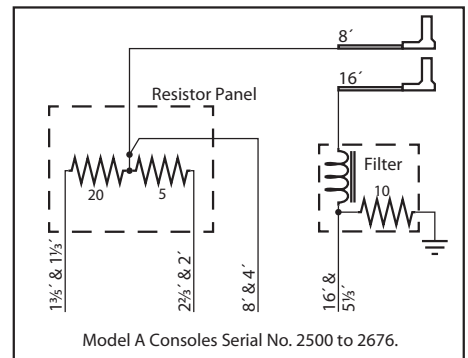

This FUNCTION Mode allows you to select or edit the Parameters for the inbuilt digital Leslie.

The Parameters described on these pages are grouped in macro-settings called **Custom Leslie Cabinets**. These Parameters cannot be Recorded as individual Patch Parameters; however, a Custom Leslie Cabinet can be Recorded as part of a Patch.

To locate this mode:

[MENU/EXIT] - **CUSTOM - LESLIE** - [ENTER]

CABINET NUMBER

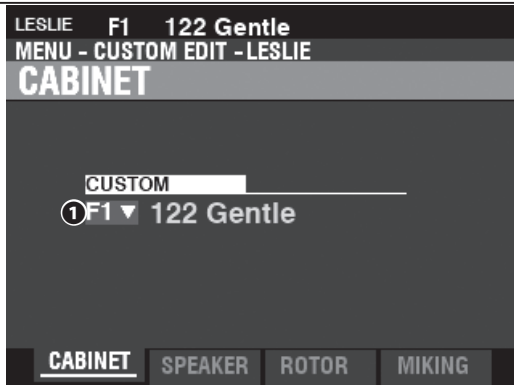

1 CUSTOM CABINET (P)

Setting Range: F1 ~ F8

This allows you to select the Cabinet Number to edit.

The letter “F” stands for Factory (non-re-writable) and “U” stands for User (re-writable).

NOTE: See the APPENDIX on page 155 for more information about Custom Leslie Cabinets.

SPEAKER

1 SPEAKER (L)

Setting Range: L145 Front, L145 Rear, L147 Front, L147 Rear, L122 Front, L122 Rear, Cone Type, PR-40 Type

This allows you to select the Speaker Type and Front and Rear microphone placement.

ROTOR

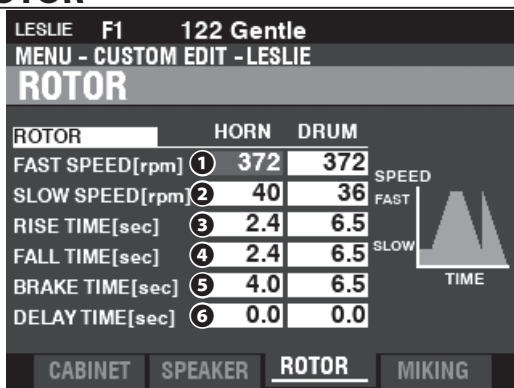

1 SLOW SPEED - HORN / DRUM (L)

Setting Range: 0, 20 ~ 120 [rpm]

These allow you to set the rotor speed for the “SLOW” or Chorale Mode.

tips WHAT ARE “CUSTOM LESLIE CABINETS?”

The XK-4 has 8 different Custom Leslie Cabinets. These are Factory Cabinets (indicated by an “F”) which are permanently written in memory. However, you can create and Record up to 8 User Cabinets (which will be indicated by a “U”).

To create and Record a Leslie Cabinet, use the LESLIE FUNCTION Mode to modify the sonic characteristics of one of either the “F” or “U” Custom Cabinets. After you have made all of your changes, you can Record them as a “U” Leslie Cabinet.

For a list of the Factory Leslie Cabinets consult the APPENDIX at the back of this Manual starting on page 155. For a complete list of Leslie Parameters consult the APPENDIX on page 157.

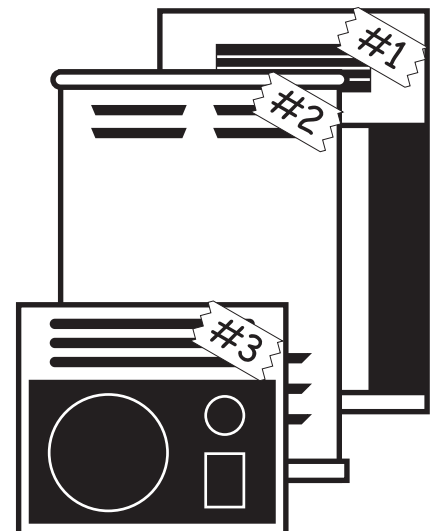

2 FAST SPEED - HORN / DRUM (L)

Setting Range: 0, 200 ~ 500 [rpm]

These allow you to set the rotor speed for the “FAST” or Tremolo Mode.

3 RISE TIME - HORN / DRUM (L)

Setting Range: 0.8 ~ 12.5 [sec] (Horn)
1.0 ~ 12.5 [sec] (Drum)

These allow you to adjust the time for the rotors to “ramp up” to “FAST” Mode when switching from “SLOW” or “STOP” to “FAST” Mode.

4 FALL TIME - HORN / DRUM (L)

Setting Range: 0.8 ~ 12.5 [sec] (Horn)
1.0 ~ 12.5 [sec] (Drum)

These allows you to adjust the time for the rotor to reach the “SLOW” rotor speed when switching from “FAST” to “SLOW” Mode.

5 BRAKE TIME - HORN / DRUM (L)

Setting Range: 0.8 ~ 12.5 [sec] (Horn)
1.0 ~ 12.5 [sec] (Drum)

This allows you to adjust the time for the rotor to Stop when switching from “FAST” to “STOP” Mode.

6 DELAY TIME - HORN / DRUM (L)

Setting Range: 0.0 ~ 1.0 [sec]

These allow you to adjust the time to start changing the speed when the Mode is switched.

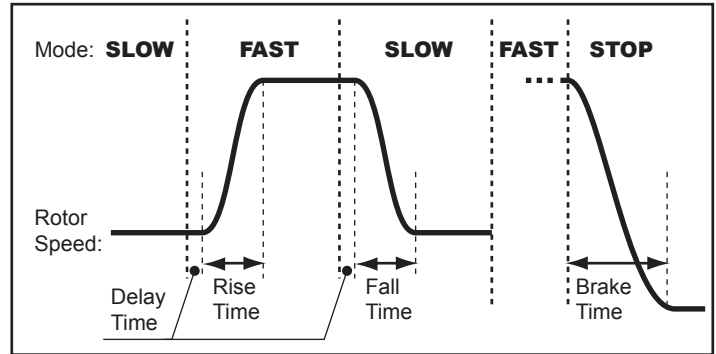

tips WHAT IS “TIME” BASED ON?

On this instrument, “TIME” refers to the total amount of time required to transition completely from one Mode to another - for example, to change completely from 40 to 400rpm. The “TIME” will be different depending on the starting and ending “rpm” settings - it will take longer to accelerate from 40 to 400rpm than from 60 to 340rpm, as an example. The illustration above shows examples of this.

MICROPHONE SETTINGS

These Parameters allow you to replicate various Microphone Volume settings and Microphone placements for a Leslie Speaker Cabinet.

1 VOLUME - HORN / DRUM / SUB BASS (L)

Setting Range: -INF, -76 ~ 0 [dB]

These allow you to adjust the volume levels of the Horn Rotor, Drum Rotor and Sub Bass

NOTE: The Sub Bass sound is “dry” - not modulated.

2 WIDTH - HORN / DRUM (L)

Setting Range: 0 ~ 40 [cm]

These allow you to adjust the distance between Left and Right Microphones. At “0” there is no separation.

A higher value will increase the stereo separation.

3 CENTER - HORN / DRUM (L)

Setting Range: -50 ~ +50 [cm]

This allows you to adjust the offset between the center of two microphones and the pivot of the rotor.

4 DISTANCE - HORN / DRUM (L)

Setting Range: 30 ~ 200 [cm]

These are for replicating distance settings between a Leslie Speaker and the microphones. A lower value results in a deeper effect.

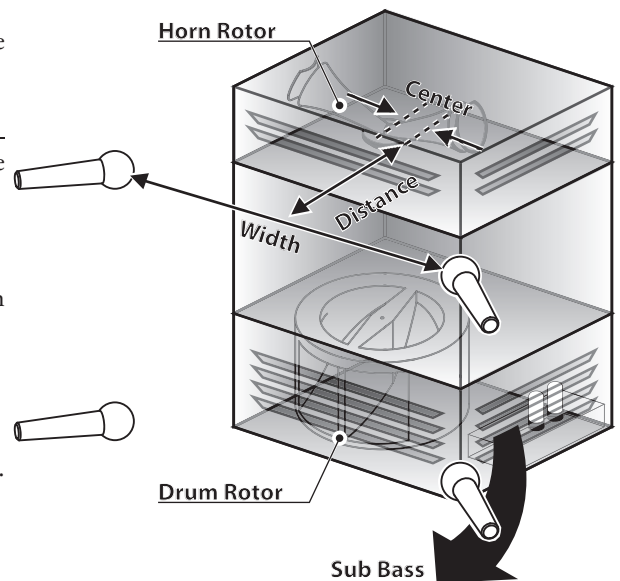

tips ADJUSTING THE CENTER

On a Leslie Speaker Cabinet the Horn Rotor rotates counter-clockwise and the Drum Rotor rotates clockwise. The digital Leslie replicates this feature. Setting a “+” value for the Horn rotor, and a “-” value for the Drum rotor will emphasize different directions from which the Horn and Drum baffles approach the microphones.

NOTE: The Parameters labeled “L” are Leslie Parameters. You must Record these Parameters to a Custom Leslie Cabinet if you want their settings to be remembered the next time the instrument is turned “ON.” See page 104 for instructions on how to do this.

CUSTOM PIPE

This FUNCTION Mode allows you to select or edit the characteristics of the Pipe Voices.

The Parameters described on these pages are grouped in macro-settings called **Custom PIPES**. These Parameters cannot be Recorded as individual Patch Parameters; however, a Custom Pipe can be Recorded as part of a Patch.

To locate this mode:

[MENU/EXIT] - **CUSTOM - PIPE** - [ENTER]

SET



tips CUSTOM PIPES

The XK-4 has 4 different Factory Custom Pipes, indicated by an “F” which are permanently written in memory. You can create and Record up to 4 User Custom Pipes which will be indicated by a “U.” To create and Record a Custom Pipe, use the PIPE FUNCTION Mode to edit the Parameters of one of either the “F” or “U” Custom Pipes. After you have made all of your changes, you can Save them as a “U” Custom Pipe.

1 CUSTOM SET (P)

Setting Range: F1 ~ F4, U1 ~ U4

This allows you to select the Custom Pipe Number to edit.

The letter “F” stands for Factory (non-re-writable) and “U” stands for User (re-writable).

UPPER / LOWER / PEDAL STOP SET

This allows you to assign Pipe Voices to the Drawbars and to adjust the Parameters of each Stop to your preference. Each Parameter is explained in detail starting below.

PIPE	F1	Classic	Classic						
MENU - CUSTOM EDIT - PIPE			M EDIT - PIPE						
UPPER STOP SET			TOP SET						
	STOP	VOL [dB]	FTG	TUNE	TREM	CHIEF	C.OFF	PAN	IMAGE
UPPER 1	S04	-2.5	16'	0	On	Soft	-25	L16	LtoL
UPPER 2	S01	-2.5	8'	0	On	Loud	-28	L24	LtoR
UPPER 3	S06	-1.5	8'	0	On	Loud	0	L20	LtoR
UPPER 4	S10	-5.5	8'	0	On	Soft	-35	L12	LtoR
UPPER 5	S02	-8.0	4'	0	On	Loud	-23	L8	LtoR
UPPER 6	S05	-9.5	4'	0	On	Loud	-23	L10	LtoR

UPPER 1 S04 : [Classic] Bourdon 1 : [Classic] Bourdon 1

Buttons: SET, UPPER DB, LOWER DB, PEDAL DB, UPPER DB, LOWER DB, PEDAL DB, DAL DB

1 STOP (Pi)

This allows you to assign a Pipe Stop to each of the Drawbars.

NOTE: See page 147 for a list of the available Pipe Stops.

2 VOLUME (Pi)

Setting Range: -Inf, -92.0 ~ +4.0 [dB]

This allows you to adjust the Volume of each Pipe Stop.

3 FOOTAGE (Pi)

Setting Range: 32, 16, 5 1/3, 8, 4, 2 2/3, 2, 1 3/5, 1 1/3, 1

This allows you to adjust the Pitch of each Pipe Stop. The pitches are expressed in Footages.

NOTE: See page 44 for more information about Drawbars and their Footage designations.

4 TUNE (Pi)

Setting Range: -50 ~ ±0 ~ +50 [cent]

This allows you to detune the pitch of the selected Pipe Voice Up or Down by cents (50 cents = one quarter-step).

tips TREMULANT

Pipe organs typically have one or more “tremulants” which vary the air pressure to the pipes periodically, producing a vibrato or tremolo effect.

5 TREMULANT (Pi)

Settings: Off, On

This allows you to add Tremulant to the Pipe Voices using the [VIBRATO/CHORUS] controls.

6 CHIFF (Pi)

Settings: Off, Soft, Mid, Loud

This allows you to adjust the amount of Chiff or attack for the selected Pipe Voice.

OffNo Chiff.

SoftA small amount of chiff.

MidA moderate amount of chiff.

LoudThe maximum amount of chiff.

NOTE: Reed stops such as "Hautbois," "Trompette" "Cornocean," etc., do not receive Chiff.

7 CUTOFF (Pi)

Setting Range: -127 ~ 0

This allows you to adjust the Cutoff Frequency (brightness).

8 PAN (Pi)

Setting Range: L64 ~ C ~ R63

This allows you to adjust the basic direction of the Pipe Rank.

9 IMAGE (Pi)

This allows you to replicate different arrangements of pipes in pipe chests.

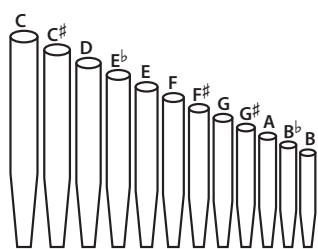
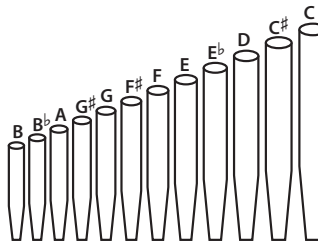
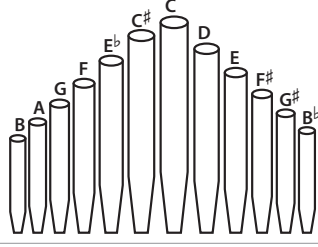
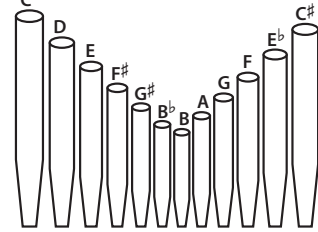
FIX	No image	No imaging - all the notes sound from the center).
L-R		Pipes producing lower pitches are on the left. Playing notes chromatically going up on the keyboard will cause the pipes on the left to sound first
R-L		Pipes producing higher pitches are on the right. Playing notes chromatically going up on the keyboard will cause the pipes on the right to sound first
PYR		When notes are played chromatically going from left to right on the keyboard, the notes start in the center and alternate between left and right
INV		When notes are played chromatically going up on the keyboard, the notes start at one end and alternate between left and right until they meet in the center.

tips WHAT IS "CHIFF?"

On a pipe organ, when a flue stop such as a Diapason, String or Flute is drawn and a key is depressed, a valve opens, and air escapes through the hole in which the pipe sits, allowing the pipe to sound. When the air first enters the pipe, there is a small, short burst of upper harmonics before the tone develops fully. The term "Chiff" was coined by pipe organ makers to describe this sound.

tips WHAT IS "PIPE VOICE IMAGING?"

The pipes of a pipe organ are arranged into sets called **rank**s. Each rank consists of pipes representing a specific sound on the organ - Open Diapason, Trompette, etc. (In keeping with the different philosophies of organ sound, many organ stop names are of European origin; hence the use of French, German, Dutch, etc.)

The pipes of each rank are supported by an assembly called a chest. The pipes can be arranged in many different ways on the chest. The pipe arrangement chosen by the maker depends on several things - aesthetics, musical, etc. - but the four most common ones are shown on the left.

The two pipe placement schemes at the bottom of the chart on the left are sometimes referred to as "C-C#" placement due to chromatic notes being separated.

NOTE: The Parameters labeled (Pi) are Pipe Parameters. You must Record these Parameters to a Custom Pipe if you want their settings to be remembered the next time the instrument is turned "ON." See page 104 for instructions on how to do this.

RECORDING A CUSTOM SETTING

To Record a Custom Setting, do the following:

① PRESS THE RED [RECORD] BUTTON

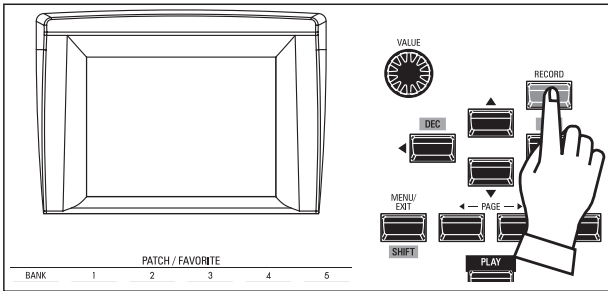

After you have made your changes to a Custom Setting, press the red [RECORD] button. The RECORD Page will display.

② SELECT THE ITEM TO RECORD

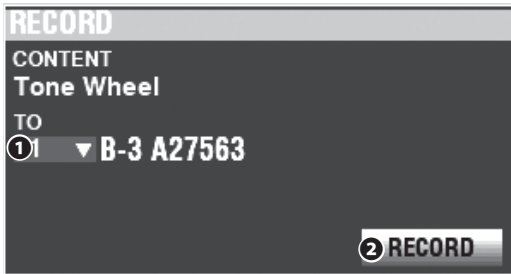

① TO

Use the [VALUE] knob to select the User Number to Record.
NOTE: If edits have been made to a Custom Setting, an "E" will appear to the right of the CONTENT icon.
NOTE: You cannot Record to an "F" setting.

② RECORD

After you have selected the User Number, press the red [RECORD] button. The Naming screen will display.

③ NAME THE CUSTOM SETTING

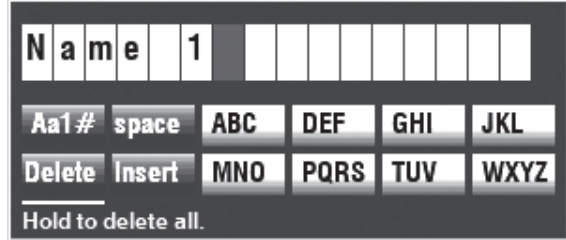

Enter the Name.
[Aa1]..... Changes the character type.
[1] - [10]..... Selects the highlighted character.
[Insert]..... Inserts a space at the cursor.
[Delete]..... Deletes a letter at the cursor.
[VALUE]..... Changes the letter at the cursor.

④ RECORD THE SETTING

After Naming your Custom Setting, press the [ENTER] button. The message shown below will display for approximately 1 second:

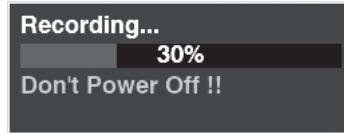

NOTE: Do not turn the power "OFF" while the above message is displaying.
NOTE: If you DO NOT wish to Record, press the [MENU/EXIT] button instead of the [ENTER] button.

When the display shows:

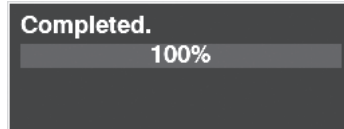

the Recording process is finished and your setting has been Recorded.

NOTE: While connecting between this instrument and a computer via USB cable, the connection may be interrupted for a few moments. This is normal and is not a malfunction..

⑤ RETURN TO THE PLAY MODE

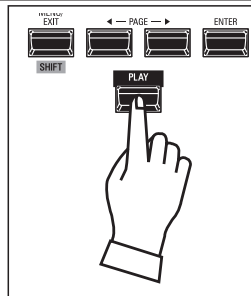

Press the [PLAY] button to return to the PLAY mode.

System Parameters are common parameters for all the Patches in this instrument such as the Parameters for the AUDIO jacks, the MIDI Ports, various Controllers, which portions of the instrument to load when a Patch is selected, etc.

SYSTEM PARAMETERS AND CONTENTS

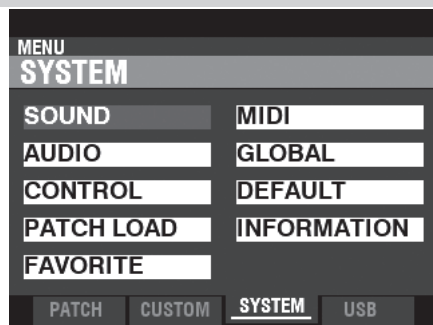

DEFAULT (P. 119)

Initialize each content to factory-default settings

INFORMATION (P. 120)

- ◆ Display Software Versions
- ◆ Update Software

SOUND (P. 106)

- ◆ Master Tune
- ◆ Transpose
- ◆ Master Equalizer

AUDIO (P. 107)

- ◆ [ROTARY OUT] jack
- ◆ [PEDAL OUT] jack
- ◆ Audio channels of the Leslie Speaker system

CONTROL (P. 108)

- ◆ Foot Switch
- ◆ Expression Pedal
- ◆ Damper Pedal
- ◆ [USER] button
- ◆ Tone Wheel Brake
- ◆ Display (action of the knobs and buttons)
- ◆ Keyboard

PATCH LOAD (P. 114)

Contents to load when a Patch is selected.

FAVORITE (P. 116)

- ◆ Input method of the Number buttons
- ◆ Select whether the Number buttons recall Patches or Favorites
- ◆ Edit the Favorites for Patches
- ◆ Edit the Favorites for Display pages

MIDI (P. 132)

- ◆ Purpose of the MIDI Ports
- ◆ Send/Receive a Memory Dump
- ◆ MIDI Channels

GLOBAL (P. 115)

- ◆ Auto Power Off

NOTE: The Parameters in this Mode are System Parameters. You must Record these Parameters to System if you want their settings to be remembered the next time the instrument is turned "ON." See page 118 for instructions on how to do this.

NOTE: The System Parameters are included as part of a Setup. Please see the illustration on page 138 which shows everything that is included in a Setup.

This FUNCTION Mode allows you to adjust the MASTER TUNE, MASTER TRANSPOSE and MASTER EQUALIZER Parameters which affect the entire instrument.

To locate this mode:

[MENU/EXIT] - SYSTEM - SOUND - [ENTER]

MASTER TUNE

App. Menu: PLAY - [≡] - MASTER TUNE (SYSTEM) - [ENTER]

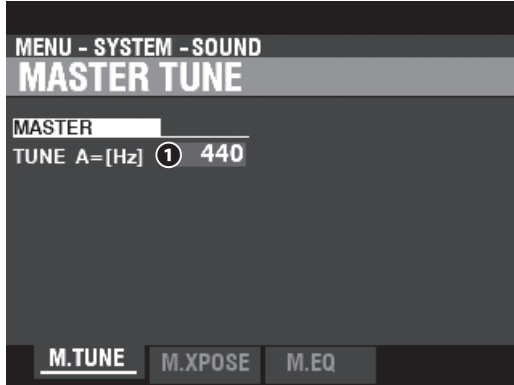

1 MASTER TUNE

Setting Range: A=430 ~ 450 [Hz]

This allows you to adjust the pitch of the entire instrument Up or Down 10 Hz (approx. 40 cents).

MASTER TRANSPOSE

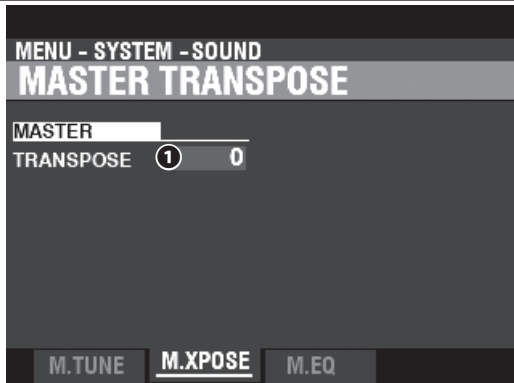

1 MASTER TRANSPOSE

Setting Range: -6 ~ ±0 ~ +6 [semitones]

This allows you to Transpose the entire instrument Up or Down 6 semitones.

NOTE: This Parameter is linked to the [TRANSPOSE] button on the Control Panel.

NOTE: When the power to the XK-4 is turned "OFF," this Transpose setting is not retained. It will be set to "0" when the power is next turned "ON."

MASTER EQUALIZER

Shortcut: [SHIFT] + MASTER EQUALIZER [BASS GAIN], [MID FREQ], [MID GAIN] OR [TREBLE GAIN]

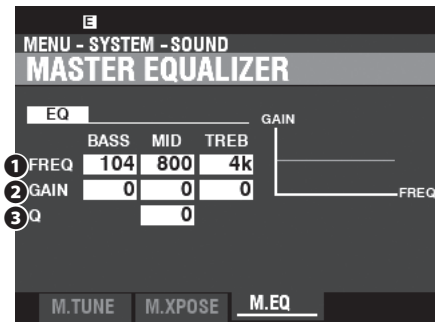
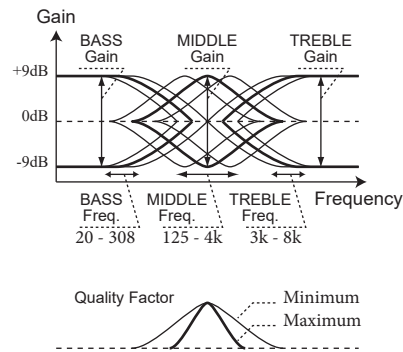

The Master Equalizer allows you to adjust the overall tonal quality of the instrument.

NOTE: These Parameters are linked with the MASTER EQUALIZER knobs on the Control Panel (P. 29).

1 FREQUENCY

Setting Range: 20 ~ 308 [Hz] (BASS)

125 ~ 4k [Hz] (MID)

3k ~ 8k [Hz] (TREB)

These allow you to adjust the center or "turnover" frequency to be attenuated for BASS, MID and TREBLE respectively.

2 GAIN

Setting Range: -9 ~ ±0 ~ +9 [dB]

These allow you to adjust the Boost/Cut of BASS, MID and TREBLE respectively.

NOTE: At "0" the frequency response is "flat."

3 Q

Setting Range: 0 ~ 63

This allows you to adjust the "Q" (Quality Factor) or Resonance of the MID Frequency Band. A higher value results in a greater emphasis of the cutoff frequency, causing a "ringing" effect.

NOTE: Setting both the GAIN and the "Q" at maximum will result in the maximum coloration of the sound. However, it may also result in distortion. If this occurs, reduce the amount of GAIN and/or the amount of "Q."

This FUNCTION Mode allows you to select how to route the audio signals from the instrument.

To locate this mode:

[MENU/EXIT] - **SYSTEM** - **AUDIO** - [ENTER]

AUDIO

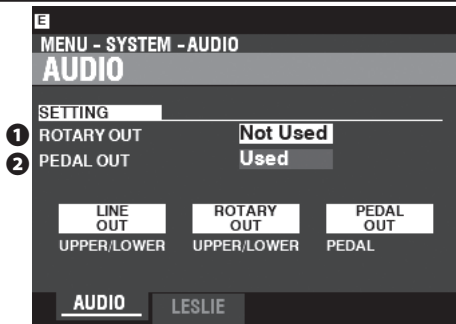

1 ROTARY OUT

Settings: Not Used, Used

This allows you to select whether to route an audio signal from the Tone Wheel or Transistor ORGAN Types to the [ROTARY OUT] jack.

Not Used The audio from the Tone Wheel and Transistor ORGAN Types will be routed to at the [LINE OUT] jacks.

Used The audio from the Tone Wheel and Transistor ORGAN Types will be routed to the [ROTARY OUT] jack instead of the [LINE OUT] jacks.

2 PEDAL OUT

Settings: Not Used, Used

This allows you to select whether to route an audio signal to the [PEDAL OUT] jack.

Not Used The audio from the PEDAL Part of the ORGAN Section will be routed to the [LINE OUT] jacks.

Used The audio from the PEDAL Part of the ORGAN Section will be routed to the [PEDAL OUT] jack instead of the [LINE OUT] jacks.

LESLIE



1 EXTERNAL LESLIE CHANNEL

Settings: 1, 1,w/Pre, 3

This allows you to adjust the correct routing of the audio signals depending on the Leslie Speaker connected to the instrument via the [LESLIE 11-pin] socket.

Ch. Option	Leslie Rotary channel	Line Out and Leslie Stationary channels
1		
3	Tone Wheel and Transistor Organ disregards [BYPASS] regards [BYPASS]	Others

1 If a single channel Leslie Speaker is connected, the audio from the Tone Wheel / Transistor Organs is sent to the Rotary Channel regardless of the status of the [BYPASS] button.

1, w/Pre It works as same as "1", but it has special tonal characteristic which for the Leslie Speaker models with built-in Pre-Amplifier.

3 If a multi-channel Leslie Speaker is connected, the audio from the Tone Wheel / Transistor Organs is sent to the Rotary Channel only if the [BYPASS] button is "ON." If the [BYPASS] button is "OFF," the audio from the Tone Wheel / Transistor Organs is sent to the Stationary Channel(s).

Channels	Models
1	122XB, 981 or 3300/W
1, w/Pre	122H or 142H
3	2101/mk2

NOTE: The Parameters in these Modes are System Parameters. You must Record these Parameters to System if you want their settings to be remembered the next time the instrument is turned "ON." See page 118 for instructions on how to do this.

This FUNCTION Mode allows you to select the Parameters for the various Controls, including Foot Switches, Expression Pedals, controls on the Control Panel and the display.

To locate this mode:

[MENU/EXIT] - **SYSTEM - CONTROL** - [ENTER]

or, Press the [CONTROL] button.

FOOT SWITCH

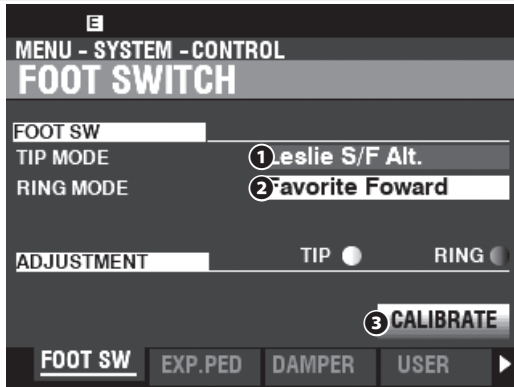

This Page allows you to select the Function of the Foot Switches connected to the [FOOT SWITCH] jacks.

1 MODE - TIP

This allows you to select the function of the “Tip Mode” of a connected Foot Switch.

Off.....No function.

Leslie S/F Alt, Mom, Tri..... Allows you to switch the Leslie Rotors among “Slow/Fast/Stop.”

Alt..... Alternates between “Fast/Slow” or “Fast/Stop” depending on the position of the [STOP] button.

Tri..... Alternates between “Fast/Slow”. Switches to Stop when the foot switch is pressed and held down for approximately 1 second.

Mom..... Switches to Fast while the foot switch is held down. When released, it switches to either Slow or Stop depending on the position of the [STOP] button.

Tone Wheel Brake..... Allows you to bend the pitch, with the amount being determined by a Parameter setting (P. 111).

Patch/Fav. Forward, Backward

..... Allows you to move Forward or Backward through the Patches or Favorites (P. 116).

Spring Shock..... Allows you to produce the effect of a Spring Reverb unit being jostled.

MFx2 Delay Time..... Allows you to adjust the Delay Time of the Effects, at the interval of pressing the Foot Switch. The delayed sound disappears by the Foot Switch is held down (P. 83).

Upper&Lower Sustain..... Allows you to add Sustain to the UPPER and LOWER tones (except Pipe) (P. 70).

Pedal To Lower..... Allows a PEDAL note to sound when PEDAL TO LOWER is “ON” and the Foot Switch is pressed and held (P. 49).

Bass 1C - Bass 3C..... Allows you to trigger a specified note of the PEDAL Part.

NOTE: All of the above functions can be set for either Tip or Ring Mode. However, Ring Mode will have no effect if only one Foot Switch is connected to the FOOT SW jack.

2 MODE - RING

This allows you to select the function of the “Ring Mode” of a connected Foot Switch.

3 CALIBRATE

This allows you to configure a Foot Switch to work properly with the XK-4. To set this Parameter, move the cursor to this icon and press the [ENTER] button without pressing the Foot Switch.

Some Foot Switches, such as Hammond, are “normally open” (make contact when pressed) while others are “normally closed” (break contact when pressed). This Parameter allows you to calibrate each type of Foot Switch for this instrument.

tips WHAT IS “TRS?”

TRS is an acronym for “Tip-Ring-Sleeve,” and refers to the fact that a connecting plug can have more than one connector. Using a Stereo Adapter, more than one Foot Switch can be connected to the XK-4, thereby allowing you to control more than one function using the same Foot Switch jack.

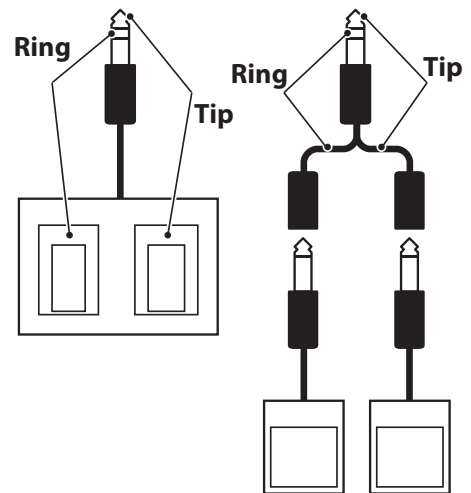

tips PATCH/FAVORITE FORWARD/BACKWARD

By selecting “Patch/Fav. Forward/Backward,” Favorites can be selected sequentially by using the Foot Switch to advance either forward or backward. Also, if either “1” or “10” are selected, the sequence will “roll over” to the next numbered Bank (see the illustration below).

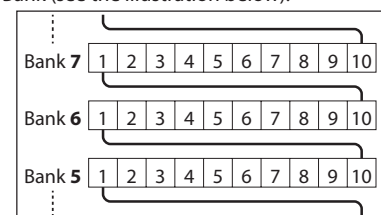

tips SPRING SHOCK

“Spring Shock” occurs when the springs in a spring reverb unit move around and strike the reverb tank, resulting in a loud “bang.” This has usually been regarded as a negative effect; however, some modern and progressive music uses this as a musical effect. This Parameter allows you to introduce the effect of a spring reverb being jostled.

tips BASS 1C - BASS 3C

Many jazz and blues organists provide a bass line with the left hand on the LOWER Manual and strike one PEDAL note at the onset of each bass note to give the effect of a plucked string bass (called a “thump”). The BASS 1C - BASS 3C Parameter allows you to replicate this effect on the XK-4.

EXPRESSION PEDAL

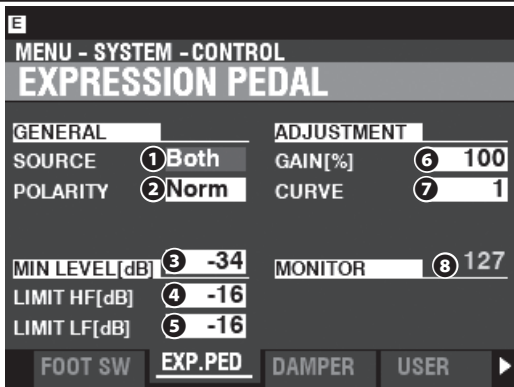

This Page allows you to control how a connected Expression Pedal will function.

1 SOURCE

This allows you to select the source of Expression control.

Exp. Pedal..... Instrument Expression is controlled by a connected Expression Pedal.

MIDI..... MIDI Expression Data (CC#11) will be received at the UPPER Keyboard Channel.

Both..... Instrument Expression is controlled by both Expression Pedal and MIDI Expression data.

2 POLARITY

This allows you to select the polarity type of a connected Expression Pedal (see the illustration on the top right of this page).

HAMMOND... EXP-50J, EXP-20, V-20H, V-20R; **Norm**

KORG..... XVP-10, XVP-20; **Rev**

ROLAND EV-5; **Norm**

YAMAHA..... FC7; **Rev**

3 MINIMUM LEVEL

Setting Range: Off, -40 ~ 0 [dB]

This allows you to select the amount of volume when the Expression Pedal is “closed” or set at its minimum position. At “0” no sound will be heard.

4 LIMIT HF

Setting Range: Off, -40 ~ 0 [dB]

This allows you to adjust the amount of High Frequencies (above 2kHz) that will be heard when the Expression Pedal is set at minimum.

5 LIMIT LF

Setting Range: Off, -40 ~ 0 [dB]

This allows you to adjust the amount of Low Frequencies (below 500Hz) that will be heard when the Expression Pedal is set at minimum.

6 GAIN

Setting Range: 70 ~ 130 [%]

This allows you to adjust the range of a connected Expression Pedal. To set this parameter, depress the connected Expression Pedal at maximum, and set this parameter to the minimum value that the Expression Monitor 8 indicates “127”.

7 CURVE

Setting Range: 1 ~ 3

This allows you to select the “curve,” or change of expression value corresponding to the angle of the Expression Pedal when depressed (see the illustration on the right).

8 MONITOR

Setting Range: 0 ~ 127

This allows you to display the current Expression Value, with “0” being minimum Expression (no audible sound) and “127” being maximum Expression. The Expression Monitor can be useful as a troubleshooting aid if you either don't hear any sound or can't change the volume using a connected Expression Pedal.

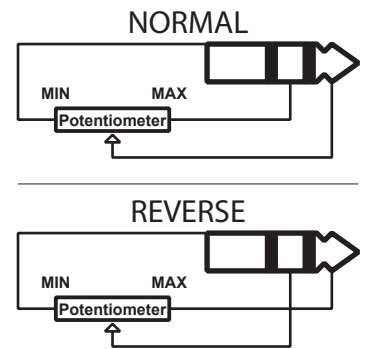

Expression Pedal Polarity Types

tips EXPRESSION LIMIT

On many home audio components, there is a control called “Loudness.” This is intended to correct an anomaly of the human ear whereby high and low frequencies appear to be lacking at low volume levels.

The XK-4 incorporates a “Loudness” algorithm similar to the one found on home audio. At lower volume levels, both high and low frequencies are boosted so that a flatter frequency response will be perceived by the ear.

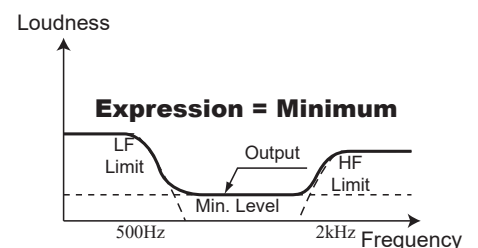
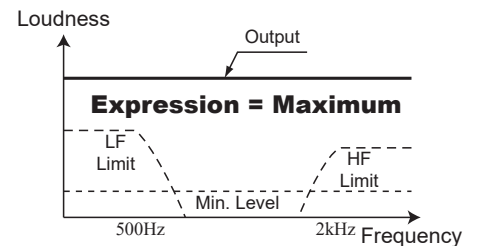

Expression Limit

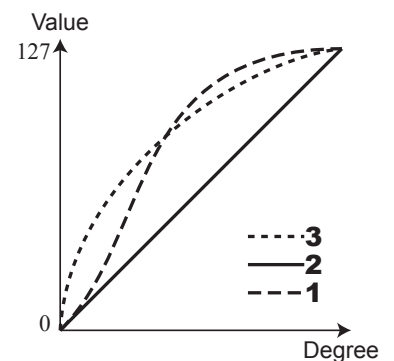

Expression Curve

DAMPER

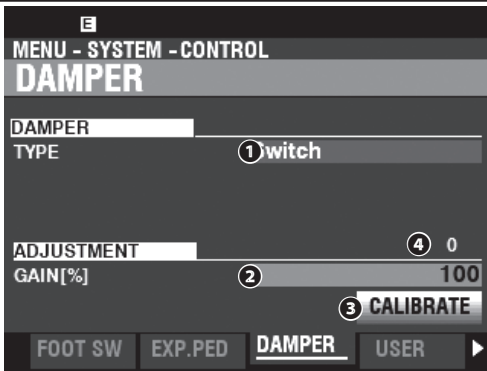

This Page allows you to adjust Parameters for the Damper Pedal.

1 TYPE

This allows you to adjust the type of the Damper Pedal to connect (see the illustration on the right).

HAMMOND ... FS-9H, VFP1; **Switch**

KORG DS-1H; **Half-K**

ROLAND DP-10; **Switch** (Switch), **Half-R** (Continuous)

YAMAHA FC3A; **Half-Y**

YAMAHA FC4A, FC5; **Switch**

2 GAIN

Setting Range: 70 ~ 130 [%]

This allows you to adjust the range of a connected Damper Pedal. You can select from “70%” through “130%,” however, the amount of audible change may differ depending on the specific Damper Pedal used. Use this Parameter to obtain the desired response from your particular pedal.

3 CALIBRATE

This allows you to configure a Damper Pedal to work properly with the XK-4. To set this Parameter, move the cursor to this icon and press the [ENTER] button without pressing the Damper Pedal.

This icon is available with the **1** TYPE set at “Switch.”

4 MONITOR

This allows you to see the current Damper value.

tips DAMPER TYPES

There are various types of Damper or Sustain Pedals. The XK-4 supports the types shown below.

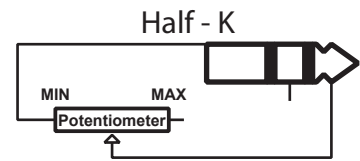
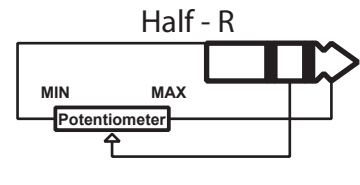
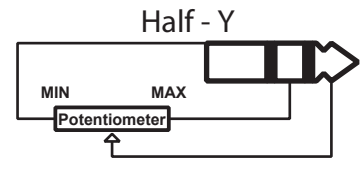
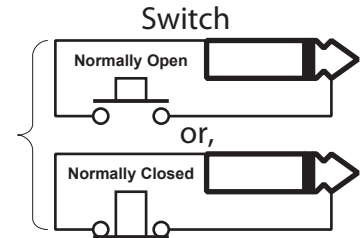

USER

Shortcut: [SHIFT] + [USER]

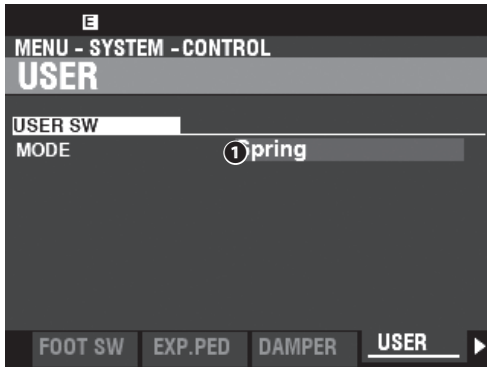

1 MODE

This allows you to assign a function to the [USER] button.

- Off** No function.
- Organ Upper Sustain** Allows you to turn UPPER Sustain "ON" or "OFF" (P. 70).
- Organ Lower Sustain** Allows you to turn LOWER Sustain "ON" or "OFF" (P. 70).
- Tone Wheel Brake** Allows you to bend the pitch, with the amount being determined by a Parameter setting (P. 111).
- Spring Shock** Allows you to produce the effect of a Spring Reverb unit being jostled.
- MFX2 Delay Time** Allows you to select the amount of Delay of the MULTI EFFECT 2 **Delay** Parameter. When this mode is selected, pressing the [USER] button twice will set the Delay Time at the interval between the first and second button presses. You can cancel the Delay by Pressing and Holding the [USER] button (see page 83).
- MFX1/2** Allows you to turn the selected MULTI EFFECT 1 or MULTI EFFECT 2 "ON" or "OFF" (P. 75).
- External Zone 1/2/3** Allows you to turn each External Zone "ON" or "OFF" (P. 89).

TONE WHEEL BRAKE

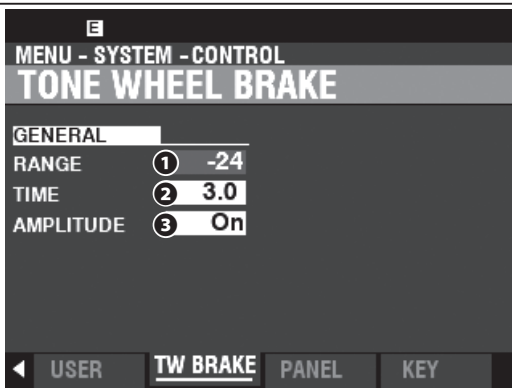

This allows you to adjust the Tone Wheel Brake effect.

1 RANGE

Setting Range: -24 ~ +12 [semitones]

This allows you to adjust the range of the pitch change.

2 TIME

Setting Range: 0.1 ~ 5.0 [seconds]

This allows you to adjust the rate at which the pitch changes.

3 AMPLITUDE

Settings: Off, On

This allows you to select whether the Volume will change along with the Pitch.

tips TONE WHEEL BRAKE

On a vintage B-3/C-3, the synchronous motor driving the tone generator turns at a constant speed; therefore "pitch bending" is not possible. However, some jazz players discovered that by turning the RUN switch "OFF" then quickly back "ON" again, a pseudo "pitch-bend" effect could be created. You can replicate this effect using this function.

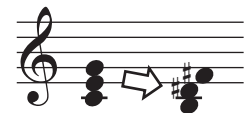

NOTE: The Parameters in these Modes are System Parameters. You must Record these Parameters to System if you want their settings to be remembered the next time the instrument is turned "ON." See page 118 for instructions on how to do this.

PANEL

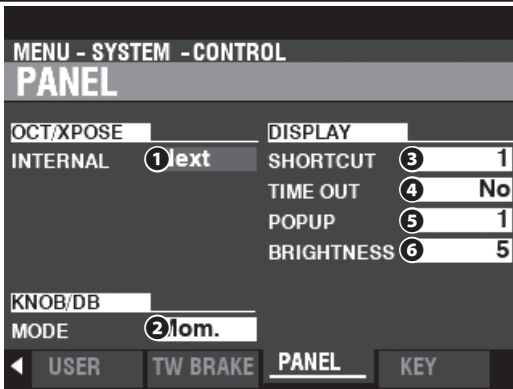

This Page allows you to adjust the performance of the various controls on the Control Panel.

OCT/XPOSE(TRANSPOSE)

1 INTERNAL

Setting Range: Every, Next

These allow you to adjust how the OCTAVE [DOWN] [UP] buttons control Octave selection or Transposition.

Every The Octave or Transposition will change while keys are pressed and held.

Next If a key or keys are pressed and held and the Octave or Transposition is changed, the key(s) must be released and pressed again before the Octave or Transposition takes effect.

tips USING “EVERY” AND “NEXT”

“Every” is most useful when accompanying a singer or instrumental soloist and attempting to find a comfortable key, while “Next” is effective when changing keys in the middle of a song.

KNOB/DB(DRAWBARS)

6 MODE

Settings: Mom, Across

This allows you to adjust how a value is affected when a knob or Drawbar is moved.

Mom When a knob or Drawbar is moved, the value will change immediately.

Across When a knob or Drawbar is moved the value will not change until the current value is arrived at by the movement of the knob or Drawbar, at which point the value will change.

tips USING “MOM” AND “ACROSS”

When “Mom” (Momentary) is selected and a knob or slider is moved, the value changes instantly. However, there may be occasions when you want a value to change gradually instead of suddenly. Select “Across” to change values gradually. This is especially helpful when selecting Patches since you can use “Across” to “morph” one Patch into another.

DISPLAY

1 SHORTCUT

Setting Range: 0 ~ 2 [sec], No

This allows you to select how long a button must be held before the FUNCTION Mode Page controlled by that button appears.

NOTE: If you select “No,” the Shortcut feature is disabled.

2 TIME OUT

Setting Range: 4 ~ 16 [sec], No

This allows you to select how long the display will continue to show a FUNCTION Mode Page via the “Shortcut” before reverting to PLAY Mode.

NOTE: If you select “No,” the current FUNCTION Mode Page will continue to display until another page is selected.

3 POP UP

Setting Range: No, 0.5 ~ 2.0 [sec]

This allows you to select the interval at which a “Pop Up” is displayed when you move a knob such as [REVERB].

NOTE: If you select “No,” the current Pop Up will continue to display until another page is selected.

4 BRIGHTNESS

Setting Range: 1 ~ 10

This allows you to adjust the brightness of the backlight of the display.

A higher value will result in a brighter display.

KEYBOARD

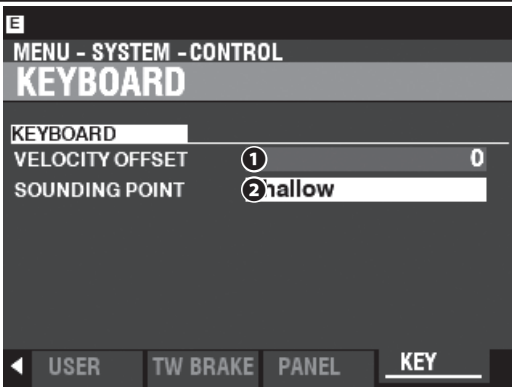

This Page allows you to adjust the performance of the keyboard of this instrument.

1 VELOCITY OFFSET

Setting Range: -32 ~ ±0 ~ +32

This allows you to adjust the relative velocity of notes played on the keyboard.

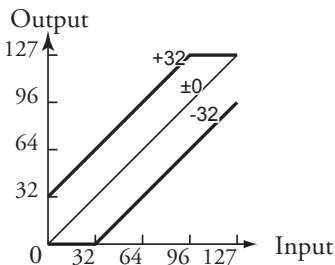

NOTE: The Upper and Lower Note Velocity limits are from “1” (lowest level) to “127” (highest level) to conform to the MIDI specification..

2 SOUNDING POINT

Setting Range: Shallow, Deep

This allows you to select the sounding point of the internal sound engine.

Shallow..... The note or notes will sound at a shallower key depth than a non-organ keyboard instrument such as a synthesizer.

Deep..... The note or notes will sound at the same key depth as the a non-organ keyboard instrument.

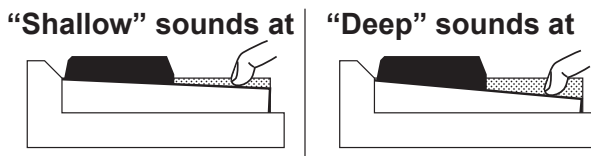

NOTE: If “Shallow” is selected and a key is depressed, the ORGAN Section will sound when the key travel reaches the “Shallow” sounding point, but MIDI Note data will not be transmitted unless or until the key reaches the “Deep” sounding point. If the key reaches the “Shallow” sounding point but does not travel all the way down to the “Deep” sounding point, MIDI Note data will not be transmitted.

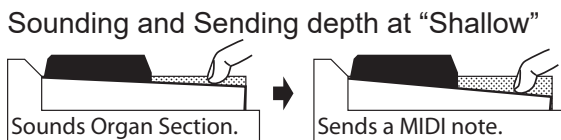

NOTE: The Parameters described on these pages are System Parameters. You must Record these Parameters to System if you want their settings to be remembered the next time the instrument is turned “ON.” See page 118 for instructions on how to do this.

PATCH LOAD

This FUNCTION Mode allows you to select which Parameters of the instrument will be Recalled as part of a Patch.

To locate this mode:

[MENU/EXIT] - **SYSTEM** - **PATCH LOAD** - [ENTER]

PATCH LOAD

MENU - SYSTEM - PATCH LOAD			
PATCH LOAD			
PATCH			
REG. UPPER	On	EFFECT	On
REG. L/P	On	REVERB	On
DB PARAM	On	CONTROL	On
ANIMATION	On	ASSIGN	On
PERCUSSION	On	INT.ZONE	On
		EXT.ZONE	On
PAT.LOAD			

This Page allows you to select which Parameters to include as part of a Patch.

REG. UPPER.....UPPER Drawbar Registration.

REG. L/P.....LOWER and PEDAL Drawbar Registrations.

DB PARAM.....General ORGAN Section Parameters such as Drawbar (except Drawbar Registration), Contact & Sustain.

ANIMATION.....Vibrato and Chorus, Leslie.

PERCUSSION.....Percussion Parameters.

EFFECT.....Matching Transformer, Overdrive, Multi Effects 1&2, Equalizer.

REVERB.....Reverb effect.

CONTROL.....Damper Pedal, Pitch Bend, Modulation Wheel.

ASSIGN.....ASSIGN [1] [2] knobs and buttons.

INT. ZONE.....Internal Zones.

EXT. ZONE.....External Zones.

All the Parameters described here have “On” and “Off” settings.

On.....The Parameter setting will be remembered as part of a Patch

Off.....The Parameter setting will not be remembered as part of a Patch.

tips PATCH LOAD EXAMPLE

When a Patch is selected,

Example 1: On a vintage B-3/C-3, changing an UPPER Preset will change only the Drawbar registration for the UPPER Manual. To replicate this on the XK-4, turn the REG. UPPER Parameters “ON” and turn all the other Parameters “OFF.”

Example 2: To change the External Zones only, turn the EXT. ZONE Parameters “ON” and turn all the other Parameters “OFF.”

NOTE: The Parameters described on these pages are System Parameters. You must Record these Parameters to System if you want their settings to be remembered the next time the instrument is turned “ON.” See page 118 for instructions on how to do this.

This FUNCTION Mode allows you to control the AUTO POWER OFF feature.

To locate this mode:

[MENU/EXIT] - **SYSTEM** - **GLOBAL** - [ENTER]

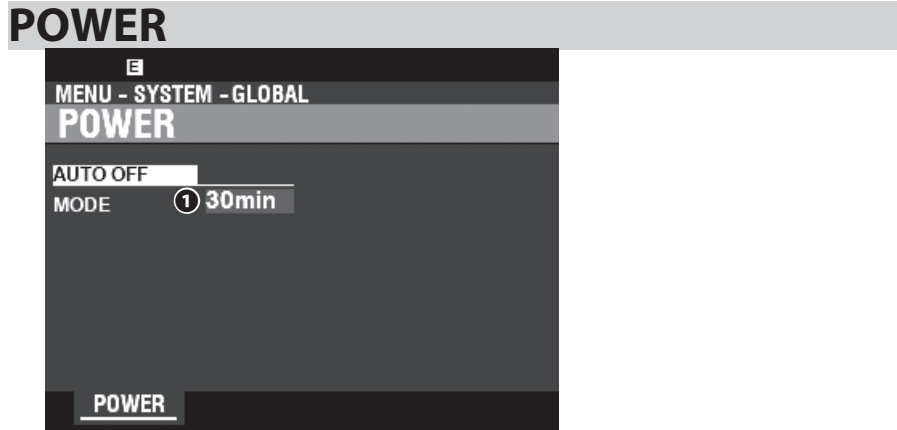

AUTO OFF

① MODE

This allows you to select whether the power to the instrument is automatically turned “OFF” after a certain time period.

30min The AC power to the instrument will turn “OFF” after 30 minutes have elapsed with no keys or buttons being pressed.

Disable The instrument will turn “ON” or “OFF” with the AC Power Switch, but not turn “OFF” automatically.

NOTE: AUTO POWER OFF is a System Parameter. You must Record this Parameter to System if you want it to be remembered the next time the instrument is turned “ON.” See page 118 for instructions on how to do this.

This FUNCTION Mode allows you to control how Banks & Patches or Favorites are recalled using the numbered buttons.

To locate this mode:

[MENU/EXIT] - SYSTEM - FAVORITES - [ENTER]

PATCH/FAVORITE

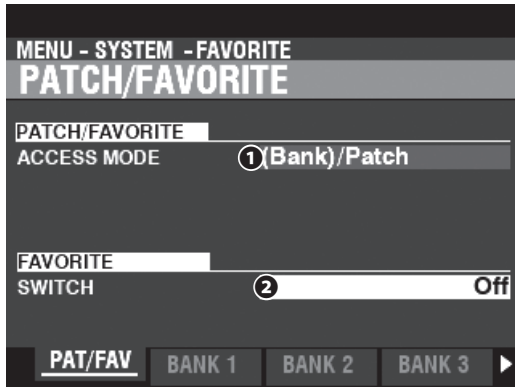

1 ACCESS MODE

Setting Range: (Bank)/Patch, 2-button input

This allows you to select the method by which the Number buttons recall Patches or Favorites.

(Bank) / Patch:

If the Patch/Favorite you want to recall is in a different Bank of the current one, select the Bank number then the Patch Number. If the Patch/Favorite is in the current Bank, select only the Number.

ex1) To recall the Patch U5-3 or Favorite 5-3,

[BANK]+[5] [3]
Input Bank Input Number

if current bank is U5, press

[3]
Input Number

ex2) To record the Patch U5-3 or register Favorite 5-3

[BANK]+[5] [RECORD]+[3]
Input Bank Input Number

if current bank is U5, press

[RECORD]+[3]
Input Number

2-button input:

Select the Bank and Number using 2 buttons.

ex1) To recall the Patch U5-3 or Favorite 5-3,

[5][3]
Input Bank and Number

ex2) To record the Patch U5-3 or register Favorite 5-3,

[RECORD]+[5][3]
Input Bank and Number

2 FAVORITE SWITCH

Setting Range: Off, On

This allows you to select whether the Number buttons will select Patches or Favorites.

Off: The Number buttons selects a User Patch number.

On: The Number buttons selects a Favorite number.

NOTE: The [VALUE] knob always selects all the Patch numbers regardless of the setting of this Parameter.

BANK 1 - 10

Shortcut: Press and Hold any Number button [1] to [10] (when the FAVORITE SWITCH on the left column is at "ON").

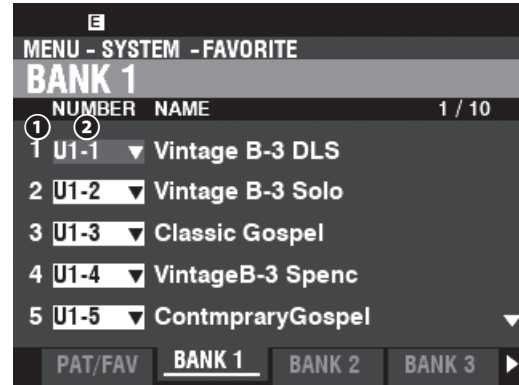

This allows you to associate and confirm the assignment of Patch to Number buttons when the FAVORITE is at "On."

1 Favorite Number

This shows the Number button containing the Favorite.

2 Patch Number

Allows you to assign the Patch associated with this Favorite number.

The Patch is recalled automatically by highlighting the Bank and Patch number and using the [VALUE] knob to select the desired Bank and Patch number.

To recall a Favorite from PLAY mode, see "USING NUMBER BUTTONS." (P. 26)

tips WHAT IS A "FAVORITE"?

The "Favorite" function allows you to use the Number buttons to recall Patches from different Banks.

By preparing your Favorites before your performance, you can play the songs on your Set List one after the other by pressing the Number buttons in sequence, or using a connected Foot Switch (see page 108).

tips USING THE BANK 1-10 PAGES

On the BANK 1-10 Pages, the Patch will be recalled by locating the cursor to a Favorite.

You can recall the "previous" or "next" Favorite by using the DIRECTION [▲]/[▼] buttons.

DISPLAY

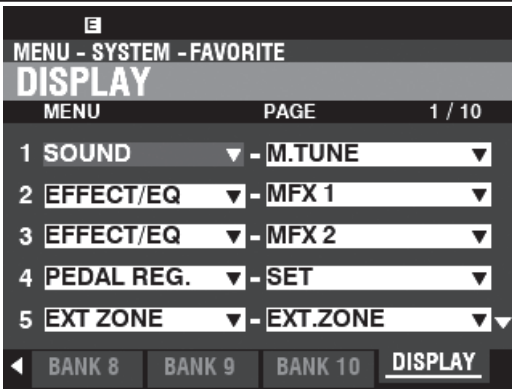

This page allows you to associate and confirm the assignment of FUNCTION Mode pages to numbered buttons.

NOTE: You can also use the buttons on the Information Center to assign a Menu page to a NUMBER button (P. 63).

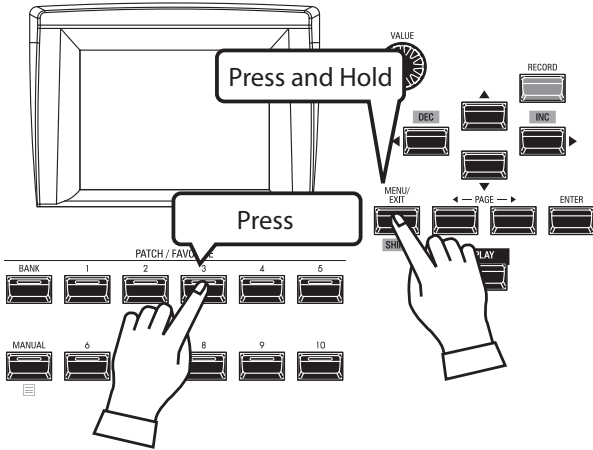

To locate an registered display page, Press and Hold the [SHIFT] button and press a Number button.

NOTE: The Parameters in this Mode are System Parameters. You must Record these Parameters to System if you want their settings to be remembered the next time the instrument is turned "ON." See page 118 for instructions on how to do this.

RECORDING SYSTEM PARAMETERS

To Record the System Parameters of the XK-4, do the following:

① PRESS THE RED [RECORD] BUTTON

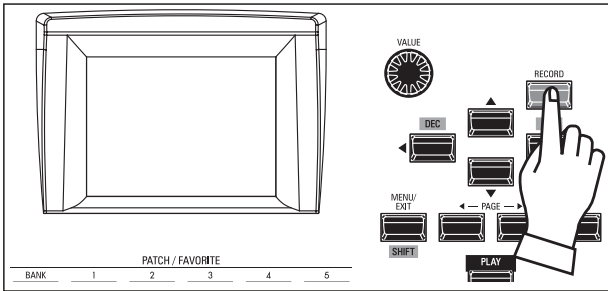

After you have made your changes to SYSTEM Parameters, press the red [RECORD] button. The RECORD Page will display.

④ RETURN TO THE PLAY MODE

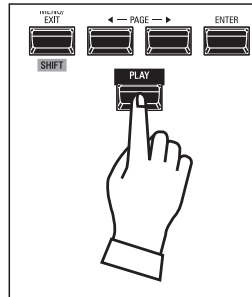

Press the [PLAY] button to return to the PLAY mode.

② SELECT THE ITEM TO RECORD

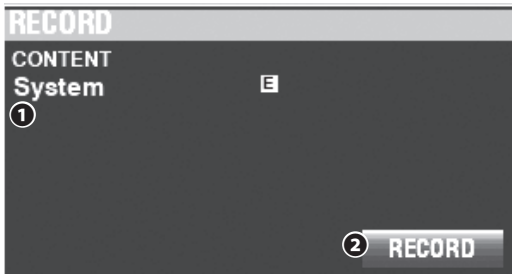

① CONTENT

The content to Record will be highlighted.
System System Parameters.

NOTE: If edits have been made to a System Setting, an "E" will appear in the display as shown above.

③ RECORD THE SETTING

Press the [ENTER] button. The message shown below will display for approximately 1 second:

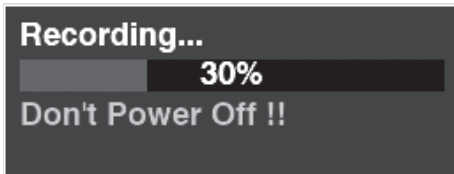

NOTE: Do not turn the power "OFF" while the above message is displaying.

NOTE: If you DO NOT wish to Record, press the [MENU/EXIT] or [PLAY] button instead of the [ENTER] button.

When the display shows:

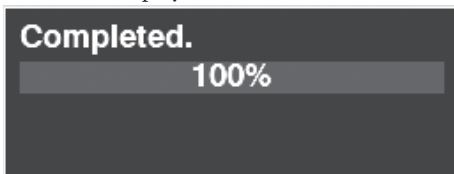

the procedure is finished.

This FUNCTION Mode allows you to reset the XK-4 to factory-default settings.

TO LOCATE THIS MODE:

[MENU/EXIT] - **SYSTEM** - **DEFAULT** - [ENTER]

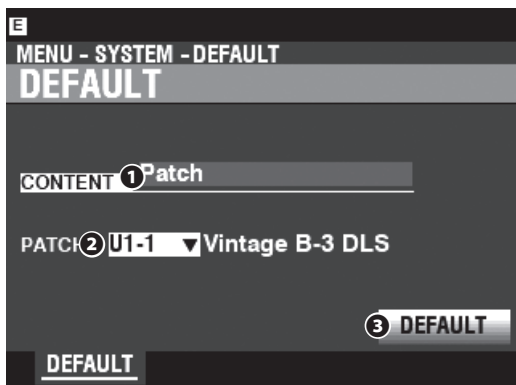

To reset the instrument to the factory-default settings, do the following:

1 CONTENT

From the above screen, use the [VALUE] knob to select the content to be initialized.

- Patch
- Custom Tone Wheel
- Custom Pedal Registration
- Custom Leslie Cabinet
- Custom Pipe
- System
- All

2 NUMBER

Use the DIRECTION [▼] button to move the cursor down and select the item to Delete. You can select each individual User Number as well as "ALL" (all the User Numbers).

3 DEFAULT

Use the DIRECTION [▼] button to move the cursor to the [DEFAULT] icon and press the [ENTER] button. The message shown below will display for approximately 15 seconds:

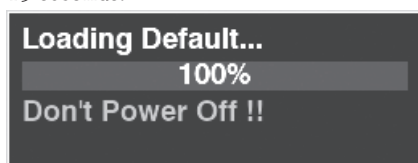

NOTE: Do not turn the power "OFF" while the above message is displaying.

NOTE: If you DO NOT wish to Default the instrument, press the [MENU/EXIT] or [PLAY] button instead of the [ENTER] button

When the display shows:

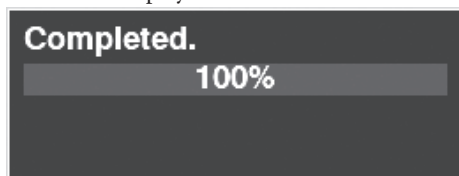

the procedure is finished.

tips "USER" CONTENTS AS SHIPPED FROM THE FACTORY

As explained previously, the XK-4 has both "U" (User) and "F" (Factory) Patches and Custom settings. The "U" Patches and Custom settings come from the factory with the same settings as the "F" Patches and Custom settings - Patches "F1" and "U1" are identical, for example. The difference is that "F" settings cannot be overwritten while "U" settings can be modified and Recorded to your preference.

This FUNCTION Mode allows you to see the status of connected devices as well as the status of the currently installed software. It also allows you to update the system software.

TO LOCATE THIS MODE:

[MENU/EXIT] - SYSTEM - INFORMATION - [ENTER]

STATUS DISPLAY

IS ACTIVE

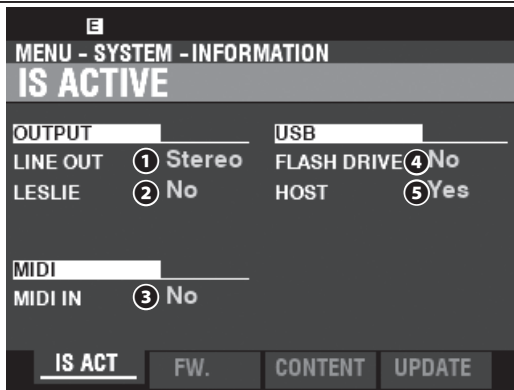

This allows you to see which peripheral devices are connected.

1 LINE OUT

Settings: Mono, Stereo

This allows you to adjust how the sounds from the XK-4 are routed to the [LINE OUT] jacks.

NOTE: The full effect of the sounds produced by the XK-4 is best heard in "Stereo" (both LINE OUT jacks connected to two sound sources physically separated). If only the L/MONO jack is connected, the "Pan" function will not be heard.

2 LESLIE

Settings: No, Yes

This allows you to see the connecting status of the XK-4 to a Leslie Speaker Cabinet via the 11-pin [LESLIE] socket.

3 MIDI IN

Settings: No, Yes

This allows you to see the connecting status of the XK-4 to a MIDI device via the [MIDI IN] Port.

NOTE: This shows the receiving condition of the "Active Sense" message. It may display "No" even if properly hooked-up if the connected device does not transmit "Active Sense" messages (such as the XPK-100 Pedalboard).

4 FLASH DRIVE

Settings: No, Yes

This allows you to see the connecting status of a USB Flash Drive. Use this Parameter to determine if a USB Flash Drive is compatible with the XK-4.

5 HOST

Settings: No, Yes

This allows you to see the connecting status between the XK-4 and a computer via a USB cable.

VERSION - FIRMWARE

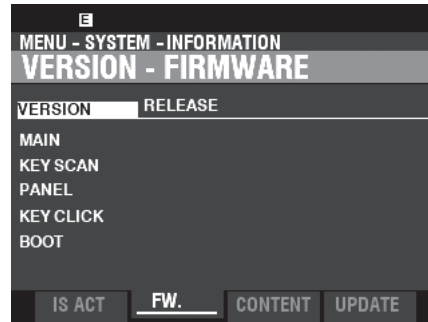

This allows you to see the versions of the main system software.

RELEASE Release Number.

MAIN Main Processor.

SUB Sub Processor.

KEY SCAN Key scan Processor.

PANEL Control Processor.

BOOT Bootstrap Loader.

VERSION - CONTENTS

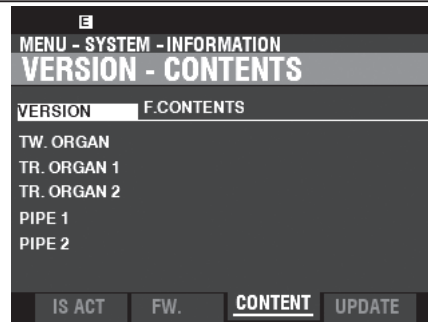

This allows you to see the versions of the Voice Cells.

F. CONTENT Factory Patch or Custom contents.

TW.ORGAN Tone Wheel Organ.

TR.ORGAN 1 Transistor Organ 1.

TR.ORGAN 2 Transistor Organ 2.

PIPE 1 Pipe Organ 1.

PIPE 2 Pipe Organ 2.

UPDATE

See "Updating the Software" on page 121 for more information.

The system software of the XK-4 may be updated periodically to incorporate new features, etc. This page provides instructions on how to update the instrument software.

PREPARING OPERATING TIME

The update process may take several minutes depending on the extent of the update. Therefore, if you are updating the System Software, be sure you set aside enough time in an environment with a continuous AC power supply.

PREPARING UPDATE FILES

① DOWNLOAD THE UPDATE

Go to the Hammond website for your region and download the software update to the desktop of your computer. It will be a compressed file containing several files called a “.zip” file.

② UNZIP THE FILE

Find the “.zip” file on your computer desktop and un-ZIP it. A folder will be created on your desktop having the same name as the “.zip” file which will contain the software update files, called “.bin” files.

NOTE: Some web browsers will automatically un-ZIP a “.zip” file after it has been downloaded.

PREPARING MEDIA

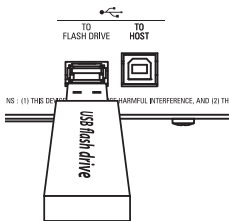

Turn on this instrument, and insert the USB Flash Drive into the [TO FLASH DRIVE] port.

The message, “Confirming USB...” will display for approximately 1 second. Please wait for this message to disappear. The folders and sub-folders necessary for use with this instrument (P. 136) have been created.

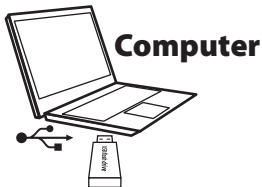

After doing the above, remove the USB Flash Drive from the keyboard and insert it into the computer.

UPDATING PROCEDURE

① COPY THE “BIN” UPDATE FILE(S)

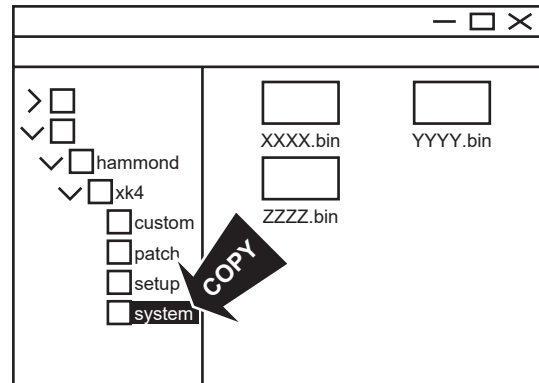

Copy the “.bin” update files into the “system” sub-folder of the USB Flash drive or the Internal Memory.

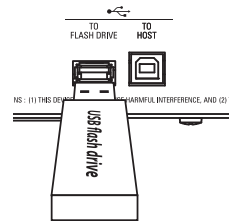

Remove the Flash Drive from your computer and insert it into the [TO FLASH DRIVE] port of this instrument. The message, “Confirming USB...” will display for approximately 1 second. Wait for this message to disappear.

② LOCATE THE “UPDATE”

Locate the UPDATE FUNCTION Mode Page:

[MENU/EXIT] - **SYSTEM** - **INFORMATION** - [ENTER] - **UPDATE**

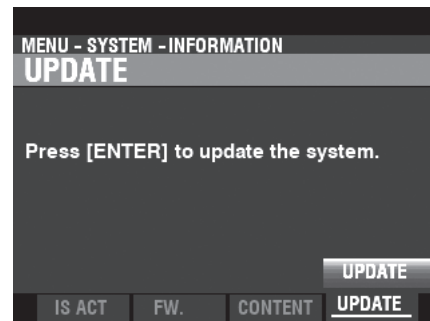

The following messages will show if there are no update files on the USB Flash Drive:

- No Update File**No “.bin” files in the \system\ Folder.
- No New Update File**.....The “.bin” files are either identical to or older than the ones already installed.

(Continued on the next page.)

③ START THE UPDATE

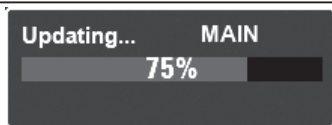

Press the [ENTER] button. You will see a status bar similar to the one shown above during the Update procedure. Each file being installed will display a separate status bar.

④ FINISH

When the update is finished, the message shown below:

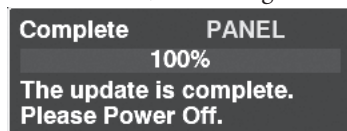

will display. Turn the power to this instrument "OFF."

When the power to this instrument is next turned "ON," the updated software will take effect.



MIDI

WHAT IS “MIDI”?

“MIDI” (**M**usical **I**nstrument **D**igital **I**nterface) is the musical instrument industry standard for exchanging performance information between electronic musical instruments as well as sequencers, effects, lighting and sound reinforcement gear, etc.

The MIDI standard allows instruments made by different manufacturers to communicate with each other.

Many types of data can be transmitted and received, including performance information, Parameter settings, and global commands.

WHAT IS “USB”?

USB (**U**niversal **S**erial **B**us) is an industry standard for connection, communication and interfacing between computers, peripherals and other electronic devices. There are many different types of USB connectors; however the XK-4 implements Type “A” and Type “B” connectors, which are the most common types for electronic musical instruments.

MIDI/USB JACKS ON THE XK-4

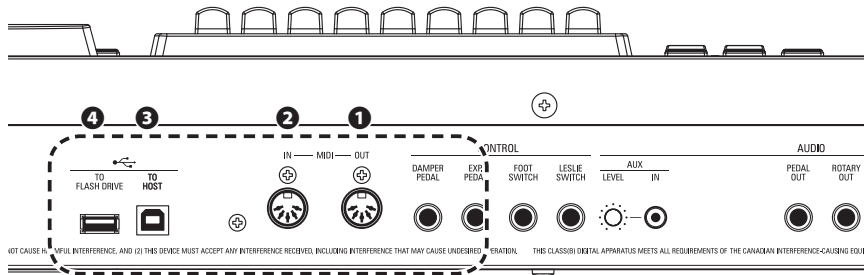

1 MIDI OUT Port

This Port transmits performance information to an external MIDI device such as a sound module, sequencer or Digital Audio Workstation (DAW).

2 MIDI IN Port

This Port receives MIDI information from an external MIDI device such as a sequencer or DAW.

3 USB TO HOST Port

This Port will connect to a computer.

4 USB FLASH DRIVE Port

This Port will accept a USB Flash Drive.

WHAT MIDI CAN DO ON THE XK-4

The MIDI implementation of the XK-4 allows you to:

- ♦ Use a MIDI keyboard/pedalboard to expand the playing versatility.
- ♦ Control an external sound generator such as a synthesizer or sampler.
- ♦ Record/playback performances to an external sequencer or computer.

For easier access to those settings, the XK-4 is equipped with **MIDI Templates**.

For a fuller explanation of MIDI Templates, see page 132.

USB TO HOST

The USB TO HOST Port will do the following:

- ♦ Send / receive MIDI data (Keyboard channels; UPPER, LOWER, PEDAL and System Exclusive messages, compliant with USB AUDIO Class 1.0).

tips USB AUDIO CLASS

The XK-4 is compliant with USB AUDIO Class 1, the generic device driver which comes pre-installed on both Windows or Mac OS. This means you can use the USB TO HOST Port to connect the XK-4 to a computer and transmit and receive a MIDI data stream without an exclusive device driver.

MIDI CHANNEL

MIDI information travels along **MIDI Channels**. These channels are similar to television channels, in that they provide a way to transmit and receive MIDI information as well as to differentiate among MIDI information sent to different devices. The current MIDI specification provides for 16 Channels, all of which travel along a single cable.

NOTE: In order for MIDI devices properly to communicate, both the sending and receiving devices must be set to the same MIDI Channel.

USING MIDI CHANNELS IN THIS INSTRUMENT

Keyboard Channel

..... These channels sends or receives performance data of the each Part UPPER, LOWER and PEDAL, or controlling messages.

External Zone Channel

..... These channel sends the messages for controlling the external MIDI devices.

MAIN MIDI MESSAGES

MIDI information is grouped into Channel Messages for each of the 16 MIDI Channels and a System Message which applies to all Channels.

NOTE: See the MIDI IMPLEMENTATION CHART on page 160 for more details.

CHANNEL MESSAGES

The Channel Messages are classified below:

Channels \ Messages	Keyboard	External Zone
Note On / Note Off	Sends or receives performance data (which key, how velocity, on or off) for this instrument.	Sends performance data for external MIDI devices.
Pitch Bend	Controls pitch for this instrument.	Sends pitch control for external MIDI devices.
Program Change	Selects a Patch for this instrument.	Selects Program for external MIDI devices.
Control Change	Sends or receives the various control messages for this instrument i.e. Expression, Foot Switches. This includes Bank Select or NRPN.	Sends Control messages for external MIDI devices. This includes Bank Select.

There are special Control Changes also.

Bank Select... This Control Change is for extend the Program Change. For extend Program Change which has only 128 range, the Bank Select has up to 16,384 range. Thus it can be select the 2,097,152 Programs.

NRPN..... The NRPN stands for Non Registered Parameter Number. The normal Control Change has only 128 kinds. The NRPN can be control exclusively device parameters up to 16,384 kinds.

tips NRPN OR SYSTEM EXCLUSIVE MESSAGE?

There are two ways to sets a exclusively parameter of this instrument, NRPN or System Exclusive Message (hereinafter, SysEx).

The NRPN depends by MIDI channel for selecting the individual unit, and it can recorded on the track in the MIDI sequencer or DAW, directly.

The SysEx uses ID for selecting the individual unit regardless of MIDI channel. But some MIDI sequencer or DAW does not support send on real time, or nothing support for it.

SYSTEM MESSAGES

◆ SYSTEM EXCLUSIVE MESSAGES

These are messages which are unique to a particular manufacturer or between instruments of the same model from the same manufacturer.

This instrument uses System Exclusive Message for the following:

Memory Dump

..... Transmits the current status of this instrument and it can be recorded on the external MIDI sequencer or DAW.

Data Set

..... Set a exclusively parameter of this instrument. It is short message relatively.

MIDI STRUCTURE OF THE XK-4

The XK-4 can transmit and receive MIDI data on **Keyboard Channels** as well as transmit MIDI data on **External Zones**. The following illustrations and paragraphs explain this in more detail.

Map of the MIDI structure of the XK-4

Non-Keyboard Extended

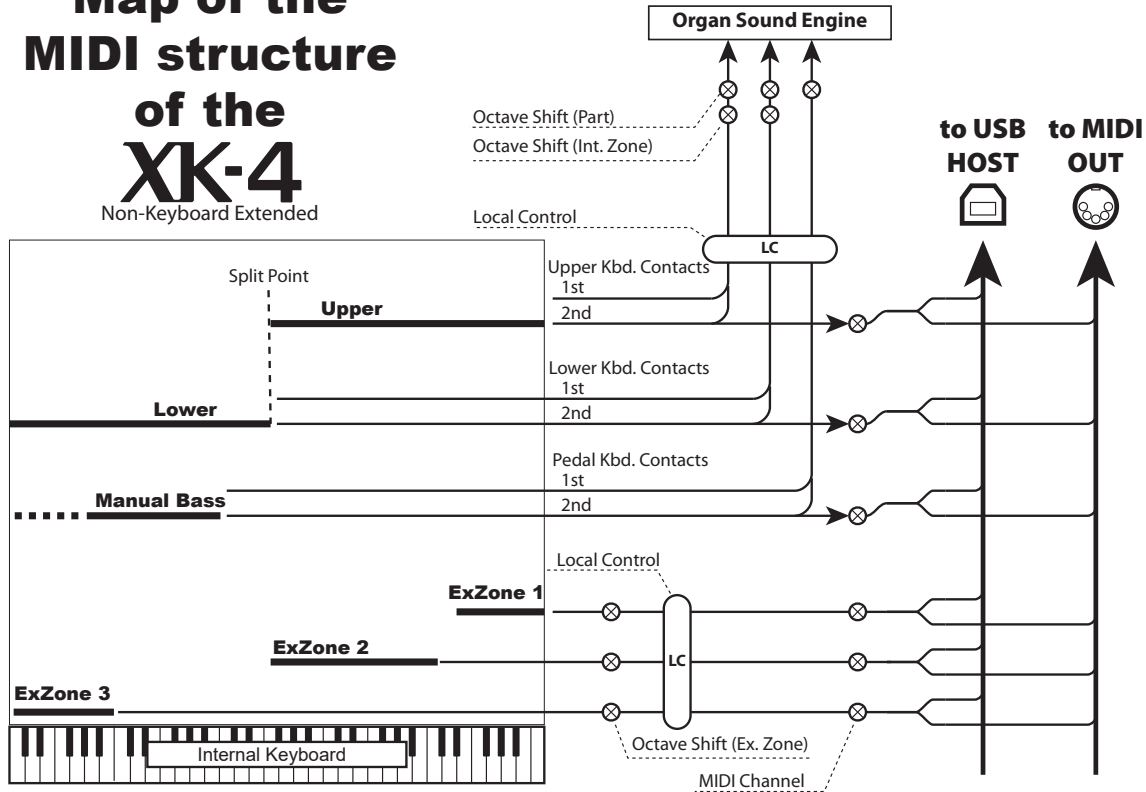

KEYBOARD (INTERNAL) CHANNELS

The internal sounds of the instrument will play on what are called the **Keyboard** or **Internal Channels**.

The Keyboard Channels transmit Note On/Note Off and Velocity data from the UPPER, LOWER and PEDAL Keyboards. These channels will both send (MIDI OUT) and receive (MIDI IN) data, and are therefore used when recording and playing back sequences.

NOTE: The UPPER Keyboard Channel, in addition to Note On/Note Off and Velocity data, also is used for transmitting Controller data.

EXTERNAL ZONES

The External Zone allow you to use the XK-4 as a MIDI Master Keyboard. These allow you to play additional sounds from another MIDI instrument such as a Sound Module. The External Zones transmit but do not receive MIDI data - in other words, they are MIDI OUT only.

There are three (3) External Zone Channels which can be assigned to the UPPER Manual, LOWER Manual or PEDALS. In addition, different configurations can be Recorded to different Patches - for example, one Patch can have all three External Zones assigned to the UPPER Manual, another Patch can have one External Zone each for UPPER, LOWER and PEDALS, etc.

EXPANDED KEYBOARDS

When MIDI keyboards are used to expand the LOWER and/or PEDAL Parts, they will not only play the internal voices of the XK-4, but also transmit MIDI data to other MIDI devices via the MIDI OUT port. Thus, both the Keyboard Channels and the External Zones will respond from connected MIDI keyboards, as if the Expanded Keyboards were "built-in" as an integral part of the XK-4.

Map of the MIDI structure of the XK-4 Keyboard Extended

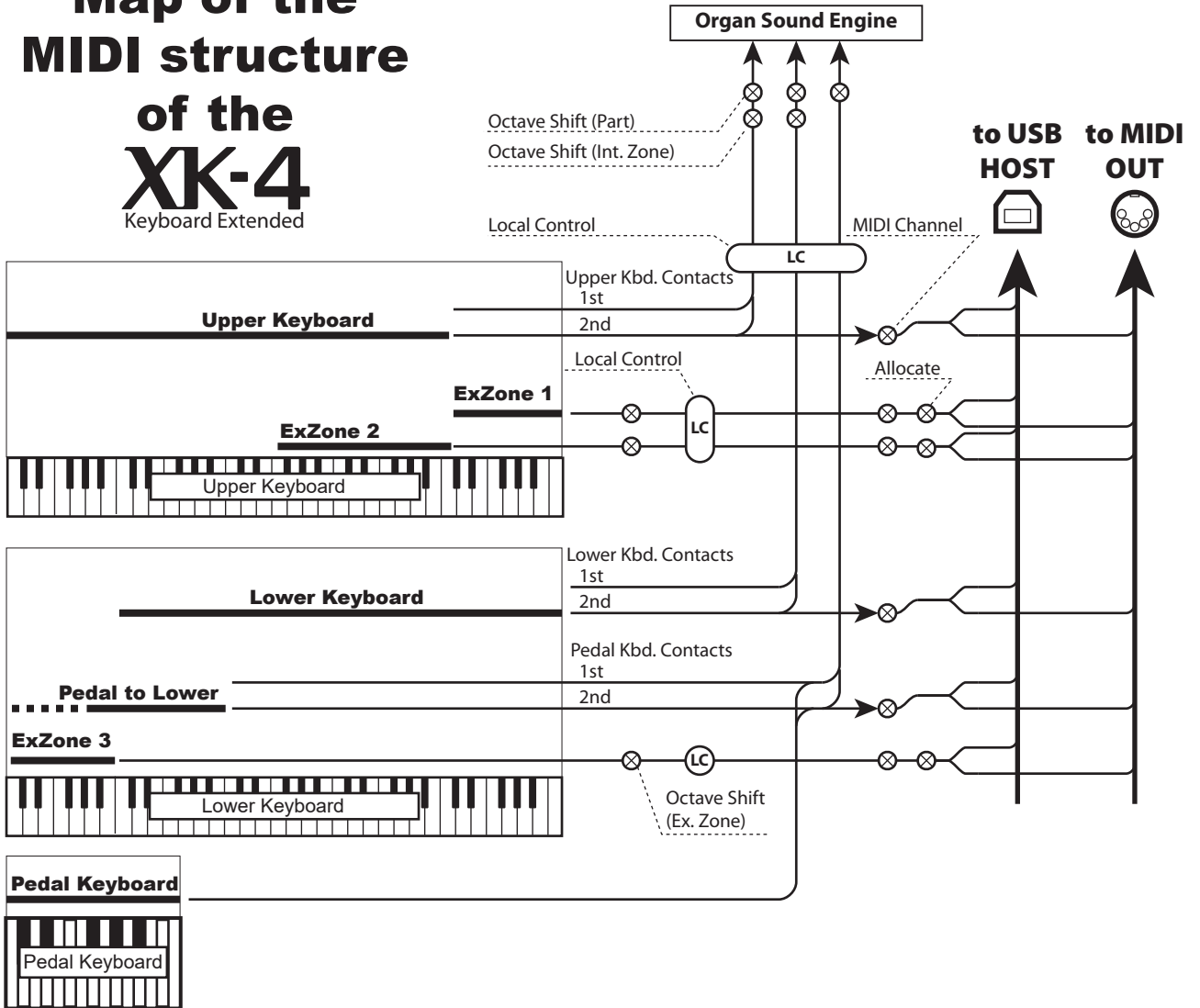

USING AN EXTERNAL SEQUENCER

This section explains how to record and play back a performance on the XK-4 using either an external MIDI sequencer or a computer running a Digital Audio Workstation, or DAW.

RECORDING AND PLAYING BACK A PERFORMANCE

In order to Record and Play a MIDI performance, connect the MIDI cables as shown in the illustration on the right.

RECORD

1. Connect MIDI cables as shown on the right.
2. Go to the MIDI FUNCTION Mode and select the MIDI Template appropriate for your system. You can select "Basic", "2 Man Lower", "2 Man Upper", "Pedal KBD", "3 KBD Lower" or, "3 KBD Upper."

NOTE: This connection cannot record MIDI data sent via External Zones.

3. Configure the MIDI Channels on your sequencer or DAW. If you are recording the UPPER Keyboard only, set the MIDI Channel on your sequencer to record Channel "1." To record all keyboards, set your sequencer to record Channels "1," "2" and "3." (UPPER=1, LOWER=2 and PEDAL=3).
4. Start recording on your sequencer or DAW.
5. If you need to send System Exclusive data, etc., transmit a MIDI Memory Dump.
6. Start your performance.

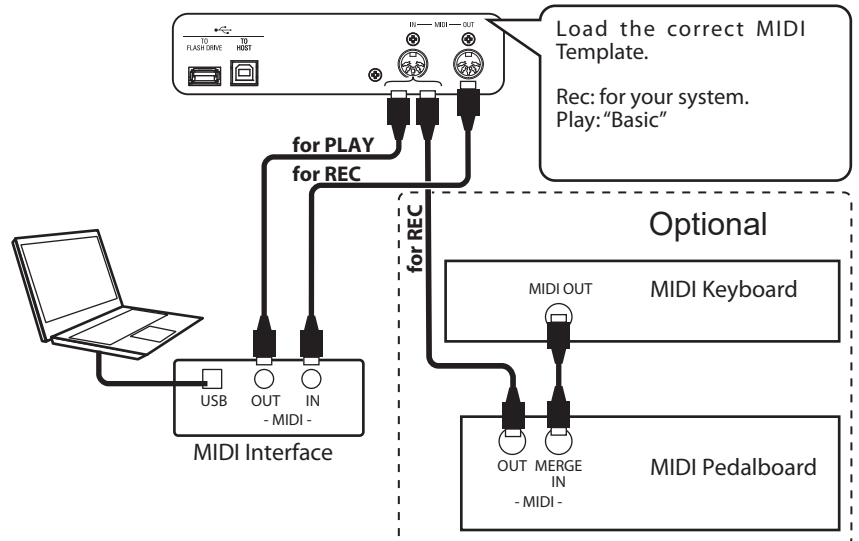

PLAYBACK

1. Make the connections as shown in the figure above for Playback.
2. Select and Load the "Basic" MIDI Template (see page 132).
3. Start playback of the sequence.

RECORDING A PERFORMANCE VIA USB CABLE

The USB MIDI connection will allow you to Record and Play sequences with only one cable connection and no MIDI interface between the computer and the XK-4 as shown on the right.

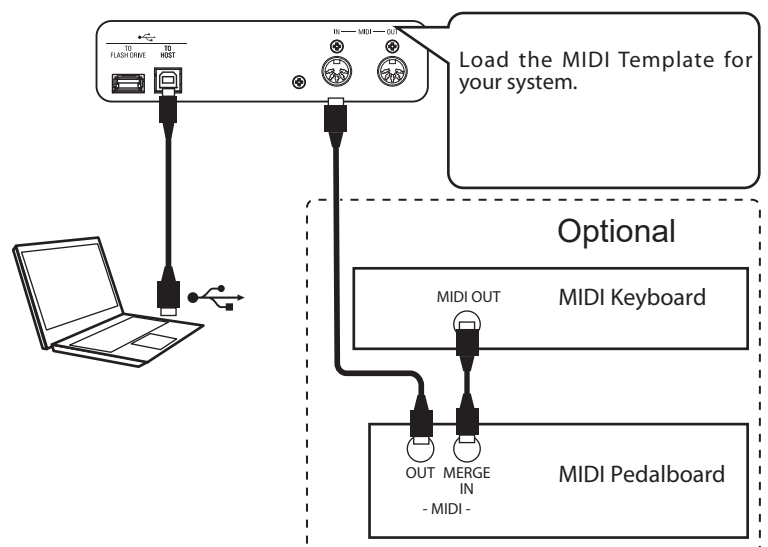

To control a MIDI Sound Module from the XK-4 using both a single keyboard and Expanded Keyboards, do the following:

BASIC CONNECTIONS

1. CONNECT THE MIDI MODULE

Connect the MIDI OUT of the XK-4 to the MIDI IN of the MIDI Sound Module.

2. LOAD THE "EXZ..." MIDI TEMPLATE (P. 132)

This MIDI Template mutes the Keyboard Channels. If you want also to transmit MIDI data on the Keyboard Channels, you must turn them "ON" manually. See page 133 "MIDI Channels" for instructions on how to do this.

3. SET THE ZONES AND RECORD THE SETTINGS TO THE PATCH.

Please refer to page 89 "EXTERNAL ZONES" for instructions on how to set Zones.

SIMPLIFIED SETUP

This procedure described below allows you to transmit MIDI data without using the External Zones.

1. CONNECT A MIDI MODULE

Connect the MIDI OUT of the XK-4 to the MIDI IN of the MIDI Sound Module.

2. LOAD THE MIDI TEMPLATE FOR YOUR SYSTEM (P. 132).

Select the MIDI Template to Load (Basic, Lower, Lower+Pedal, etc.) depending upon whether you are using Expanded Keyboards.

3. TURN OFF UNUSED MIDI MESSAGES (P. 132).

Turn MIDI messages for controlling INDIVIDUAL, PROGRAM CHANGE, and DB REGISTRATION "OFF." These messages are not used in this setup.

4. MATCH THE MIDI CHANNELS (P. 133).

Match the MIDI Channels between the Keyboard Channels of the XK-4 and the MIDI Sound Module.

NOTE: In this setup, "Sounding Range" and "Program Change" cannot be changed by a Patch. Also, "Note Velocity" is transmitted by the raw value of the keyboard and cannot be adjusted.

NOTE: Use the EXTERNAL ZONES or BASIC CONNECTIONS of this page if you want to send desired "Sounding Range", "Program Change", "Note Velocity" and so on.

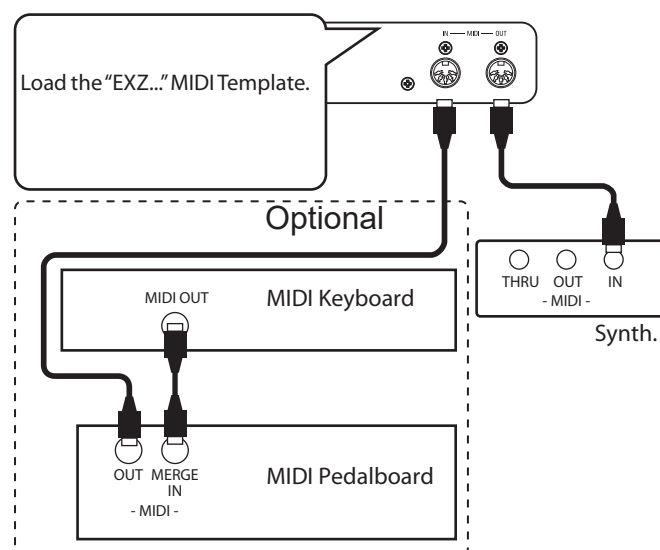

tips SOUNDING POINT OF THE EXTERNAL ZONES

When keys are depressed, the sounding point of the External Zones is deeper than that of the internal sounds.

RECORDING TO A SEQUENCER OR DAW

USING THE MIDI PORTS

Load the “EXZ...” MIDI Template.

This MIDI Template mutes the Keyboard Channels. If you want also to transmit MIDI data on the Keyboard Channels, you must turn them “ON” manually. See page 133 “MIDI Channels” for instructions on how to do this.

Record both Keyboard Channels and External Zone Channels to the sequencer or DAW.

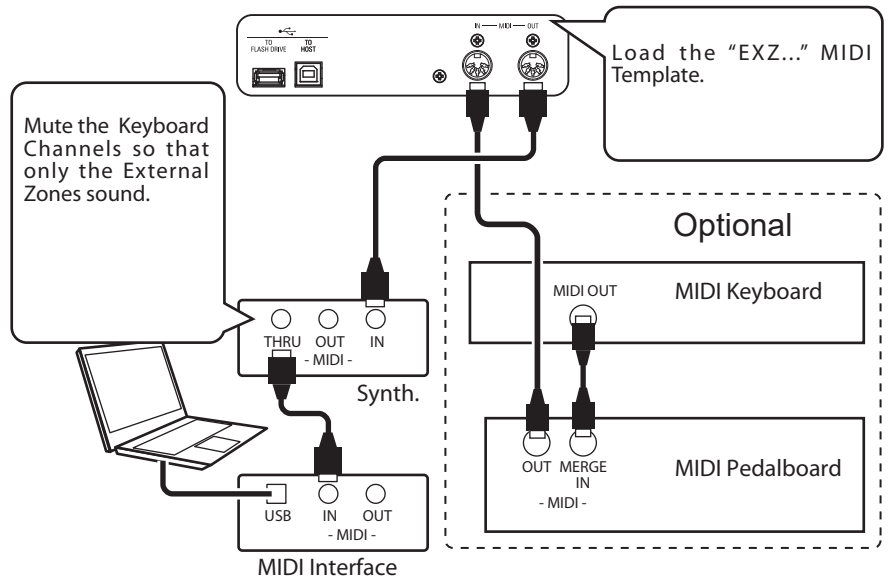

Set the Local Control of the XK-4 at “ON,” and Echo of the DAW at “OFF.”

PLAY BACK THE PERFORMANCE

You can play back both Keyboard Channels and External Zone Channels from your sequencer or DAW.

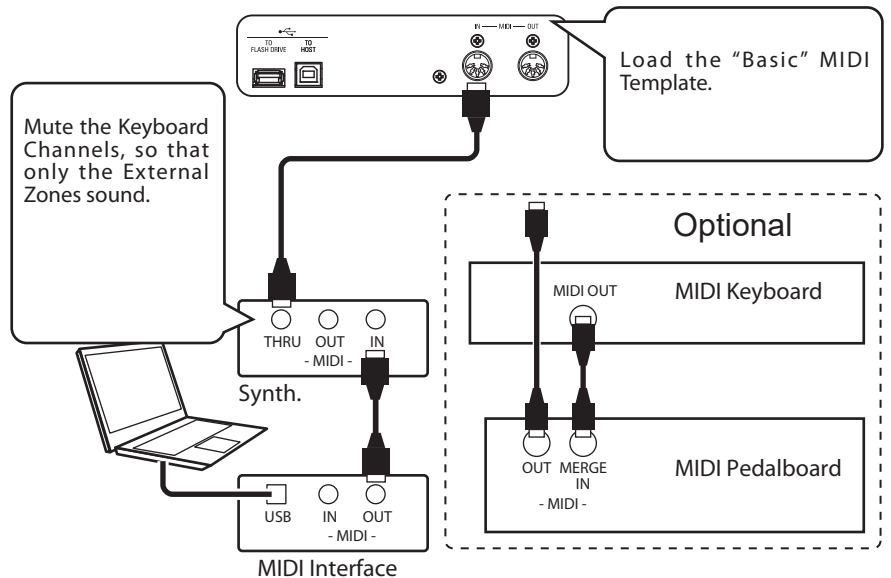

USING USB MIDI

If you want to play the software synthesizer in a PC using both Keyboard Channels and External Zones, do the following:

1. Load the “EXZ...” MIDI Template.
2. The “EXZ...” MIDI template mutes the Keyboard Channels. Therefore, make sure both Transmit and Receive are enabled for the Keyboard Channels.

NOTE: See “MIDI Channels”(P. 133) for instructions on how to enable Transmit and Receive for the Keyboard Channels.

3. Set the Local Control at “ON.”
4. Set the MIDI Echo of the sequencer or DAW at “ON” to sound the software synthesizer.
5. Record both Keyboard Channels and External Zone Channels to the sequencer or DAW.

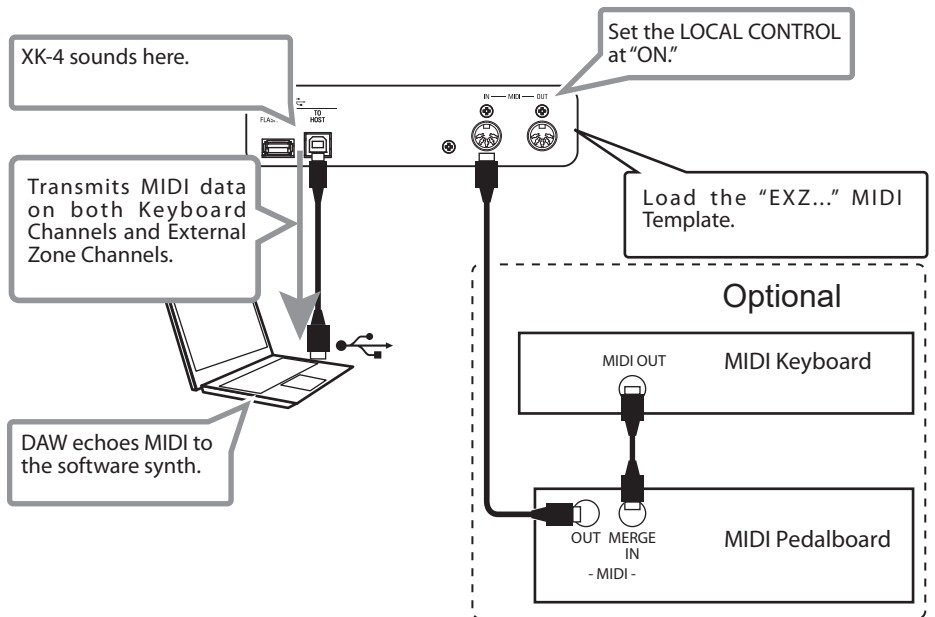

This FUNCTION Mode allows you to adjust the basic MIDI Parameters as well as Send and Receive a MIDI Memory Dump.

TO LOCATE THIS MODE:

[MENU/EXIT] - **SYSTEM** - **MIDI** - [ENTER]

MIDI TEMPLATE

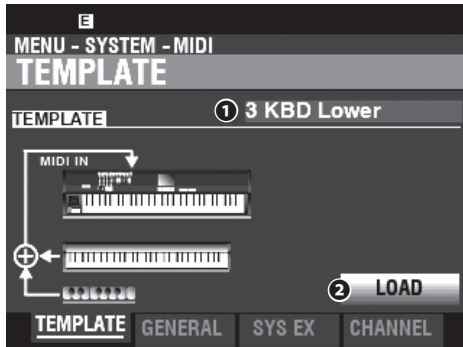

1 MIDI TEMPLATE

This allows you to Load various pre-programmed MIDI settings. To Load a MIDI Template, select **TEMPLATE**, move the cursor to the **LOAD** icon and press the [ENTER] button.

NOTE: For a detailed listing of MIDI Templates, see "MIDI TEMPLATES" starting on page 148.

NOTE: If a MIDI Template is selected and any of the following Parameters are changed, the box to the right of "TEMPLATE" will display, "User Edited."

GENERAL

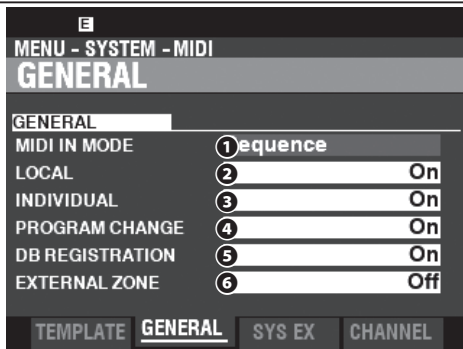

1 MIDI IN

This allows you to select the function of the [MIDI IN] Port.

Sequence

Receives MIDI messages on UPPER, LOWER and PEDAL Parts on their MIDI Channels. MIDI messages will not be re-sent.

Upper / Lower / Pedal

Use this Template to connect a MIDI keyboard as an (UPPER / LOWER / PEDAL) keyboard.

Received MIDI messages will sound the Sections allocated to the (UPPER / LOWER / PEDAL) keyboard ignoring the MIDI Channel, and will re-send to MIDI OUT and USB-MIDI.

Upper + Pedal / Lower + Pedal

Use this Template to connect two MIDI keyboards as (UPPER + PEDAL / LOWER + PEDAL) keyboards.

Received MIDI messages will sound each Part (UPPER, PEDAL / LOWER, PEDAL) by the MIDI keyboards on the assigned MIDI Channels, and re-send to MIDI OUT and USB MIDI.

NOTE: The **SPLIT** does not function when the MIDI IN mode is set at "Upper / Lower," "Lower + Pedal" or "Upper + Pedal."

2 LOCAL CONTROL

Settings: Off, On

This allows you to turn Local Control "ON" or "OFF"

On..... The keyboard plays the internal sounds of the instrument.

Off..... The internal sounds of the XK-4 will not play from the keyboard. Use this setting for recording performance to an external sequencer with a MIDI Echo feature.

3 INDIVIDUAL PARAMETERS

Settings: Off, NRPN, Sys Ex

This sets the way to the transmission the Individual Parameters. Individual Parameters are used for controlling Section Volume, Leslie Fast, etc.

Off..... Does not transmit.

NRPN..... Transmits NRPN (Non-Registered Parameter Number) data (P. 125).

Sys Ex..... Transmits System Exclusive (Sys Ex) data (P. 125).

NOTE: The XK-4 receives Individual Parameters by System Exclusive messages even if this Parameter is not set at "Sys Ex."

NOTE: For a list of Individual Parameters transmitted and recognized by the XK-4, consult MIDI INFORMATION on page 152.

4 PROGRAM CHANGE

Settings: Off, On

This allows you to select whether to transmit and receive Program Change messages for Patches and External Zones.

5 DRAWBAR REGISTRATION

Settings: Off, On

This allows you to select whether to transmit and receive Drawbar Registration.

6 EXTERNAL ZONES

Settings: Off, On

This is a Master On/Off Parameter which allows you to enable or disable MIDI transmission of all External Zones with one setting.

SYSTEM EXCLUSIVE MESSAGES

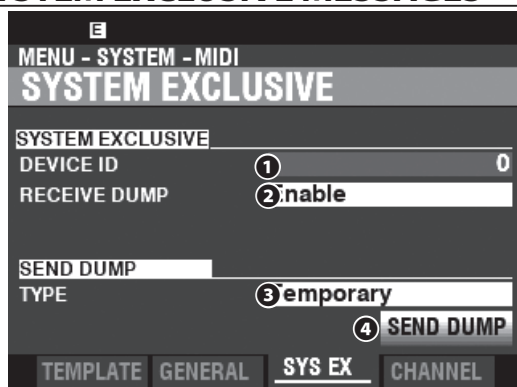

1 DEVICE ID

Setting Range: 0 ~ 127

This allows you to set the Device ID which is used for System Exclusive Messages such as Memory Dump.

2 RECEIVE DUMP

Settings: Disable, Enable

This allows you to Enable or Disable receiving of a Memory Dump.

The XK-4 can transmit several settings as a Memory Dump in a single group. Select "Disable" if you want to prevent internal settings from being changed - for example, if you are playing back songs from an external sequencer or DAW.

Receiving Dump...

The above dialog box will display while a Memory Dump is being received.

3 SEND DUMP TYPE

Settings: Temporary, System

This allows you to adjust which contents will be transmitted by a Memory Dump.

Temporary

Transmits the current status of the Patch parameters of the current Patch and the [MANUAL] (P. 152).

IMPORTANT: If you are recording Sequences, transmit this data before touching any notes or controls so that the registrations for each Section will "match up."

System

Transmits the status of the System Parameters such as controller modes, MIDI Channels (P. 158).

To send a Memory Dump, do the following:

1. Use the DIRECTION [▼] button to move the cursor to the [SEND DUMP] icon.
2. Press the [ENTER] button.

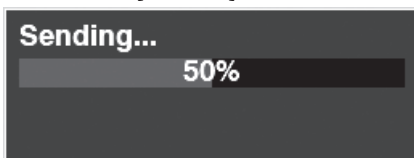

The above dialog box will show while the Memory Dump is sending.

NOTE: If you want to Save the entire contents of the XK-4, save them as a Setup file instead of using a Memory Dump.

MIDI CHANNELS

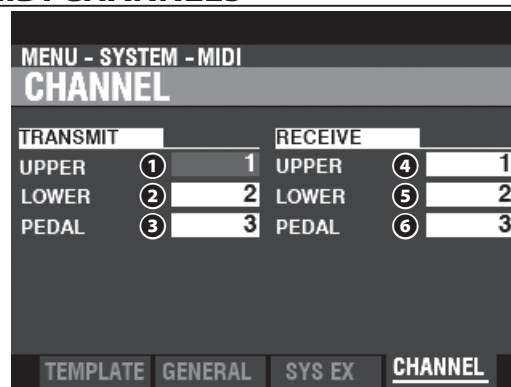

These allow you to select MIDI Channels for transmitting and receiving performance information for each Keyboard.

1 TRANSMIT UPPER, LOWER, PEDAL

Setting Range: 1 ~ 16, Off

This allows you to select the transmitting (Sending) channels for the UPPER, LOWER and PEDAL.

NOTE: These Parameters control the Internal Zones or Keyboard Channels. They do not affect the External Zones.

NOTE: The UPPER Channel sends Controller information such as Pitch Bend, Expression Pedal or NRPN in addition to Note On/Note Off data.

NOTE: To avoid conflicting MIDI messages, set each TRANSMIT Channel and External Zone Channel at different values.

2 RECEIVE UPPER, LOWER, PEDAL

Setting Range: 1 ~ 16, Off

This allows you to select the Receive channels for the UPPER, LOWER and PEDAL.

NOTE: The Parameters in this Mode are System Parameters. You must Record these Parameters if you want their settings to be remembered the next time the instrument is turned "ON." See page 118 for instructions on how to do this.

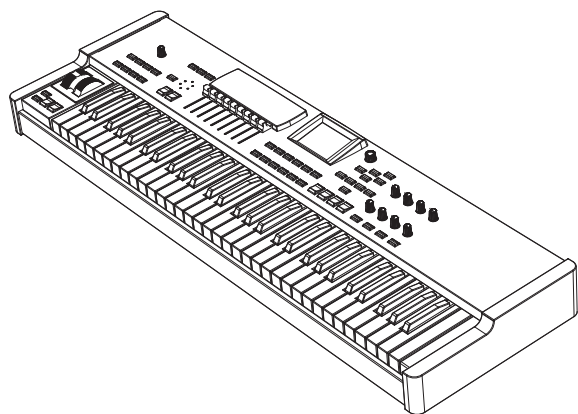

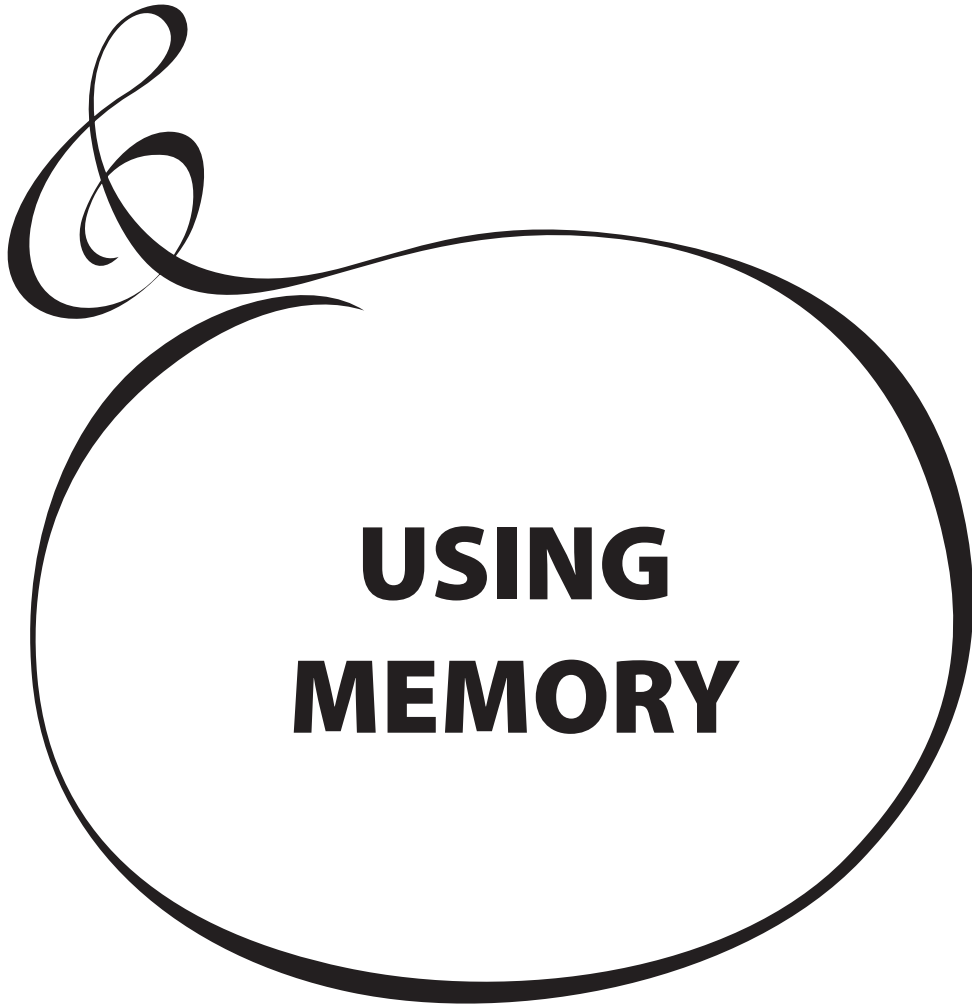
A decorative graphic consisting of a large, stylized ampersand (&) on the left, which curves into a large, thick-lined circle on the right. The circle is empty and serves as a frame for the text.

**USING
MEMORY**

You can Save various contents such as Patches, Custom Settings, etc., as files to a USB Flash Drive.

WHAT YOU CAN DO WITH A USB FLASH DRIVE

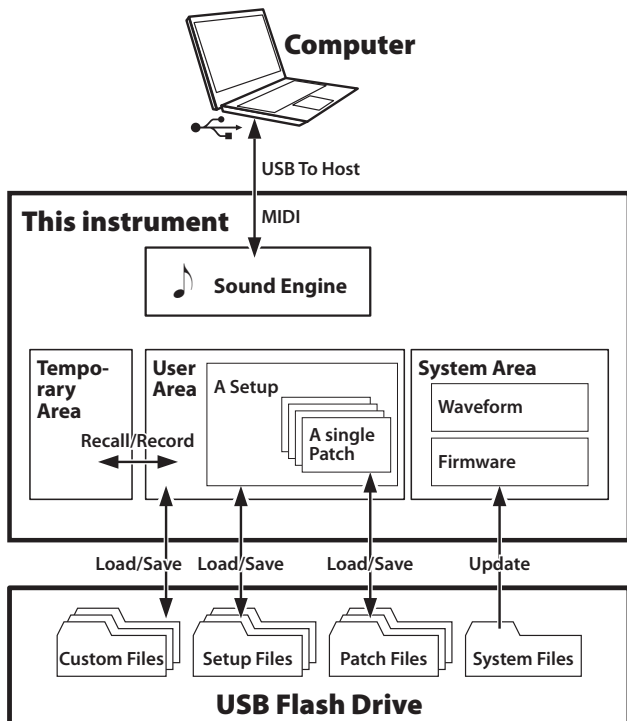
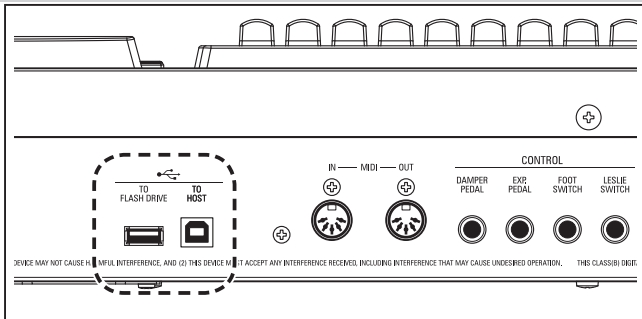

- ◆ Save and Load Setups (see page 138).
- ◆ Save or Load a Patch or Custom Setting.
- ◆ Update the system software.

ABOUT USB FLASH DRIVES

COMPATIBLE USB FLASH DRIVES

There are various types of USB Flash Drives. Generally, a Flash Drive formatted with MS-DOS FAT32 will work.

Consult our website for more information about compatible USB Flash Drives.

In Europe <http://www.hammond.eu>

In the US <https://hammondorganco.com>

USB CONNECTOR

1. Be sure to insert the USB Flash Drive properly.
2. Do not remove the Flash Drive or turn the power "OFF" while working with a USB Flash Drive.

FOLDER STRUCTURE

When the USB Flash Drive is inserted, the following folders are automatically created on the drive.

```

\hammond
  \xk-4
    \custom
      \pipe
        *.cpi
      \twheel
        *.ctw
    \patch
      *.opt
    \setup
      *.set
    \system
      *.bin
  
```

setup

Setup files are saved to this Folder

system

Copy software update files to this Folder.

NOTE: There is an "affinity" between USB Flash Drives and this keyboard, and not all Flash Drives are compatible. To confirm whether a particular Flash Drive will work with the XK-4, see MENU - SYSTEM - INFORMATION - IS ACTIVE - USB FLASH DRIVE (P. 120).

tips FILE NUMBER LIMIT

A Folder can contain up to 256 files.

tips FILE NAME EXTENSIONS

- set Setup File
- opt Organ Patch
- ctw Custom Tone Wheels
- cpi Custom Pipes

This FUNCTION Mode allows you to format a USB Flash Drive for use with the XK-4.
NOTE: Formatting a USB Flash Drive erases all data on the drive. Therefore, be sure to use either a new Drive or one which does not already have data you want to keep.

① INSERT A USB FLASH DRIVE

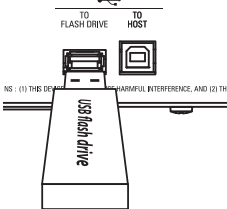

Turn the power to the XK-4 “ON” and insert a USB Flash Drive to the [TO FLASH DRIVE] Port. The message, “Confirming USB...” will display for approximately 1 second. Please wait for this message to disappear.

② LOCATE THE FORMAT PAGE

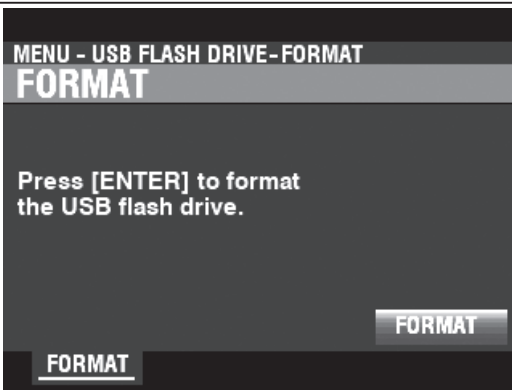

[MENU/EXIT] - **USB FLASH DRIVE - FORMAT** - [ENTER].

③ FORMAT THE USB FLASH DRIVE

Press the [ENTER] button.

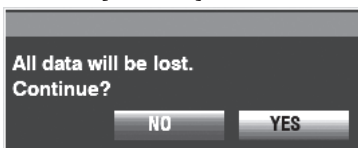

The dialog box for confirmation will shown.

Move the cursor to the [YES] icon by DIRECTION buttons and press the [ENTER] button.

NOTE: If you DO NOT wish to Format, press the [MENU/EXIT] or [PLAY] button instead of the [ENTER] button. Or, select the [NO] icon and press the [ENTER] button.

The message, “Formatting” will display and the formatting process begins. The time necessary to Format a USB Flash Drive may differ depending on the capacity of the Drive, but typically it will be approximately 1 or 2 seconds.

When the Format has finished, “Completed” will show in the display.

NOTE: Do not turn the power “OFF” or remove the USB Flash Drive during the Formatting procedure.

USING SETUP FILES

As explained elsewhere in this Manual, the XK-4 can be customized in a number of different ways - you can create Custom Settings, create your own Patches, etc. After you have made your changes, you can save your edits as a Setup. In this way you can customize the instrument in several different ways and save each series of edits as a separate Setup.

The illustration below shows the data which can be contained in a Setup file.

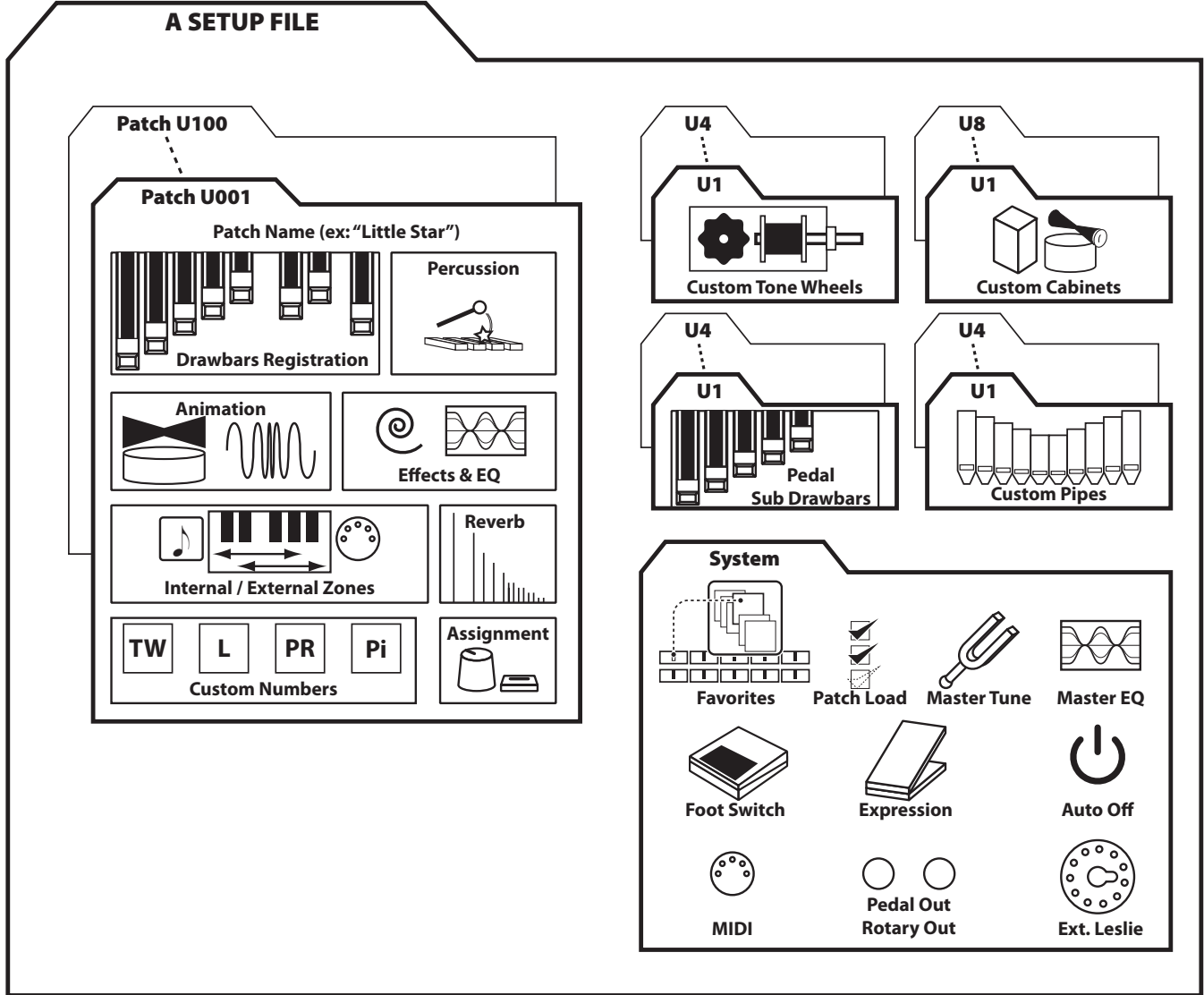

This FUNCTION Mode allows you to Save contents in the XK-4 to a USB Flash Drive.

① INSERT A USB FLASH DRIVE

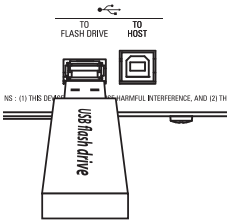

Insert a formatted USB Flash Drive into the [TO FLASH DRIVE] Port.

② LOCATE THE "SAVE" PAGE

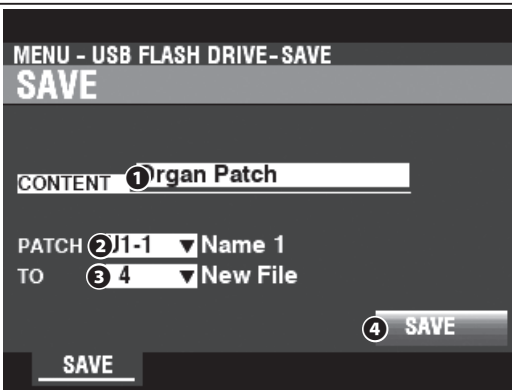

[MENU/EXIT] - USB FLASH DRIVE - SAVE - [ENTER].

③ SELECT THE ITEM TO SAVE

Use the [DIRECTION] buttons and the [VALUE] knob to select the item to Save.

① CONTENT

Select the type of content to Save.

Setup Setup file.

Patch A Patch.

Tone Wheel ... Custom Tone Wheel.

Pipe Custom Pipe.

② FILE

Select the specific file to Save.

③ TO

Select the location to which to Save the selected file. You can either overwrite an existing file or select "New File" to Save your file as a new file.

④ SAVE

Move the cursor to the [SAVE] icon and press the [ENTER] button.

④ NAME THE FILE

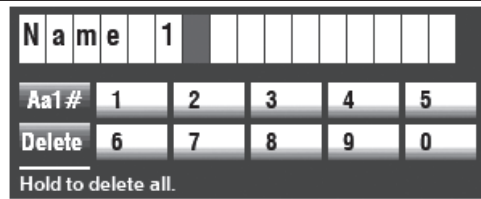

Enter the Name.

[Aa1]..... Changes the character type.

[1] - [10]..... Selects the highlighted character.

[Insert] Inserts a space at the cursor.

[Delete]..... Deletes a letter at the cursor.

[VALUE]..... Changes the letter at the cursor.

After you have finished Naming your file, press the [ENTER] button. The message below will display for approximately 1 second:



NOTE: Do not turn the power "OFF" while the above message is displaying.

NOTE: If you DO NOT wish to Save, press the [MENU/EXIT] button instead of the [ENTER] button.



After pressing the [ENTER] button, the message above will display for approximately 1 second:

⑤ RETURN TO THE PLAY MODE

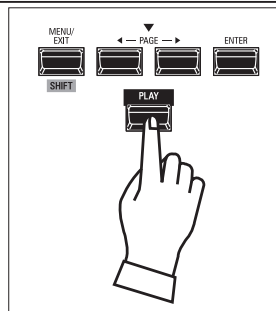

Press the [PLAY] button to return to the PLAY mode.

tips FILE NAMES

The Name you enter will be used as both the File Name (the name shown when viewing the contents of a Folder on a computer) and the content name shown in the display on the instrument.

Also, using "Rename" to give the file a different name on a computer will not change the Name shown in the display on the XK-4.

This FUNCTION Mode allows you to Load files previously Saved to a USB Flash Drive.

① INSERT A USB FLASH DRIVE

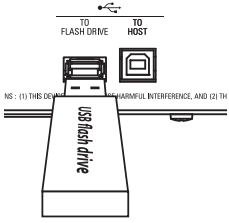

Insert a formatted USB Flash Drive into the [TO FLASH DRIVE] Port.

② LOCATE THE "LOAD" PAGE

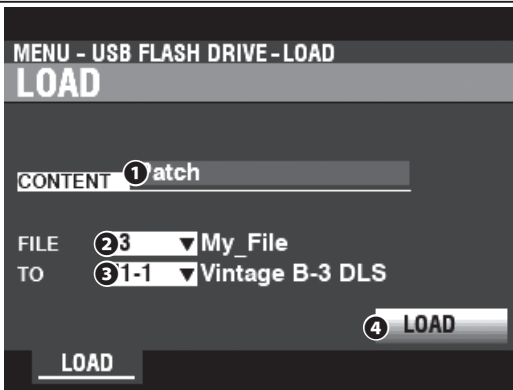

[MENU/EXIT] - USB FLASH DRIVE - LOAD - [ENTER]

③ SELECT THE ITEM TO LOAD

Use the [DIRECTION] buttons and the [VALUE] knob to select the item to Load.

① CONTENT

Select the type of content to Load.

- Setup Setup file.
- Patch Patch.
- Tone Wheel ... Custom Tone Wheel.
- Pipe Custom Pipe.

② FILE

Select the file to Load.

③ TO

Select where to Load the file.

④ LOAD

Move the cursor to the [LOAD] icon and press the [ENTER] button. The message below will display during loading:

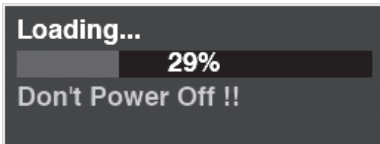

NOTE: Do not turn the power "OFF" while the above message is displaying.

NOTE: If you DO NOT wish to Load, press the [MENU/EXIT] or [PLAY] button instead of the [ENTER] button.

When the display shows:

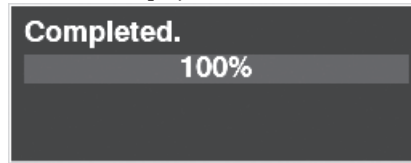

the Loading process is finished.

④ RETURN TO THE PLAY MODE

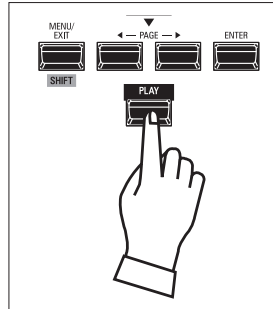

Press the [PLAY] button to return to the PLAY mode.

This FUNCTION Mode allows you to delete content previously saved to a USB Flash Drive.

① INSERT A USB FLASH DRIVE

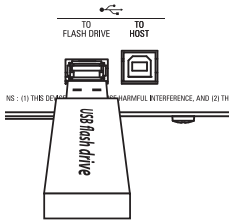

Insert a USB Flash Drive containing files previously Saved from the XK-4 into the [TO FLASH DRIVE] Port.

② LOCATE THE "DELETE" PAGE

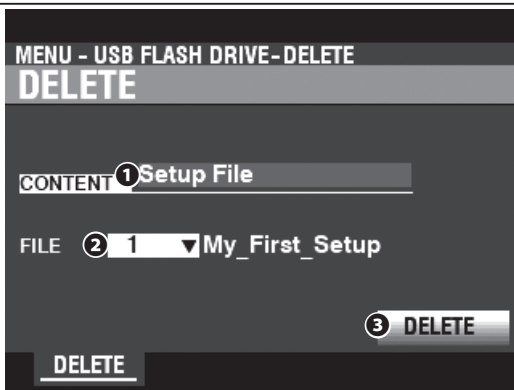

[MENU/EXIT] - USB FLASH DRIVE - DELETE - [ENTER]

③ SELECT THE ITEM TO DELETE

Use the [DIRECTION] buttons and the [VALUE] knob to select the item to Delete.

① CONTENT

Select the type of content to Delete.

- Setup..... Setup file.
- Patch..... Patch.
- Tone Wheel..... Custom Tone Wheel.
- Pipe..... Custom Pipe.

② FILE

Select the file to Delete.

③ DELETE

Move the cursor to the DELETE icon and press the [ENTER] button. The message below will display for approximately 1 second:



NOTE: Do not turn the power "OFF" while the above message is displaying.

NOTE: If you DO NOT wish to Delete, press the [MENU/EXIT] or [PLAY] button instead of the [ENTER] button.

④ RETURN TO THE PLAY MODE

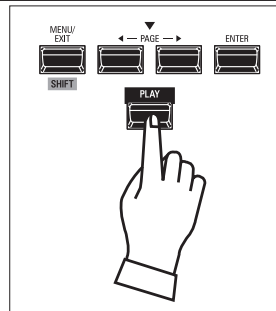

Press the [PLAY] button to return to the PLAY mode.

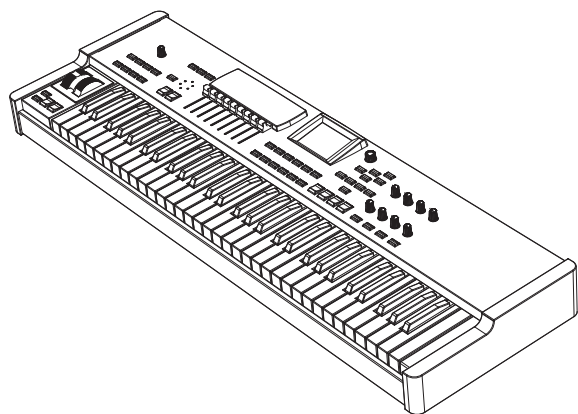



TROUBLESHOOTING

The XK-4 appears complicated; however, most troubles generally can be isolated by observing the operation of the various controls. This is illustrated by the following list of possible troubles, arranged according to their symptoms.

NOTE: It is assumed that the entire instrument plays properly with the exception of the symptoms mentioned.

TROUBLES

- ◆ Entire instrument fails to play.
 - ♦ The [MASTER VOLUME] control is set at minimum. Adjust the [VOLUME] knob.
 - ♦ MIDI Local Control is set to "OFF." Turn the Local Control "ON." ⇒ P. 132.
 - ♦ A Leslie Speaker Cabinet is connected. The sound of the Rotary Channel (Tone Wheel and Transistor Organs) does not appear at the [LINE OUT] or [PHONES] jacks when a Leslie Speaker is connected via the Leslie 11-pin socket.
- ◆ Malfunction of buttons, keys, etc.
 - ♦ Turn the power to the instrument "OFF," then turn it "ON" again. If this procedure is not successful,
 1. Turn the power to the instrument "OFF."
 2. Press and Hold the [RECORD] button.
 3. While holding the [RECORD] button, turn the power to the instrument "ON." All Parameters will return to their factory settings.
- ◆ Expression Pedal does not work.
 - ♦ The EXPRESSION - SOURCE Parameter is not set properly. Set the Parameter for the function you wish. ⇒ P. 109
 - ♦ The Expression Control in the PATCH EDIT - EFFECT/EQ - OVERDRIVE FUNCTION Mode is set at "OD Only" or "Input." Set the Parameter at "Exp. - OD." ⇒ P. 79
 - ♦ The SOURCE setting for a MULTI EFFECT is "Exp." Set the Parameter at one of the other settings. ⇒ P. 76 or 77
- ◆ Foot Switch does not work.
 - ♦ The Parameters for the Foot Switch are not set properly. Check the Parameter settings for the Foot Switch. ⇒ P. 108
- ◆ Foot Switch effect works when the Foot Switch is released instead of depressed.
 - ♦ The Foot Switch Polarity was not detected. Connect the Foot Switch with the power to the XK-4 "OFF" and turn the power "ON" without depressing the Foot Switch. ⇒ P. 108
- ◆ [MENU/EXIT] and/or [RECORD] buttons do not work.
 - ♦ The display is Locked. Unlock the display. ⇒ P. 55

ERROR MESSAGES

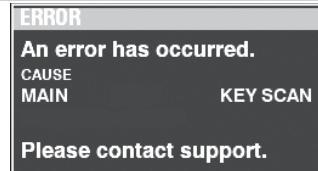

If the above message displays, please consult your authorized Hammond Dealer.



If the above message displays after the instrument is first turned "ON," one or more files necessary for operation of the instrument is missing. You can identify the missing file(s) with MENU - SYSTEM - INFORMATION. The missing file(s) will display "---" instead of a version number.

Prepare a USB Flash Drive with the missing update files and complete the system update. Press the [ENTER] button with the [UPDATE] icon highlighted to start the Update procedure.



APPENDIX

FACTORY PATCHES

Patch #	Category	Name
F1-1	Showcase	Vintage B-3 DLS
F1-2	Showcase	Vintage B-3 Solo
F1-3	Showcase	Classic Gospel
F1-4	Showcase	Vintage B-3 Spenc
F1-5	Showcase	Contemporary Gospel
F1-6	Showcase	Vx Reeds
F1-7	Showcase	String Ens Farf
F1-8	Showcase	Principal Chorus
F1-9	Showcase	Shout Gospel
F1-10	Showcase	Vintage B-3 Power 1
F2-1	Showcase	Vintage B-3 JOS
F2-2	Showcase	Vintage B-3 Squabble
F2-3	Showcase	Purple
F2-4	Showcase	Emerson
F2-5	Showcase	Vintage B-3 Classic Rock
F2-6	Showcase	Vintage B-3 LG
F2-7	Showcase	DB 16' 8' 4'
F2-8	Showcase	Tibia & Vox
F2-9	Showcase	Lee Bee
F2-10	Showcase	Vintage B-3 Power 2
F3-1	DB Tibia	DB 8' & 4'
F3-2	DB Tibia	DB 8' & 2'
F3-3	DB Tibia	DB 8' & 1'
F3-4	DB Tibia	DB 8' 4' 2'
F3-5	DB Tibia	DB 16' & 8'
F3-6	DB Tibia	DB 16' & 4'
F3-7	DB Tibia	DB 16' 8' & 2'
F3-8	DB Tibia	DB 16' 8' 4' & 2'
F3-9	DB Tibia	DB 16' 8' 4' 2' & 1'
F3-10	DB Tibia	DB Full Organ
F4-1	Rock	Vintage B-3 Rock
F4-2	Rock	Jerry C
F4-3	Rock	Booker
F4-4	Rock	Vintage B-3 Clean
F4-5	Rock	Vintage B-3 Stomp
F4-6	Rock	Vintage B-3 OD on Mod
F4-7	Rock	96-Farf
F4-8	Rock	Vintage B-3 Full 1
F4-9	Rock	Vintage B-3 Full 2
F4-10	Rock	Full Overdrive
F5-1	Rock	Principal Chorus + Mixture
F5-2	Classic Pipe	Flute Chorus
F5-3	Classic Pipe	Gamba Celeste
F5-4	Classic Pipe	Sesquialtera II
F5-5	Classic Pipe	Stopped Flute
F5-6	Classic Pipe	Diapason 8' & 4'
F5-7	Classic Pipe	Bourdon 16' & Principal 2'
F5-8	Classic Pipe	Flutes w/Tremulant
F5-9	Classic Pipe	Hautbois Solo
F5-10	Classic Pipe	Sforzando

Patch #	Category	Name
F6-1	Theatre Pipe	Tibia 8'
F6-2	Theatre Pipe	Tibias 8' & 4'
F6-3	Theatre Pipe	Style D Trumpet Solo
F6-4	Theatre Pipe	Oboe 8' & Tibia 4'
F6-5	Theatre Pipe	Tibias 16' & 4'
F6-6	Theatre Pipe	Brass Trumpet Solo
F6-7	Theatre Pipe	Strings & Boxes
F6-8	Theatre Pipe	Tibia 16' 8' 2' & Vox
F6-9	Theatre Pipe	Full Tibias & Voxes
F6-10	Theatre Pipe	Full Comb & Posthorn
F7-1	Lo & Hi	Lo & Hi 1
F7-2	Lo & Hi	Lo & Hi 2
F7-3	Lo & Hi	Lo & Hi 3
F7-4	Lo & Hi	Odd Harmonic
F7-5	Lo & Hi	Pop Solo
F7-6	Lo & Hi	Cute Solo
F7-7	Lo & Hi	Perc 16' & 4'
F7-8	Lo & Hi	Solo 16' & 2'
F7-9	Lo & Hi	Solo 16' & 1'
F7-10	Lo & Hi	Full Hammond
F8-1	Pop	Sylvia
F8-2	Pop	Lady
F8-3	Pop	Yeh Yeh
F8-4	Pop	Season Time
F8-5	Pop	On a Clear Day
F8-6	Pop	Twee motten
F8-7	Pop	Tocatta Live
F8-8	Pop	Je t'aime moi non plus
F8-9	Pop	Early Bird
F8-10	Pop	Bluesette
F9-1	Vx	Vx Mellow
F9-2	Vx	Vx Bright
F9-3	Vx	Vx Mixture
F9-4	Farf	Farf Flute
F9-5	Farf	Farf Brass
F9-6	Farf	Farf Reeds
F9-7	Farf	Farf Strings
F9-8	Farf	Farf Full
F9-9	Ace	Ace Flute
F9-10	Ace	Ace Strings
F10-1	Contemp	Summer Samba
F10-2	Contemp	Pumping Compress
F10-3	Contemp	Touch Wah
F10-4	Contemp	Pipe Mixture
F10-5	Contemp	California Girl
F10-6	Contemp	Won't Get Fooled
F10-7	Contemp	Master Comp
F10-8	Contemp	Swet Carpet
F10-9	TW Basic	DB Reed
F10-10	TW Basic	DB Diapason

PIPE ORGAN STOPS

#	Pipe Voice
1	C-Open Diapason
2	C-Principal
3	C-Diapason
4	C-Bourdon 1
5	C-Bourdon 2
6	C-Gedeckt
7	C-Rohr Flute
8	C-Flute Hamonic
9	C-Flautino
10	C-Voix Cele II
11	C-Clarinet
12	C-Hautbois
13	C-Oboe
14	C-Vox Humana
15	C-Trompette
16	C-Cornet V
17	C-Mixture III
18	C-Mixture IV
19	C-Susquialtera II
20	C-Reserved 1
21	C-Reserved 2
22	T-Tibia Clausa
23	T-Brass Saxophone
24	T-Brass Trumpet
25	T-Clarinet
26	T-English PostHorn
27	T-Orchestral Oboe
28	T-Style D Trumpet
29	T-Viol d'Orchestre
30	T-Vox Humana
31	T-Viol Celeste
32	T-Reserved 1
33	T-Reserved 2
34	P-ConVln 32' & Brdn 16'
35	P-ConBmb 32' & Prn 16'
36	P-ConBrdn 32' & Flte 16'
37	P-Trompette 16'
38	P-Fagott 16'
39	P-SubBs 16' & Gedeckt 8'
40	P-Diapason 8' & Flute 4'
41	P-PrnChors 8' + Mixt IV
42	P-Tibia 16' & Flute 8'
43	P-Diap 16' & PostHorn
44	P-Cornocean
45	P-Reserved 1
46	P-Reserved 2

C Classical
T Theatre
P Pedal

MIDI TEMPLATES

MIDI TEMPLATES

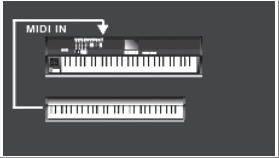
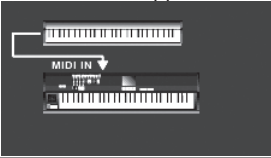
Template		Basic	2 Man Lower	2 Man Upper
				
Messages	MIDI IN	Sequence	Lower	Upper
	Local Control	On	On	On
	NRPN	On	On	On
	Program Change	On	On	On
	Drawbar Registration	On	On	On
	External Zone	Off	Off	Off
Transmit Channel	Tx. Upper	1	1	1
	Tx. Lower	2	2	2
	Tx. Pedal	3	3	3
	Rx. Upper	1	1 (disregarded, off)	1 (disregarded, off)
	Rx. Lower	2	2 (disregarded, off)	2 (disregarded, off)
	Rx. Pedal	3	3 (disregarded, omni)	3 (disregarded, omni)
Comments		Record and Playback between the XK-4 (stand alone) and external sequencer.	Play with expanded LOWER Keyboard connected to the MIDI IN Port. (*1) Your performance will be transmitted from the MIDI OUT Port and recorded by an external sequencer.	Play with expanded UPPER Keyboard connected to the MIDI IN Port. Same as (*1).

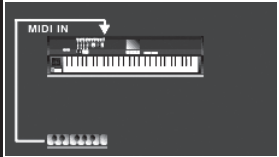
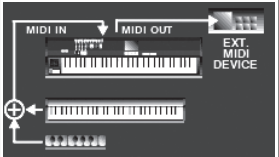
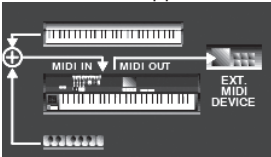
Template		Pedal KBD	3 KBD Lower	3 KBD Upper
				
Messages	MIDI IN	Pedal	Low + Ped	Up + Ped
	Local Control	On	On	On
	NRPN	On	On	On
	Program Change	On	On	On
	Drawbar Registration	On	On	On
	External Zone	Off	Off	Off
Transmit Channel	Tx. Upper	1	1	1
	Tx. Lower	2	2	2
	Tx. Pedal	3	3	3
	Rx. Upper	1 (disregarded, off)	1	1
	Rx. Lower	2 (disregarded, off)	2	2
	Rx. Pedal	3 (disregarded, omni)	3	3
Comments		Play with expanded Pedalboard connected to the MIDI IN Port. Same as (*1).	Play with both expanded LOWER Keyboard (Ch. 2) and Pedalboard (Ch. 3) connected to the MIDI IN Port. Same as (*1).	Play with both expanded UPPER Keyboard (Ch. 1) and Pedalboard (Ch. 3) connected to the MIDI IN Port. Same as (*1).

Template		EXZ	EXZ 2 Man Lower	Ex 2 Man Upper
Messages	MIDI IN	Sequence	Lower	Upper
	Local Control	On	On	On
	NRPN	On	On	On
	Program Change	On	On	On
	Drawbar Registration	On	On	On
	External Zone	On	On	On
Transmit Channel	Tx. Upper	Off	Off	Off
	Tx. Lower	Off	Off	Off
	Tx. Pedal	Off	Off	Off
	Rx. Upper	Off	Off	Off
	Rx. Lower	Off	Off	Off
Comments		Off	Off	Off
	(*2) Control the MIDI equipment by using External Zones and MIDI OUT Port.		Play with expanded LOWER Keyboard connected to the MIDI IN Port. Same as (*2).	Play with expanded UPPER Keyboard connected to the MIDI IN Port. Same as (*2).

Template		EXZ Pedal KBD	EXZ 3 KBD Lower	EXZ 3 KBD Upper
Messages	MIDI IN	Pedal	Low + Ped	Up + Ped
	Local Control	On	On	On
	NRPN	On	On	On
	Program Change	On	On	On
	Drawbar Registration	On	On	On
	External Zone	On	On	On
Transmit Channel	Tx. Upper	Off	Off	Off
	Tx. Lower	Off	Off	Off
	Tx. Pedal	Off	Off	Off
	Rx. Upper	1 (disregarded, off)	1	1
	Rx. Lower	2 (disregarded, off)	2	2
Comments		3 (disregarded, omni)	3	3
	Play with expanded Pedalboard connected to the MIDI IN Port. Same as (*2).		Play with both expanded LOWER Keyboard (Ch. 2) and Pedalboard (Ch. 3) connected to the MIDI IN Port. Same as (*2).	Play with both expanded UPPER Keyboard (Ch. 1) and Pedalboard (Ch. 3) connected to the MIDI IN Port. Same as (*2).

MIDI IMPLEMENTATION

CHANNEL VOICE MESSAGES

Note Off

Status	2nd Byte	3rd Byte
8nH	kkH	vvH, or
9nH	kkH	00H
n=MIDI Channel Number:	0H - FH (Ch. 1 - 16)	
kk=Note Number:	00H - 7FH (0 - 127)	
vv=Velocity (disregard):	00H - 7FH (0 - 127)	

Note On

Status	2nd Byte	3rd Byte
9nH	kkH	vvH
n=MIDI Channel Number:	0H - FH (Ch. 1 - 16)	
kk=Note Number:	00H - 7FH (0 - 127)	
vv=Velocity:	00H - 7FH (0 - 127)	

Control Change

Bank Select (CC#0, 32)

Status	2nd Byte	3rd Byte
BnH	00H	mmH
BnH	20H	llH
n=MIDI Channel Number:	0H - FH (Ch. 1 - 16)	
mm,ll=Bank Number:	00H 00H = User 01H 00H = Factory 64H 00H - 6DH 00H = Bank [1] to [10]	

Modulation (CC#1)

Status	2nd Byte	3rd Byte
BnH	0BH	vvH
n=MIDI Channel Number:	0H - FH (Ch. 1 - 16)	
vv=Modulation:	00H - 7FH (0 - 127)	

Volume (CC#7)

Status	2nd Byte	3rd Byte
BnH	07H	vvH
n=MIDI Channel Number:	0H - FH (Ch. 1 - 16)	
vv=Volume:	00H - 7FH (0 - 127)	
<i>Controls Patch Volume.</i>		

Expression (CC#11)

Status	2nd Byte	3rd Byte
BnH	0BH	vvH
n=MIDI Channel Number:	0H - FH (Ch. 1 - 16)	
vv=Expression:	00H - 7FH (0 - 127)	

Spring Shock (CC#48)

Status	2nd Byte	3rd Byte
BnH	30H	vvH
n=MIDI Channel Number:	0H - FH (Ch. 1 - 16)	
vv=Velocity:	00H - 7FH (0 - 127)	

TW Brake (CC#49)

Status	2nd Byte	3rd Byte
BnH	31H	vvH
n=MIDI Channel Number:	0H - FH (Ch. 1 - 16)	
vv=Control Value:	00H - 7FH (0 - 127) 0 - 63=Off, 64 - 127=On	

Damper (CC#64)

Status	2nd Byte	3rd Byte
BnH	40H	vvH
n=MIDI Channel Number:	0H - FH (Ch. 1 - 16)	
vv=Control Value:	00H - 7FH (0 - 127) 0 - 63=Off, 64 - 127=On	

Sustain (CC#69)

Status	2nd Byte	3rd Byte
BnH	45H	vvH
n=MIDI Channel Number:	0H - FH (Ch. 1 - 16)	
vv=Control Value:	00H - 7FH (0 - 127) 0 - 63=Off, 64 - 127=On	

Activates Sustain on UPPER and LOWER ORGAN Parts.

Leslie Fast (CC#92)

Status	2nd Byte	3rd Byte
BnH	5CH	vvH
n=MIDI Channel Number:	0H - FH (Ch. 1 - 16)	
vv=Control Value:	00H - 7FH (0 - 127) 0 - 63=Off, 64 - 127=On	

This control is receive only.

NRPN MSB/LSB (CC#98, 99)

Status	2nd Byte	3rd Byte
BnH	63H	mmH
BnH	62H	llH
n=MIDI Channel Number:	0H - FH (Ch. 1 - 16)	
mm=upper byte of the Parameter number specified by NRPN		
ll=lower byte of the Parameter number specified by NRPN		

Data Entry (CC#6, 38)

Status	2nd Byte	3rd Byte
BnH	06H	mmH
BnH	26H	llH
n=MIDI Channel Number:	0H - FH (Ch. 1 - 16)	
mm,ll=the value of the Parameter specified by NRPN		

Program Change

Status	2nd Byte
CnH	ppH
n=MIDI Channel Number:	0H - FH (Ch. 1 - 16)
pp=Program Number:	00H - 63H = Patch# 1-1 to 10-10 64H - 6DH = Favo. Number [1] to [10] 7FH = [Manual]

Example of operation

ex: select Patch# F2-6

Bx 00 01 Bx 20 00 Cx 0F (x=UPPER Channel)

ex: select Favorite Bank[2], Number[6]

Bx 00 65 Bx 20 00 Cx 69 (x=UPPER Channel)

ex: select Manual

Cx 7F (x=UPPER Channel)

CHANNEL MODE MESSAGES

All Sounds Off (CC#120)

Status	2nd Byte	3rd Byte
BnH	78H	00H
n=MIDI Channel Number:	0H - FH (Ch. 1 - 16)	

When this message is received, all currently-sounding notes on the corresponding channel will be turned off immediately.

Reset All Controllers (CC#121)

Status	2nd Byte	3rd Byte
BnH	79H	00H
n=MIDI Channel Number:	0H - FH (Ch. 1 - 16)	

When this message is received, the following controllers will be set to their reset values.

Expression: 127, TW Brake: 0, Damper: 0
NRPN: unset; previously set data will not change

All Notes Off (CC#123)

Status	2nd Byte	3rd Byte
BnH	7BH	00H
n=MIDI Channel Number:	0H - FH (Ch. 1 - 16)	

When All Notes Off is received, all notes on the corresponding channel will be turned off. However if Hold 1 or Sostenuuto is ON, the sound will be continued until these are turned off.

DRAWBAR DATA LIST

Part	Control Number								
	16'	5 1/2'	8'	4'	2 2/3'	2'	1 3/5'	1 1/2'	1'
Upper	0CH(12)	0DH(13)	0EH(14)	0FH(15)	10H(16)	11H(17)	12H(18)	13H(19)	14H(20)
Lower	15H(21)	16H(22)	17H(23)	18H(24)	19H(25)	1AH(26)	1BH(27)	1CH(28)	1DH(29)
Pedal	21H(33)	-	23H(35)	-	-	-	-	-	-

Value	Level								
	0	1	2	3	4	5	6	7	8
	00 - 0FH (0 - 15)	10 - 1FH (16 - 31)	20 - 2FH (32 - 47)	30 - 3FH (48 - 63)	40 - 4FH (64 - 79)	50 - 5FH (80 - 95)	60 - 6FH (96 - 111)	70 - 7EH (112-126)	7FH (127)

ex: Set Lower 8' to level 7 via MIDI. Bx 17 70 (x=UPPER Channel)

SYSTEM EXCLUSIVE MESSAGES

MEMORY DUMP

1. Each Packet (139 Bytes)

F0	System Exclusive
55	SUZUKI ID
dd	Device ID (refer to page 133)
10	Model ID MSB
25	Model ID LSB
11	Command: Data Packet
[TYPE]	Data Type 07H, 08H = Temp. Dump 0AH = System Dump
[PNH]	Packet Number MSB
[PNL]	Packet Number LSB
[DATA]	64 Bytes Data 128 Bytes nibblized ASCII ex: 7EH = 37H, 45H
[CHD]	Check Digit Lower 7 bits of XOR [DATA]
F7	End Of Exclusive

2. Acknowledge

F0	System Exclusive
55	SUZUKI ID
dd	Device ID
10	Model ID MSB
25	Model ID LSB
14	Command: Acknowledge
[TYPE]	Data Type
[AK]	Result 00H = OK 05H = Check Digit Error 06H = Receive Protected
[PNH]	Packet Number MSB
[PNL]	Packet Number LSB
F7	End Of Exclusive

3. # of Packets

Temp. Dump: 46
System Dump: 11

DUMP REQUEST (Rx. Only)

F0	System Exclusive
55	SUZUKI ID
dd	Device ID
10	Model ID MSB
25	Model ID LSB
12	Command: Dump Request
[TYPE]	Data Type 07H = Temp. Dump 0AH = System Dump
F7	End Of Exclusive

NRPN SWITCH

F0	Suzuki Exclusive
55	SUZUKI ID
dd	Device ID
10	Model ID MSB
25	Model ID LSB
02	Command: NRPN Sw.
[DATA]	00: Off 01: NRPN 02: Sys Ex
F7	End Of Exclusive

When this device receives this message, switch Tx & Rx Individual Messages in the UPPER channel.

DATA SET

F0	System Exclusive
55	SUZUKI ID
dd	Device ID
10	Model ID MSB
25	Model ID LSB
13	Command: Data Set
aa	Address MSB
bb	Address
cc	Address LSB
[DATA]	Data (Flexible bytes)
F7	End Of Exclusive

IDENTITY REQUEST (RX. ONLY)

F0	System Exclusive
7E	Universal non real-time
dd	Device ID
06	Sub ID #1
01	Sub ID #2
F7	End Of Exclusive

IDENTITY REPLY (TX. ONLY)

F0	System Exclusive
7E	Universal non real-time
dd	Device ID
06	Sub ID #1
02	Sub ID #2
55	SUZUKI ID
00 10	Device Family code
00 25	Device Family number
00 00	
00 00	
F7	End Of Exclusive

When Identity Request is received, Identity Reply will be transmitted.

PATCH PARAMETERS

Category	Parameter	NRPN		SysEx Address			SysEx Length	Data <small>The data length 01 uses only MSB, length 02 uses MSB and LSB.</small>
		MSB (63)	LSB (62)	MSB to LSB				
Name		--	--	--	--	--	--	16 letters
Reverb	On	10	00	00	10	00	01	00, 01 (Off, On)
	Type	10	01	00	10	01	01	00 - 07 00: Room 1 05: Church 01: Room 2 06: Plate 02: Ballroom 07: Spring 03: Hall 1 04: Hall 2
	Depth	10	02	00	10	02	01	00 - 7F (0 - 127)
	Time	10	03	00	10	03	01	00 - 7F (0 - 127)
	Pre-LPF	10	04	00	10	04	01	00 - 7F (0 - 127)
Organ Upper	Octave	24	28	00	24	28	02	3F 7E - 40 00 - 40 02 (-2 - +0 - +2)
	Key Range Low	24	1E	00	24	1E	01	00 - 7F: note number
	Key Range High	24	1F	00	24	1F	01	00 - 7F: note number
	Impedance Reduction	24	0D	00	24	0D	01	00, 01 (Off, On)
Organ Lower	Octave	24	29	00	24	29	02	3F 7E - 40 00 - 40 02 (-2 - +0 - +2)
	Key Range Low	24	21	00	24	21	01	00 - 7F: note number
	Key Range High	24	22	00	24	22	01	00 - 7F: note number
Organ Pedal	Octave	24	2A	00	24	2A	02	3F 7E - 40 00 - 40 02 (-2 - +0 - +2)
	Key Range Low	24	24	00	24	24	01	00 - 7F: note number
	Key Range High	24	25	00	24	25	01	00 - 7F: note number
Internal Zones	Octave Upper	17	00	00	17	00	02	3F 7E - 40 00 - 40 02 (-2 - +0 - +2)
	Octave Lower	17	01	00	17	01	02	3F 7E - 40 00 - 40 02 (-2 - +0 - +2)
	Octave Pedal	17	02	00	17	02	02	3F 7E - 40 00 - 40 02 (-2 - +0 - +2)
	Octave Real Lower	17	03	00	17	03	02	3F 7E - 40 00 - 40 02 (-2 - +0 - +2)
	Split On	17	04	00	17	04	01	00, 01 (Off, On)
	Split Point	17	05	00	17	05	01	00 - 7F: note number
	Pedal to Lower On	17	06	00	17	06	01	00, 01 (Off, On)
	Pedal to Lower Upper Limit	17	07	00	17	07	01	00 - 7F: note number
	Pedal to Lower Mode	17	08	00	17	08	01	00 - 02 (Lowest, Chord, Poly)
	Pedal Key Mono/Poly	17	0B	00	17	0B	01	00, 01 (Mono, Poly)
	Octave Button To ExZ	17	0E	00	17	0E	00	00, 01 (Off, On)
External Zones	On	1n	00	00	1n	00	01	00, 01 (Off, On)
	MIDI Channel	1n	01	00	1n	01	01	00 - 0F (1 - 16)
	Octave	1n	02	00	1n	02	02	3F 7E - 40 00 - 40 02 (-2 - +0 - +2)
	Transpose	1n	03	00	1n	03	02	3F 7A - 40 00 - 40 06 (-6 - +0 - +6)
	Bank Select MSB	1n	04	00	1n	04	01	00 - 7F (0 - 127)
	Bank Select LSB	1n	05	00	1n	05	01	00 - 7F (0 - 127)
	Program Change	1n	06	00	1n	06	01	00 - 7F (0 - 127)
	Allocate	1n	07	00	1n	07	01	00 - 03 (Off, Upper, Lower, Pedal)
	Key Range Low	1n	08	00	1n	08	01	00 - 7F: note number
	Key Range High	1n	09	00	1n	09	01	00 - 7F: note number
	Volume	1n	0A	00	1n	0A	01	00 - 7F (0 - 127)
	Expression Enable	1n	0B	00	1n	0B	01	00, 01 (Off, On)
	P. Bend Enable	1n	0C	00	1n	0C	01	00, 01 (Off, On)
	Mod. Enable	1n	0D	00	1n	0D	01	00, 01 (Off, On)
	Damper Enable	1n	0E	00	1n	0E	01	00, 01 (Off, On)
	Pan	1n	0F	00	1n	0F	01	00 - 40 - 7F (Left - Center - Right)
	Velocity Curve	1n	10	00	1n	10	01	00 - 04 (Off, Hard - Easy)
	Expression Minimum	1n	11	00	1n	11	01	00 - 3F (0 - 63)
	Expression Maximum	1n	12	00	1n	12	01	40 - 7F (64 - 127)
	Expression CC	1n	13	00	1n	13	01	00, 01, 02 (Off, 7, 11)
Control	Pitch Bend Range Up	24	1B	00	24	1B	01	00 - 0C (0 - 12)
	Pitch Bend Range Down	24	1C	00	24	1C	01	00 - 18 (0 - 24)
	Mod. Mode	24	1D	00	24	1D	01	00 - 04 (Off, OD, MFX1, MFX2, Leslie)
	Damper Enable Upper	24	20	00	24	20	01	00, 01 (Off, On)
	Damper Enable Lower	24	23	00	24	23	01	00, 01 (Off, On)
	Damper Enable Pedal	24	26	00	24	26	01	00, 01 (Off, On)

"n" means;
8: Ex Zone 1
9: Ex Zone 2
A: Ex Zone 3

Category	Parameter	NRPN		SysEx Address			SysEx Length	Data The data length 01 uses only MSB, length 02 uses MSB and LSB.
		MSB (63)	LSB (62)	MSB to LSB				
Assignable Control	Button 1	24	17	00	24	17	01	00 - 0A 00: Off 01: Sustain Upper 02: Sustain Lower 03: TW Brake 04: Spring Shock 05: Delay Time 06: Multi Effects 1 07: Multi Effects 2 08 Ext. Zone 1 09: Ext. Zone 2 0A: Ext. Zone 3
	Knob 1	24	18	00	24	18	01	00 - 10 00: Off 01: Multi Effects 1 02: Multi Effects 2 03: Leakage Level 04: Key Click Level 05: VMC Depth 06: Tr. Vibrato Rate 07: Tremulant Rate 08: Tone Control 09: Ext. Zone 1 Vol 0A: Ext. Zone 1 Pan 0B: Ext. Zone 2 Vol 0C: Ext. Zone 2 Pan 0D: Ext. Zone 3 Vol 0E: Ext. Zone 3 Pan 0F: Upper Sus. Len 10: Lower Sus. Len
	Button 2	24	19	00	24	19	01	Same as Button 1
	Knob 2	24	1A	00	24	1A	01	Same as Knob 1

Category	Parameter	NRPN		SysEx Address			SysEx Length	Data
		MSB (63)	LSB (62)	MSB to LSB				
Volume	Patch Volume	24	0C	00	24	0C	01	00 - 7F (0 - 127)
Upper Registration	16'	--	--	00	21	00	01	00 - 08 (0 - 8)
	5 1/3'	--	--	00	21	01	01	00 - 08 (0 - 8)
	8'	--	--	00	21	02	01	00 - 08 (0 - 8)
	4'	--	--	00	21	03	01	00 - 08 (0 - 8)
	2 2/3'	--	--	00	21	04	01	00 - 08 (0 - 8)
	2'	--	--	00	21	05	01	00 - 08 (0 - 8)
	1 3/5'	--	--	00	21	06	01	00 - 08 (0 - 8)
	1 1/3'	--	--	00	21	07	01	00 - 08 (0 - 8)
Lower Registration	16'	--	--	00	22	00	01	00 - 08 (0 - 8)
	5 1/3'	--	--	00	22	01	01	00 - 08 (0 - 8)
	8'	--	--	00	22	02	01	00 - 08 (0 - 8)
	4'	--	--	00	22	03	01	00 - 08 (0 - 8)
	2 2/3'	--	--	00	22	04	01	00 - 08 (0 - 8)
	2'	--	--	00	22	05	01	00 - 08 (0 - 8)
	1 3/5'	--	--	00	22	06	01	00 - 08 (0 - 8)
	1 1/3'	--	--	00	22	07	01	00 - 08 (0 - 8)
Pedal Registration	16'	--	--	00	23	00	01	00 - 08 (0 - 8)
	8'	--	--	00	23	01	01	00 - 08 (0 - 8)
Lower and Upper	Organ Type	24	00	00	24	00	01	00 - 04 00: Tone Wheel 01: Vx 02: Farf 03: Ace 04: Pipe
	Key Click Level	24	01	00	24	01	01	00 - 7F (0 - 127)
	Leakage Level	24	02	00	24	02	01	00 - 7F (0 - 127)
	Custom TW	24	03	00	24	03	01	00 - 07 (U1 - F4)
	Custom Pipe	24	04	00	24	04	01	00 - 07 (U1 - F4)
	Tone Control	24	05	00	24	05	01	00 - 09 - 12 (-9 - ±0 +9)
	VMC Mode	24	06	00	24	06	01	00, 01 (Random, Velocity)
	VMC Depth	24	07	00	24	07	01	00 - 7F (0 - 127)
	Sustain Upper On	24	08	00	24	08	01	00, 01 (Off, On)
	Sustain Upper Length	24	09	00	24	09	01	00 - 04 (1 - 5)
	Sustain Lower On	24	0A	00	24	0A	01	00, 01 (Off, On)
Sustain Lower Length	24	0B	00	24	0B	01	00 - 04 (1 - 5)	
Pedal	Type	25	00	00	25	00	01	00, 01 (Normal, Muted)
	Key Click Mode	25	01	00	25	01	01	00, 01 (Off, U&L)
	Custom Sub Drawbars	25	02	00	25	02	01	00 - 07 (U1 - F4)
	Pedal Sustain On	17	09	00	17	09	01	00, 01 (Off, On)
	Pedal Sustain Length	17	0A	00	17	0A	01	00 - 04 (1 - 5)

Category	Parameter	NRPN		SysEx Address		SysEx Length	Data
		MSB (63)	LSB (62)	MSB to LSB			
Percussion	On	26	00	00	26	00	01 00, 01 (Off, On)
	Harmonic	26	01	00	26	01	01 00, 01 (Second, Third)
	Fast Decay	26	02	00	26	02	01 00, 01 (Slow, Fast)
	Volume Soft	26	03	00	26	03	01 00, 01 (Normal, Soft)
	Level at Soft	26	04	00	26	04	01 00 - 63 (0 - 127)
	Level at Normal	26	05	00	26	05	01 00 - 63 (0 - 127)
	Decay at Fast	26	06	00	26	06	01 00 - 18 (0 - 24)
	Decay at Slow	26	07	00	26	07	01 00 - 18 (0 - 24)
	Touch	26	08	00	26	08	01 00, 01 (Off, On)
	1' Cancel	26	09	00	26	09	01 00, 01 (Off, On)
Drawbar Level	26	0A	00	26	0A	01 00, 01 (0, Soft)	
Animation	Leslie Bypass	27	00	00	27	00	01 00, 01 (Off, On)
	Leslie Stop	27	01	00	27	01	01 00, 01 (Off, On)
	Leslie Fast	27	02	00	27	02	01 00, 01 (Off, On)
	Custom Cabinet	27	03	00	27	03	01 00 - 0F (U1 - P8)
	Vibrato Upper	27	04	00	27	04	01 00, 01 (Off, On)
	Vibrato Lower	27	05	00	27	05	01 00, 01 (Off, On)
	Vibrato Mode	27	06	00	27	06	01 00 - 05 (V1 - C3)
	Vibrato Pedal On	27	07	00	27	07	01 00, 01 (Off, On)
	Vibrato Model	27	08	00	27	08	01 00 - 02 (Big Box, Small Box, Metal Box)
	Vibrato Rate (TW)	27	09	00	27	09	01 00 - 99 (5.78 - 7.90 Hz)
	Vibrato Chorus Mix	27	0A	00	27	0A	01 00 - 7F (0 - 127)
	Vibrato Rate (Transistor)	27	0E	00	27	0E	01 00 - 7F (0 - 127)
Vibrato Rate (Pipe)	27	0F	00	27	0F	01 00 - 7F (0 - 127)	
Leslie On Reverb	27	10	00	27	10	01 00, 01 (Off, On)	
Transformer	Drive Level	28	00	00	28	00	01 00 - 7F (0 - 127)
	Hysteresis	28	01	00	28	01	01 00 - 7F (0 - 127)
	Depth Upper	28	02	00	28	02	01 00 - 7F (0 - 127)
	Depth Percussion	28	03	00	28	03	01 00 - 7F (0 - 127)
	Depth Lower	28	04	00	28	04	01 00 - 7F (0 - 127)
	Depth Pedal	28	05	00	28	05	01 00 - 7F (0 - 127)
	On	28	06	00	28	06	01 00, 01 (Off, On)
Overdrive	On	29	00	00	29	00	01 00, 01 (Off, On)
	Type	29	01	00	29	01	01 00 - 03 (Tube Amp, Stomp Box, Clip, EP Amp)
	Drive Level	29	02	00	29	02	01 00 - 7F (0 - 127)
	Exp. Control On	29	03	00	29	03	01 00, 01 (Off, On)
	Crossover Freq	29	04	00	29	04	01 00 - 7F (400Hz - 14.7kHz)
	Blend	29	05	00	29	05	01 00 - 7F (0 - 127)
Effect 1, Effect 2	On	2x	00	00	2x	00	01 00, 01 (Off, On)
	Type	2x	01	00	2x	01	01 00 - 03 for Effect1, 00 - 04 for Effect 2 00: Tremolo 00: Auto Pan 01: Wah-Wah 01: Phaser 02: Ring Mod 02: Flanger 03: Compressor 03: Chorus 04: Delay
	Param 1	2x	02	00	2x	02	01 00 - 7F (0 - 127)
	Param 2	2x	03	00	2x	03	01 00 - 7F (0 - 127)
	Param 3	2x	04	00	2x	04	01 00 - 7F (0 - 127)
	Param 4	2x	05	00	2x	05	01 00 - 7F (0 - 127)
	Param 5	2x	06	00	2x	06	01 00 - 7F (0 - 127)
	Param 6	2x	07	00	2x	07	01 00 - 7F (0 - 127)
	Param 7	2x	08	00	2x	08	01 00 - 7F (0 - 127)
	Param 8	2x	09	00	2x	09	01 00 - 7F (0 - 127)
Equalizer	Bass Gain	2C	00	00	2C	00	01 00 - 09 - 12 (-9 - ±0 +9)
	Mid Gain	2C	01	00	2C	01	01 00 - 09 - 12 (-9 - ±0 +9)
	Treble Gain	2C	02	00	2C	02	01 00 - 09 - 12 (-9 - ±0 +9)
	Bass Freq	2C	03	00	2C	03	01 00 - 18 (20 - 308Hz)
	Mid Freq	2C	04	00	2C	04	01 00 - 0F (250 - 3.1kHz)
Treble Freq	2C	05	00	2C	05	01 00 - 13 (3.0k - 8.0kHz)	

CUSTOM SETS

CUSTOM TONE WHEELS

TW

F1: B-3 A27563

B-3, serial number #A27563.

F2: B-3 #364839

B-3, serial number #364839.

F3: A-102 #35564

A-102, serial number #35564.

F4: Mellow

No leakage tones, wow, flutter or wheel eccentricity.

CUSTOM SUB DRAWBARS

F1: B-3 A27563

F2: B-3 #364839

F3: A-102 #35564

F4: Solid

Each Custom setting replicates the organ shown above. "Solid" refers to a generic electronic organ.

CUSTOM LESLIE CABINETS

F1: 122 Gentle

Replicates 122 cabinet (Large body, peaking horn driver) heard from a distance, rear.

F2: 122 Wild

Replicates 122 cabinet heard from a closer distance, front.

F3: 122 Hot

Replicates 122 cabinet with deeper modulation, rear.

F4: 122 Bass Stop

Replicates 122 cabinet with stopped bass(drum) rotor, front.

F5: 147 Gentle

Replicates 147 cabinet (Large body, wide range) heard from a distance.

F6: 147 Wild

Replicates 147 cabinet heard from a closer distance, front.

F7: 145 Gentle

Replicates 145 cabinet (Middle body, slightly narrow range) heard from a distance, rear.

F8: 145 Wild

Replicates 145 cabinet heard from a closer distance, front.

CUSTOM PIPES

F1: Classic 1

Classical or Liturgical stops.

F2: Classic 2

A Classical Pipe set suitable for Baroque music (Bach, Buxtehude, etc.).

F3: Theatre 1

Theatre stops based on Wurlitzer Style 210.

F4: Theatre 2

Theater stops based on Wurlitzer Style 260 Special.

CUSTOM TONE WHEEL PARAMETERS

Category	Parameter	SysEx Address			SysEx Length	Data	Description
		MSB	to	LSB			
Temporary Tone Wheels	Name	--	--	--	--	(10 characters)	
	Foldback Low	10	00	01	01	00 - 0C (TW#01 - #12)	
	Foldback High	10	00	02	01	00 - 05 (TW#91 - #96)	
	Wheel Level	10	01	tt	02	00 00 - 05 01 (0 - 641: -inf, -60.0 - +4.0[dB])	tt: Tone Wheel number; 00 - 0B (#01 - #12), 0C - 17 (#F01 - F12), 18 - 66 (#13 - #91), 67 - 6B (#F92 - #F96)
	Leak Trim	10	03	tt	01	00 - 7F (0 - 127)	
	Wow Flutter Depth	10	04	tt	01	00 - 7F (0 - 127)	
	Wow Flutter Speed	10	05	tt	01	00 - 7F (0 - 127)	
	Eccentricity Depth	10	06	tt	01	00 - 7F (0 - 127)	
	Eccentricity Speed	10	07	tt	01	00 - 7F (0 - 127)	
	Complex LPF	10	08	00	01	00 - 7F (0 - 127)	
	Matrix Level	2p	nn	0g	02	00 00 - 05 01 (0 - 641: -inf, -60.0 - +4.0[dB])	p: Part (0 = UPPER, 1 = Lower, 2 = Percussion, 3 = Pedal) nn: Note number g: Footage (p = 0 - 2); 0 = 16', 1 = 5 1/3' ... 8 = 1' g: Footage (p = 3); 0 = 16' - 16', 1 = 16' - 5 1/3' ... 7 = 16 - 1 1/3' 8 = 8' - 16', 9 = 8' - 5 1/3' ... 15 = 16 - 1 1/3'
	Leak Level	3p	tt	ll	02	00 00 - 05 01 (0 - 641: -inf, -60.0 - +4.0[dB])	tt: Fundamental TW #; 00 - 5F (#01 - #96) ll: Leaking TW #; 00 - 5F (#01 - #96)

CUSTOM PEDAL REG. PARAMETERS

Category	Parameter	SysEx Address			SysEx Length	Data	Description
		MSB	to	LSB			
Temporary Pedal Sub Drawbars	Name	--	--	--	--	(10 characters)	
	Normal 16' - 16'	50	00	01	01	00 - 08 (0 - 8)	
	Normal 16' - 5 1/3'	50	00	02	01	00 - 08 (0 - 8)	
	Normal 16' - 8'	50	00	03	01	00 - 08 (0 - 8)	
	Normal 16' - 4'	50	00	04	01	00 - 08 (0 - 8)	
	Normal 16' - 2 2/3'	50	00	05	01	00 - 08 (0 - 8)	
	Normal 16' - 2'	50	00	06	01	00 - 08 (0 - 8)	
	Normal 16' - 1 3/5'	50	00	07	01	00 - 08 (0 - 8)	
	Normal 16' - 1 1/3'	50	00	08	01	00 - 08 (0 - 8)	
	Normal 8' - 16'	50	00	09	01	00 - 08 (0 - 8)	
	Normal 8' - 5 1/3'	50	00	0A	01	00 - 08 (0 - 8)	
	Normal 8' - 8'	50	00	0B	01	00 - 08 (0 - 8)	
	Normal 8' - 4'	50	00	0C	01	00 - 08 (0 - 8)	
	Normal 8' - 2 2/3'	50	00	0D	01	00 - 08 (0 - 8)	
	Normal 8' - 2'	50	00	0E	01	00 - 08 (0 - 8)	
	Normal 8' - 1 3/5'	50	00	0F	01	00 - 08 (0 - 8)	
	Normal 8' - 1 1/3'	50	00	10	01	00 - 08 (0 - 8)	

PIPE PARAMETERS

Category	Parameter	SysEx Address			SysEx Length	Data	Description
		MSB	to	LSB			
Pipes	Name	--	--	--	--	(10 characters)	
	Assign	40	01	pp	02	00 00 - 00 2D (C-Open Diapason - P-Cornocean)	pp: Pipe Stop number 00 - 13 (#01 - #20)
	Tremulant	40	02	pp	01	00, 01 (Off, On)	
	Footage	40	03	pp	01	00 - 09 (32' - 1')	
	Volume	40	04	pp	02	00 00 - 01 41 (0 - 193: -inf, -92.0 - +4.0[dB])	
	Detune	40	05	pp	02	3F 4E - 40 00 - 40 32 (-50 - ±0 - +50[cent])	
	Chiff	40	06	pp	01	00 - 03 (Off, Soft, Normal, Loud)	
	Cut Off Frequency	40	07	pp	02	3F 01 - 40 00 (-127 - 0)	
	Pan - Direction	40	08	pp	01	00 - 40 - 7F (L64 - Center - R63)	
	Pan - Imaging	40	09	pp	01	00 - 04 (Fixed, L-R, R-L, Pyramid, Inverted Pyramid)	

CUSTOM LESLIE PARAMETERS

Category	Parameter	NRPN		SysEx Address			SysEx Length	Data
		MSB (63)	LSB (62)	MSB	to	LSB		Data length 01 uses MSB only, length 02 uses MSB and LSB.
Cabinet	Name	--	--	--	--	--	--	(10 Characters)
	Speaker	06	17	00	06	17	01	00 - 07 00: 145 Front 04: 122 Front 01: 145 Rear 05: 122 Rear 02: 147 Front 06: Cone Type 03: 147 Rear 07: PR-40
	Slow Speed Horn	06	01	00	06	01	02	00 00, 00 01 - 00 65 (0, 20 - 120 rpm)
	Slow Speed Drum	06	02	00	06	02	02	00 00, 00 01 - 00 65 (0, 20 - 120 rpm)
	Fast Speed Horn	06	03	00	06	03	02	00 00, 00 01 - 02 2D (0, 200 - 500 rpm)
	Fast Speed Drum	06	04	00	06	04	02	00 00, 00 01 - 02 2D (0, 200 - 500 rpm)
	Rise Time Horn	06	09	00	06	09	01	00 - 24 (0.8 - 12.5 sec)
	Rise Time Drum	06	0A	00	06	0A	01	00 - 23 (1.0 - 12.5 sec)
	Fall Time Horn	06	0B	00	06	0B	01	00 - 24 (0.8 - 12.5 sec)
	Fall Time Drum	06	0C	00	06	0C	01	00 - 23 (1.0 - 12.5 sec)
	Brake Time Horn	06	0D	00	06	0D	01	00 - 24 (0.8 - 12.5 sec)
	Brake Time Drum	06	0E	00	06	0E	01	00 - 23 (1.0 - 12.5 sec)
	Delay Time Horn	06	0F	00	06	0F	01	00 - 05 (0.0 - 1.0 sec)
	Delay Time Drum	06	10	00	06	10	01	00 - 05 (0.0 - 1.0 sec)
	Mic. Width Horn	06	11	00	06	11	01	00 - 64 (0 - 100 cm)
	Mic. Width Drum	06	12	00	06	12	01	00 - 64 (0 - 100 cm)
	Mic. Center Horn	06	05	00	06	05	01	0E - 40 - 72 (-50 - ±0 - +50 cm)
	Mic. Center Drum	06	06	00	06	06	01	0E - 40 - 72 (-50 - ±0 - +50 cm)
	Mic. Distance Horn	06	07	00	06	07	02	00 1E - 01 48 (30 - 200 cm)
	Mic. Distance Drum	06	08	00	06	08	02	00 1E - 01 48 (30 - 200 cm)
	Level Horn	06	13	00	06	13	01	00, 01 - 4D (-Inf, -76 - 0 dB)
	Level Drum	06	14	00	06	14	01	00, 01 - 4D (-Inf, -76 - 0 dB)
	Level Sub Bass	06	15	00	06	15	01	00, 01 - 4D (-Inf, -76 - 0 dB)

SYSTEM PARAMETERS

Category	Parameter	NRPN		SysEx Address			SysEx Length	Data
		MSB (63)	LSB (62)	MSB to LSB				
Tune	Master Tune	01	00	00	01	00	02	032E - 0338 - 0342 (A= 430 - 440 - 450 Hz)
	Transpose	01	01	00	01	01	02	3F 7A - 40 00 - 40 06 (-6 - ±0 - +6 semitones)
	Velocity Offset	01	02	00	01	02	02	3F 60 - 40 00 - 40 20 (-32 ±0 - +32)
	Organ Sounding Point	01	04	00	01	04	01	00, 01 (Shallow, Deep)
	TW Brake Range	01	05	00	01	05	02	3F 68 - 40 00 - 40 0C (-24 - ±0 - +12 semitones)
	TW Brake Time	01	06	00	01	06	01	00 - 31 (0.1 - 5.0s)
	TW Brake Amp	01	07	00	01	07	01	00, 01 (Off, On)
	Transpose Act	01	08	00	01	08	01	00, 01 (Every, Next)
Expression	Source	02	00	00	02	00	01	00 - 02 (Pedal, MIDI, Both)
	Min. Level	02	01	00	02	01	01	00 - 29 (Off, -40 - ±0dB)
	Min. Limit LF	02	02	00	02	02	01	00 - 29 (Off, -40 - ±0dB)
	Min. Limit HF	02	03	00	02	03	01	00 - 29 (Off, -40 - ±0dB)
	Pedal Type	02	06	00	02	06	01	00, 01 (H or R, Y or K)
	Gain	02	07	00	02	07	01	00 - 3C (70 - 130 %)
	Curve	02	08	00	02	08	01	00 - 02 (Audio, Linear, Capacitor)
Damper	Pedal Type	03	03	00	03	03	01	00 - 03 (Switch, HalfY, HalfR, HalfK)
	Gain	03	04	00	03	04	01	00 - 3C (70 - 130 %)
Foot Switch	Mode Tip	07	00	00	07	00	01	00 - 24
	Mode Ring	07	01	00	07	01	01	00: Off 01: Leslie S/F Alt 02: Leslie S/F Mom 03: Leslie S/F Tri 04: TW Brake 05: Favorite Fwd 06: Favorite Rev 07: Spring Shock 08: MFX2 Delay Time 09: U&L Sustain 0A: Pedal To Lower 0B-23: Bass 1C - 3C
User Button	Mode	08	00	00	08	00	01	00 - 08 00: Off 01: Pedal Sustain 02: Upper Sustain 03: Lower Sustain 04: TW Brake 05: Spring Shock 06: MFX2 Delay Time 07: MFX1 08: MFX2
Display	Short Cut	--	--	--	--	--	--	00 - 03 (0, 1, 2 sec, No)
	Time Out	--	--	--	--	--	--	00 - 03 (4, 8, 16 sec, No)
	Pop Up	--	--	--	--	--	--	00 - 03 (No, 5, 10, 20 sec)
	Auto Power Off	--	--	--	--	--	--	00, 01 (Disable, 30min)
	Knobs	--	--	--	--	--	--	00, 01 (Every, Across)
	USB Mass Storage	--	--	--	--	--	--	00, 01 (Off, On)
Audio	Ext. Leslie Ch.	04	01	00	04	01	01	00 - 02 (1, 1,w/Pre, 3)
	Use Rotary Out	04	02	00	04	02	01	00, 01 (Off, On)
	Use Pedal Out	04	03	00	04	03	01	00, 01 (Off, On)
Master Equalizer	Bass Gain	05	01	00	05	01	01	00 - 09 - 12 (-9 - ±0 +9)
	Mid Gain	05	02	00	05	02	01	00 - 09 - 12 (-9 - ±0 +9)
	Treble Gain	05	03	00	05	03	01	00 - 09 - 12 (-9 - ±0 +9)
	Bass Freq	05	04	00	05	04	01	00 - 18 (20 - 308Hz)
	Mid Freq	05	05	00	05	05	01	00 - 0F (125 - 4kHz)
	Treble Freq	05	06	00	05	06	01	00 - 13 (3.0k - 8.0kHz)
	Mid Q	05	07	00	05	07	01	00 - 3F (0 - 63)
MIDI Common	MIDI In Mode	--	--	--	--	--	--	00 - 09 00: Upper 01: Lower 02: Pedal 03: Lower+Pedal 04: Upper+Pedal 05: Organ Upper 06: Piano 07: Ensemble 08: Synth 09: Sequencer
	Local Control	--	--	--	--	--	--	00, 01 (Off, On)
	TRx Individual Parameters	--	--	--	--	--	--	00 - 02 (Off, NRPN, SysEx)
	TRx Program Change	--	--	--	--	--	--	00, 01 (Off, On)
	TRx Drawbar Regi	--	--	--	--	--	--	00, 01 (Off, On)
	Tx External Zone	--	--	--	--	--	--	00, 01 (Off, On)
	Device ID	--	--	--	--	--	--	00 - 7F (0 - 127)
	Rx Dump	--	--	--	--	--	--	00, 01 (Off, On)
	Tx Upper	--	--	--	--	--	--	00 - 0F (1 - 16)
	Tx Lower	--	--	--	--	--	--	00 - 0F (1 - 16)
Tx Pedal	--	--	--	--	--	--	00 - 0F (1 - 16)	
Rx Upper	--	--	--	--	--	--	00 - 0F (1 - 16)	
Rx Lower	--	--	--	--	--	--	00 - 0F (1 - 16)	
Rx Pedal	--	--	--	--	--	--	00 - 0F (1 - 16)	

Category	Parameter	NRPN		SysEx Address			SysEx Length	Data
		MSB (63)	LSB (62)	MSB to LSB				
Patch Load	Registration L/P	60	01	00	60	01	01	00, 01 (Off, On)
	Internal Zone	60	02	00	60	02	01	00, 01 (Off, On)
	External Zone	60	03	00	60	03	01	00, 01 (Off, On)
	Organ Effect	60	04	00	60	04	01	00, 01 (Off, On)
	Animation	60	05	00	60	05	01	00, 01 (Off, On)
	Reverb	60	06	00	60	06	01	00, 01 (Off, On)
	Drawbar	60	07	00	60	07	01	00, 01 (Off, On)
	Percussion	60	08	00	60	08	01	00, 01 (Off, On)
	Registration Upper	60	09	00	60	09	01	00, 01 (Off, On)
	Control	60	0A	00	60	0A	01	00, 01 (Off, On)
Assign	60	0B	00	60	0B	01	00, 01 (Off, On)	

FAVORITES

Category	Parameter	SysEx Address			SysEx Length	Data	Default	Description
		MSB	LSB	On				
Favorites	Assign	73	0b	0n	02	00 00 - 00 63 (U1-1 - U10-10), 00 64 - 01 47 (F1-1 - F10-10)	same as Patch#	b: Bank 0 - 9 (1 - 10) n: Number 0 - 9 (1 - 10)

Example Set 5-2 at U1-5 via System ExclusiveF0 55 dd 10 25 13 73 04 01 00 04 F7 (dd = Device ID)

MIDI IMPLEMENTATION CHART

Drawbar Keyboard
Model: XK-4

MIDI Implementation Chart

Date: 7-Feb-2023
Version: 1.0

Function		Transmitted	Recognized	Remarks
Basic Channel	Default Changed	*1 1 - 16	*1 1 - 16	*1: Upper = 1, Lower = 2, Pedal = 3 when MIDI Template is recalled at "Basic".
Mode	Default Messages Altered	3 X *****	3 X 1	Switched by MIDI IN Mode.
Note Number	: True Voice	12 - 120 (61 key)*2 *****	0 - 127 0 - 127	*2: with oct. shift
Velocity	Note ON Note OFF	O O	O O	
After Touch	Key's Ch's	X X	X X	
Pitch Bend		O	O	
Control Change	0, 32	O	O	Bank Select MSB, LSB
	1	O	O	Modulation
	6, 38	O	O	Data Entry MSB, LSB
	7	O	O	Volume
	10	O	X	Pan
	11	O	O	Expression
	12 - 20	O	O	Drawbar Reg. Upper
	21 - 29	O	O	Drawbar Reg. Lower
	33, 35	O	O	Drawbar Reg. Pedal
	48	O	O	Spring Shock
	49	O	O	TW Brake
	64	O	O	Damper
	69	O	O	Sustain
	92	X	O	Leslie Fast
98, 99	O	O	NRPN LSB, MSB	
Program Change	: True #	O 0 - 127	O 0 - 99, 127	
System Exclusive		O	O	
System Common	: Song Position : Song Select : Tune	X X X	X X X	
System Real Time	: Clock : Commands	X X	X X	
Aux Messages	: All Sounds Off : Reset All Controllers : Local On/Off : All Notes Off : Active Sense : Reset	X O X O O X	O O X O O X	(120) (121)

Mode 1: OMNI ON, POLY Mode 2: OMNI ON, MONO
Mode 3: OMNI OFF, POLY Mode 4: OMNI OFF, MONO

O: Yes
X: No

	External Zone (Tx. only)	Upper Keyboard	Lower Keyboard	Pedal Keyboard
Note	O	O	O	O
Pitch Bend	O	O	X	X
Modulation	O	O	X	X
Volume (7)	O	O *1*2	X	X
Pan (10)	O	X	X	X
Expression (11)	O	O *1	X	X
Damper (64)	O	O	O	O
Sustain (69)	X	O	X	X
Drawbar Reg.	X	12 - 20 (Upper) 21 - 29 (Lower) 33, 35 (Pedal)	X	X
Spring Shock (48)	X	O	X	X
TW Brake (49)	X	O	X	X
Leslie Fast (92)	X	O *2	X	X
RPN (100, 101)	X	X	X	X
NRPN (98, 99)	X	O	X	X
All Notes Off (123)	O	O	X	X
All Sounds Off (120)	X	O *2	X	X
Reset All Ctrl. (121)	O	O	X	X
Bank Select (0, 32)	Change the voice for each zone.	Patch#	X	X
Program Change			X	X

*1: Affects all Parts (audio controlled)

*2: For Rx. only.

Sound Engine**ORGAN Section**

MTWII (Modeled Tone Wheel II), Polyphony: 61 (Tone Wheel Organ)

Keyboard

61 note, with velocity, semi-weighted, square-front (“waterfall” type)

ORGAN Section**Parts**

3 (Upper, Lower, Pedal)

Drawbars

1 set, 9 pitches

Organ Types

Upper & Lower: 5(TW, Vx., Farf, Ace, Pipe)

Pedal: 3 (Normal, Muted, Pipe)

Percussion

Buttons: On, Volume Soft, Fast Decay, Third Harmonic

Others

Virtual Multi Contact, Sustain

Effects**Patch**

Vibrato & Chorus, Multi Effect 1, Overdrive, Multi Effect 2, Matching Transformer, Leslie, Equalizer & Tone Control, Reverb

Master

Equalizer

Key Map**Internal Zone**

Transpose, Octave, Split, Pedal To Lower

External Zones

3 Zones (assignable to each keyboard)

Controllers

Pitch Bend Wheel, Modulation Wheel, Leslie (Bypass, Stop, Fast)

Assign Knob 1/2, Assign Button 1/2, User Button

Memory**Favorites**

Patches: 10 banks x 10 numbers

Display Pages: 10 numbers

Patch

Factory: 100, User: 100, Manual

Custom Tone Wheel

Factory: 4, User: 4

Custom Pedal Registration

Factory: 4, User: 4

Custom Pipe

Factory: 4, User: 4

Custom Cabinet

Factory: 8, User: 8

Storage

USB Flash Drive

Display

320 x 240 pixels

Connections**MIDI**

IN, OUT

USB

To Host

Audio

Line Out L, R, Headphones, Rotary Out, Organ Pedal Out, Aux In (with Volume control)

Leslie

11 - pin, 1 and 3 channels available

Others

Leslie Switch, Foot Switch, Damper Pedal, Expression Pedal

Dimensions

1004(W), 322(D), 109(H) mm

39.5”(W), 12.7”(D), 4.3”(H)

Weight

9.4 kg

20.7 lbs

Accessory

AC Power Cord

A

Ace 43
Allocate 89
Animation 72
App Menu 56
Assign 87
Audio 107
Auto Pan 80
Auto Power Off 24
Aux In 19

B

Back Up 24
Bank 89

C

Chiff 103
Chorus 82
Compressor 78
Contact 70, 71
Control 108
Controller 86
Crossover Frequency 79
Cursor 60
Custom Leslie 100
Custom Pedal Reg. 99
Custom Pipe 102
Custom Tone Wheels 94
Cutoff Frequency 103

D

Damper 86, 90, 110
Damper Pedal 28
Default 119
Delay 83
Delete 141
Drawbar Registration 38
Drawbars. See: Harmonic Drawbars

E

Effect/EQ 74
Envelope 71
Equalizer 106
Expression 90
Expression Pedal 28, 109
External Zone Channels 126
External Zones 89

F

Factory 25
Factory Settings 24
Farf 43

Favorites 25, 63, 116
Flanger 81
Footage 38, 102
Foot Switch 28
Function Mode 60

G

General 67
Global 115

H

Harmonic Drawbars 38

I

Icon 60
Image 103
Impedance 70
Information 120
Initialize 56
Is Active 120

K

Keyboard 113
Keyboard Channels 126
Key Range 67, 89

L

Leakage Tone 68
Leslie 73
Leslie Speaker 17
Leslie Switch 22, 28
List Window 60
Load 140
Lock 55
Lower 25

M

Manual 30, 52
Master Equalizer 29
Master Tune 51
Matching Transformer 74
Menu Mode 58
MIDI 124, 132
MIDI Channel 89, 133
MIDI Sound Module 129
MIDI Template 132, 148
Modulation 28, 86, 90
Multi Effects 75, 80
Music Player 19

O

Octave 48, 67, 88, 89

P

Page 60
Pan 90, 103
Panel 112
Parameter 60
Part 25
Patch 25, 66
Patch Equalizer 85
Patch Load 114
Pedal 25
Pedal Out 18
Pedal Sustain 49, 70
Pedal To Lower 48
Percussion 71
Phaser 81
Pipe 44
Pitch Bend 28, 86, 90
Play Mode 56

Q

Q 106

R

Record 104, 118
Reverb 84
Ring Modulation 77
Rotary Out 18

S

Save 139
Setup File 138
Sound 106
Sounding Point 113
Split 48, 88
Stop 44, 47
Sustain 70
System Exclusive Messages 133, 151

T

Tone Control 85
Tone Wheel Brake 111
Transpose 51, 89
Tremolo 75
Tremulant 72

U

Update 121
Upper 25
USB 124
USB Flash Drive 136
User 25, 28, 111

V

Value 60
Velocity 70, 90
Velocity Offset 113
Version 120
Vibrato & Chorus 72
Volume 67, 90, 102
Vx 42

W

Wah-Wah 76

Hammond maintains a policy of continuously improving and upgrading its instruments and therefore reserves the right to change specifications without notice. Although every attempt has been made to insure the accuracy of the descriptive contents of this Manual, total accuracy cannot be guaranteed.

Should the owner require further assistance, inquiries should first be made to your Authorized Hammond Dealer. If you still need further assistance, contact Hammond at the following addresses:

**In the United States Contact:
HAMMOND SUZUKI USA, Inc.**

219 W. Wrightwood Ave.
Elmhurst, Illinois 60126
UNITED STATES
Tel: (630) 543-0277
Fax: (630) 543-0279

Web site: <https://hammondorganco.com>
Contact: [https://hammondorganco.com/
contact-us/](https://hammondorganco.com/contact-us/)

Product Registration

[https://hammondorganco.com/product-
registration/](https://hammondorganco.com/product-registration/)



**In European countries contact:
HAMMOND SUZUKI EUROPE B. V.**

IR. D. S. Tuynmanweg 4a 4131 PN Vianen
THE NETHERLANDS
Tel: (+31) 347-370 594

Web site: www.hammond.eu
Contact: [www.hammond.eu/Contact/
ContactPage](http://www.hammond.eu/Contact/ContactPage)

Product Registration

www.hammond.eu/Contact/RegistrationPage



**For other countries:
SUZUKI CORPORATION**

2-25-7, Ryoke, Naka-ku, Hamamatsu,
Shizuoka Pref. 430-0852
JAPAN
Tel: (+81) 53-460-3781
Fax: (+81) 53-460-3783

Contact

<https://suzukimusic-global.com/contact.php>



Manufacturer:

SUZUKI MUSICAL INSTRUMENT MFG. Co., Ltd.

2-25-7, Ryoke, Naka-ku, Hamamatsu, Shizuoka Pref. 430-0852
JAPAN

